



Primeon

Compact, single-phase test van system

OPERATION AND MAINTENANCE

Issue: 1 (03/2024) - EN
Article number: 87350

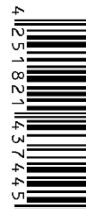

Terms of Warranty

Megger accept responsibility for a claim under warranty brought forward by a customer for a product sold by Megger under the terms stated below.

Megger warrant that at the time of delivery Megger products are free from manufacturing or material defects which might considerably reduce their value or usability. This warranty does not apply to faults in the software supplied. During the period of warranty, Megger agree to repair faulty parts or replace them with new parts or parts as new (with the same usability and life as new parts) according to their choice.

This warranty does not cover wear parts, lamps, fuses, batteries and accumulators.

Megger reject all further claims under warranty, in particular those from consequential damage. Each component and product replaced in accordance with this warranty becomes the property of Megger.

All warranty claims versus Megger are hereby limited to a period of 12 months from the date of delivery. Each component supplied by Megger within the context of warranty will also be covered by this warranty for the remaining period of time but for 90 days at least.

Each measure to remedy a claim under warranty shall exclusively be carried out by Megger or an authorized service station.

This warranty does not apply to any fault or damage caused by exposing a product to conditions not in accordance with this specification, by storing, transporting, or using it improperly, or having it serviced or installed by a workshop not authorized by Megger. All responsibility is disclaimed for damage due to wear, will of God, or connection to foreign components.

For damage resulting from a violation of their duty to repair or re-supply items, Megger can be made liable only in case of severe negligence or intention. Any liability for slight negligence is disclaimed.

Since some states do not allow the exclusion or limitation of an implied warranty or of consequential damage, the limitations of liability described above perhaps may not apply to you.

Contents

1	Safety and general information	5
1.1	Basic information.....	5
1.2	General warnings and safety instructions	7
2	Technical description	9
2.1	System description.....	9
2.2	Technical data	13
3	Safety devices	24
4	Setting up and connecting the test van	26
4.1	Setting up and securing the test van.....	26
4.2	Electrical connection	27
4.2.1	Connection equipment	28
4.2.2	Connection of the earth cable	29
4.2.3	Connecting the reference earth (F-U monitoring)	30
4.2.4	Connection to the test object	31
4.2.4.1	Using the HV connection cable.....	31
4.2.4.2	Using the three-phase LV connection cable (optional)	37
4.2.5	Establishing the mains supply.....	38
4.2.5.1	Connection to mains supply	38
4.2.5.2	Operation via generator or battery power supply (optional).....	39
4.2.6	Connection of the external safety device	40
4.3	Switching on the test van	42
5	Operation of the test van.....	43
5.1	Operating unit.....	43
5.2	Other operating and connecting elements in the control area	45
5.3	Switch on.....	46
5.4	Resolving signaled problems	47
5.5	Operation	49
6	Work after completion of the measurement job	50
7	IT accessories and connectivity	52
7.1	Use of USB accessories	52
7.2	Internet and GPS connectivity (optional)	53
8	Troubleshooting	56
8.1	Behaviour in the event of faults during normal operation	56
8.1.1	Check fuses	56
8.1.2	Other possible fault causes.....	58
8.2	Behaviour in the event of continuous faults	59
9	Care and maintenance.....	60
9.1	Testing and maintenance measures to be carried out by the operator	60
9.2	Required maintenance by a service workshop	60

1 Safety and general information

1.1 Basic information





Safety precautions

This manual contains basic instructions for the commissioning and operation of the device / system. For this reason, it is important to ensure that the manual is always available to the authorised and trained operator. He needs to read the manual thoroughly. The manufacturer is not liable for damage to material or humans due to non-observance of the instructions and safety advices provided by this manual.

Locally applying regulations have to be observed!

Signal words and symbols used

The following signal words and symbols are used in this manual and on the product itself:

Signal word / symbol	Description
DANGER	Indicates a potential hazard which <u>will result</u> in death or serious injury if not avoided.
WARNING	Indicates a potential hazard which <u>may result</u> in death or serious injury if not avoided.
CAUTION	Indicates a potential hazard which may result in moderate or minor injury if not avoided.
NOTICE	Indicates a potential hazard which may result in material damage if not avoided.
	Serves to highlight warnings and safety instructions. As a warning label on the product it is used to draw attention to potential hazards which have to be avoided by reading the manual.
	Serves to highlight warnings and safety instructions that explicitly indicate the risk of an electric shock.
	Serves to highlight important information and useful tips on the operation of the device/system. Failure to observe may lead to unusable measurement results.
	Serves as a reference to further information in other operating instructions.

Working with products from Megger

It is important to observe the generally applicable electrical regulations of the country in which the device will be installed and operated, as well as the current national accident prevention regulations and internal company directives (work, operating and safety regulations).

After working on the system, it must be voltage-free and secured against reconnection as well as having been discharged, earthed and short-circuited.

Use genuine accessories to ensure system safety and reliable operation. The use of other parts is not permitted and invalidates the warranty.

Operating staff

The system may only be installed and operated by an authorised electrician. DIN VDE 0104 (EN 50191), DIN VDE 0105 (EN 50110) and the German accident prevention regulations (UVV) define an electrician as someone whose knowledge, experience and familiarity with the applicable regulations enables him to recognise potential hazards.

Anyone else must be kept away!

Electromagnetic radiation

This device is designed for industrial use. When used at home it could cause interference to other equipment, such as the radio or television.

The interference level from the line complies with the limit curve B (living area), the radiation level complies with the limit curve A (industrial area) according to EN 55011. Given that living areas are sufficiently far away from the planned area of operation (industrial area), equipment in living areas will not be impaired.

1.2 General warnings and safety instructions

Intended application

The operating safety is only guaranteed if the delivered system is used as intended. Incorrect use may result in danger to the operator, to the system and the connected equipment.

The thresholds listed in the technical data may not be exceeded under any circumstances.

Operation in traffic environment

To ensure safety for operators and traffic, the country-specific regulations must be observed.

Five safety rules

The five safety rules must always be followed when working with HV (High Voltage):

1. De-energise
2. Protect against re-energising
3. Confirm absence of voltage
4. Earth and short-circuit
5. Cover up or bar-off neighbouring energised parts



Using cardiac pacemaker / defibrillator

Physical processes during operation of high voltage may endanger persons wearing a cardiac pacemaker or defibrillator when near these high voltage facilities.



Fire fighting in electrical installations

- According to regulations, **carbon dioxide (CO₂)** is required to be used as extinguishing agent for fighting fire in electrical installations.
- Carbon dioxide is electrically non conductive and does not leave residues. It is safe to be used in energized facilities as long as the minimum distances are maintained. A CO₂ fire extinguisher must be always available within electrical installations.
- If, contrary to the regulations, any other extinguishing agent is used for fire fighting, this may lead to damage at the electrical installation. Megger disclaims any liability for consequential damage. Furthermore, when using a powder extinguisher near high-voltage installations, there is a danger that the operator of the fire extinguisher will get an electrical shock from a voltage arc-over (due to the powder dust created).
- It is essential to observe the safety instruction on the extinguishing agent.
- Applicable is DIN VDE 0132.



WARNING

Dangers when working with high voltage

Working on high voltage systems and equipment – especially in non-stationary operation – requires particular care and safety-conscious action on the part of operating personnel. VDE regulations 0104 on setting up and operating electrical test systems, as well as EN 50191 and national standards and regulations must be strictly adhered to.

- The Primeon generates a dangerous voltage up to 62 kV during the measuring operation. This is fed into the test object via the HV connection cable.
- The test system may not be operated without supervision.
- Never fail to use safety equipment or put it out of operation.
- Operation requires minimum two people whereas the second person must be able to activate the emergency switch in case of danger.
- To prevent dangerous charge accumulation, earth all metal parts in the vicinity of the high voltage equipment.



Wear ear protection

Surge operation can cause high and sudden noise levels. It is strongly recommended to wear hearing protection during surge operation. Keep in mind that this will limit the operators awareness for ambient dangers.



Due to the increased formation of ozone, sufficient fresh air must be supplied to the operating room during operation.



Objects should not be placed on or lent against the heater, nor pushed between the heater and wall.

Do not cover the air exit or leave any combustible material in close vicinity to the heater.



Peripheral devices

Please follow the safety instructions of the peripheral devices (e.g. heater) installed in the system environment. For all peripheral devices provided by Megger, the instructions manual is included in the scope of delivery. Megger is not liable for damage to material or humans due to misuse of these devices.

2 Technical description

2.1 System description

The Primeon is a cable testing system intended for installation in a van, trailer or container, the basis of which is the STX 40 cable fault location system. The vehicle installation carried out by Megger itself or by following clear specifications enables rapid transportation, eliminating interference when time is of critical importance without having to unload the system from the vehicle at the deployment location. This is also ensured by the connection and safety technology integrated into the vehicle, which offers the user the familiar high degree of comfort and safety.

Optionally, the vehicle can also be equipped with powerful VLF testing technology and modern diagnostic systems that enable standard-compliant cable testing and partial discharge diagnostics.

The system is operated almost exclusively by a central control unit (with integrated TDR module), which is also responsible for the automatic storing and logging of test results. All system functions, measurement results, operating instructions and error messages are shown on a single display.



Features

The **basic configuration with STX 40** makes the system suitable for the following measuring tasks:

- DC test/trip detection up to 40 kV
- Insulation test up to 20 kV
- Fault detection with proven HV pre-locating methods such as
- Arc Reflection Measurement (ARM), voltage decoupling (Decay) and
- Induced Current Elimination (ICE)
- Fault conversion by burning at the fault location with up to 850 mA
- Sheath test with up to 20 kV with automatic breakdown detection
- Pinpoint location of sheath faults according to the step voltage method with up to 20 kV
- Pinpoint fault location in surge mode with up to 2000 J















Depending on the add-on equipment, the following measurement and diagnostic applications are also available as **options**:











- VLF test with cosine rectangular and/or sinusoidal voltage
- Burning at the fault location with simultaneous fault detection (ARM burning)
- Line and fault detection by means of audio frequency signal
- TanDelta loss factor measurement
- Partial discharge diagnostics

In addition to the mentioned measurement and diagnostic technologies, the system offers the following features:

- Highest safety standards
- Intuitive operation via touch display
- Workflow-supported automation of typical measuring and testing processes
- High system stability thanks to the Linux® operating system
- TDR-Performance-Upgrade „TDR Unleashed“ for higher pulse amplitudes, more pulse width, state-of-the-art interference and noise suppression technologies and "Signature Boost" for long ranges
- Self-powered (optional)
- Integrated protocol software with cable database for instant reporting (optional)
- Wireless communication interfaces (4G, WiFi, GPS) (optional)
- Transfer and synchronisation of measurement and cable data via a cloud database (optional)
- Remote control of important pinpointing and line location methods via app (optional)
- TeamViewer remote access for support and demonstration purposes (optional)

Equipment matrix

		Basic system	Optional
Test			
Insulation test		via HV cable	
			via LV cable
DC voltage test		up to 40 kV	
VLF test with cosine rectangular voltage			with TDM 4540 (up to 40 kV _{RMS}) with TDM 6260 (up to 60 kV _{RMS})
VLF test with sinusoidal voltage			with TDM 45 (up to 45 kV _{peak}) with TDM 62 (up to 62 kV _{peak})
Test with trapezoidal AC voltage (rectangular voltage)			with TDM 45 (up to 45 kV _{peak}) with TDM 62 (up to 62 kV _{peak})
Sheath test		up to 20 kV	
Fault location			
Pulse reflection measurement		via HV cable	
			via LV cable
Pulse reflection measurement in the event of intermittent errors		via HV cable	
			via LV cable
ARM Multishot (arc reflection measurement)		■	
DECAY method		up to 40 kV	
ICE current pulse method		■	
ARM burning			with burn unit 15 kV

		Basic system	Optional
Fault conversion			
Burning		up to 20 kV	
			with burn unit 15 kV
Fault pinpointing			
Surging		8/16/32 kV @ 2000 J	4 kV with 1100 J
Audio frequency generator			200 W
Sheath fault pinpointing		up to 20 kV	
PD Pinpointing			with PD-TX pulse transmitter and three-phase LV connection cable
Diagnostics			
Dielectric strength test with simultaneous tan delta measurement			with TDM + internal or external TanDelta sensor
TanDelta step test			
PD diagnostics with sinusoidal voltage			TDM + partial discharge coupler (PDS 60(-HP) or PDS 62-SIN)
PD diagnostics with cosine rectangular voltage			TDM (TDM 4540 or TDM 6260) + PD coupler PDS 60(-HP)
PD diagnostics with DAC voltage			TDM (TDM 4540 or TDM 6260) + PD coupler PDS 60(-HP)

2.2 Technical data



Technical data for the additional measurement technology (e.g. PDS 60, Ferrolux receiver) and for the peripheral devices (e.g. generator system) available for the test van can be found in the respective operating instructions.

General data of the vehicle's technical equipment

Parameter	Value
Mains voltage	230 V, 50 Hz or 120 V, 60 Hz Connection via isolation transformer (minimum 3.6 kVA)
Generator / Battery	12 V battery with 12 Ah (e.g. for interior lighting and cable drum motor) Generator system (e.g. Voltstar) up to 8 kVA (optional)
Connection power	3.6 kVA (optional up to 5 kVA)
Connection equipment	
■ HV connection cable	50 or 80 m
■ Power cord	50 m (incl. suitable isolation transformer and power supply system NAS 16)
■ Earth cable	50 m
■ Reference earth connection cable	10 m
■ External safety device connection cable	15 or 50 m
■ Three-phase LV connection cable (optional)	25 or 50 m

Parameter	Value
Safety	
<ul style="list-style-type: none"> ■ Electrical safety 	according to DIN EN (IEC) 61010-1
<ul style="list-style-type: none"> ■ Safety and protective equipment 	<p>The following conditions are monitored during operation:</p> <ul style="list-style-type: none"> ■ Earth loop monitoring (F-ohm) ■ Monitoring for dangerous potential increases (F-U) ■ Monitoring for rapid voltage rises ■ Rear door switch ■ Safety key switch ■ Emergency off switch internal/external (EN 50191)
<ul style="list-style-type: none"> ■ Discharge 	Safe discharge even in the event of an emergency shutdown or power failure by the discharge equipment of the respective individual device.
<ul style="list-style-type: none"> ■ Supply voltage 	Overvoltage protection, undervoltage protection, residual current circuit breaker
Wireless data communication via optional 4G/GPS router (<u>only available for CU 15.6 FLPD control unit</u>)	Mobile data (GPRS/EDGE/3G/4G), Wi-Fi, GPS
Operating temperature	-10 °C ... +50 °C
Storage temperature	-20 °C ... +70 °C
Operating humidity	93% at 30 °C (non-condensing)

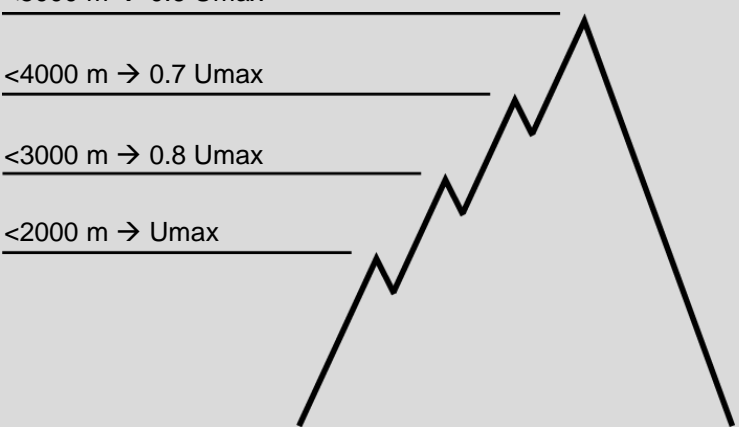
Parameter	Value
Operating altitude	<p>Depending on the operating altitude, the following limit values must be considered when setting the voltage:</p> <p><5000 m → 0.6 U_{max}</p> <p><4000 m → 0.7 U_{max}</p> <p><3000 m → 0.8 U_{max}</p> <p><2000 m → U_{max}</p>  <p>U_{max} refers to the maximum voltage of the respective voltage source.</p>

Technical data of the available control units

Parameter	CU 10.1 FL	CU 15.6 FL	CU 15.6 FLPD
Processor	NXP i.MX6Q QuadCore 996MHz	NXP i.MX6Q QuadCore 996MHz	Intel®Core i5-7300U
RAM	1 GB DDR3	1 GB DDR3	8 GB DDR4
Memory	4 GB NAND Flash	4 GB NAND Flash	256 GB SSD
Display	10.1 inch 1280 x 800 WXGA	15.6 inch 1920 x 1080 Full HD	15.6 inch 1920 x 1080 Full HD
Design	Integrated or remote	Remote	Remote
USB	USB 2.0	USB 2.0	USB 3.0
Operating system	Linux®	Linux®	Linux®
Suitable for PD diagnostics?	No	No	Yes

Technical data of the STX 40 fault location system

Parameter	Value
Insulation test	
■ Measurement voltage	1 ... 20 kV
■ Measuring range	100 Ω ... 650 MΩ
DC voltage test	
■ Test voltage	1 ... 40 kV ±1.5 % (adjustable in 0.1 kV increments)
■ Leakage current measurement	0 ... 1 A ±2 %
TDR module (time range reflectometer)	
■ Distance range (at v/2 = 80 m/μs)	20 m ... 320 km (standard) 20 m ... 1280 km („TDR Unleashed“)
■ Pulse width	20 ns ... 10 μs (standard) 20 ns ... 30 μs („TDR Unleashed“)
■ Pulse amplitude	100 V (standard) 250 V („TDR Unleashed“)
■ Resolution	0.1 m at v/2 = 80 m/μs,
■ Accuracy	0.1%
■ Timebase accuracy	<50 ppm
■ Data rate	533 MHz
■ Runtime setting	As v/2 or NVP value 10 ... 149.9 m/μs or 33 ... 492 ft/μs
■ Dynamic range	115 dB
■ Output impedance	50 Ω
■ Distance dependant de-attenuation (ProRange)	+40 dB, adjustable

Parameter	Value
Surging	
■ Surge levels ¹	0 ... 8/16/32 kV with 2000 J 0 ... 4 kV with 1100 J (optional)
■ Surge sequence	Every 3 seconds at 32 kV Adjustable between 3 ... 10 seconds or single surge
Prelocating methods	
■ ARM Multishot	Reflectance measurement in an arc caused by a fault; 32 consecutive error patterns per measurement
■ ICE	Current decoupling from a travelling wave caused by a fault
■ DECAY	Voltage decoupling from a travelling wave caused by a fault
Burning with internal high voltage source	Max. 850 mA in the 5 kV range Max. 400 mA in the 10 kV range Max. 200 mA in the 20 kV range Max. 100 mA in the 40 kV range
Burning with 15 kV burn unit	See the enclosed operating manual
Sheath test	
■ Output voltage	5 ... 20 kV ± 1.5 %
■ Leakage current measurement	0 ... 1 A ± 2 %
Sheath fault pinpointing	
■ Output voltage	5 ... 20 kV ± 1.5 %
■ Timing	0.5:1, 1:3, 1:4, 1:6

¹ If the system is supplied with 120 V AC input voltage, the output power is limited to 1,600 W (in accordance with ANSI/NEMA 5)

Technical data of the FLG 250 audio frequency generator (optional)

Parameter	Value
Frequencies	0.491 kHz, 0.982 kHz, 8.440 kHz (customer-specific frequencies are possible)
Output power	250 W

Technical data of the TDM 45/TDM 4540 test and diagnostic module (optional)

Parameter	Value
Output voltage	
■ Sinusoidal	2 ... 32 kV _{RMS} /45 kV _{peak}
■ Rectangular	±2 ... ±45 kV
■ Cosine rectangular (TDM 4540 only)	±3 ... ±40 kV
■ DAC (damped AC) (TDM 4540 only)	±3 ... ±40 kV
Max. output current source	12 mA _{RMS} (at rated voltage)
Leakage current measurement	(Rectangular, VLF-CR and DC operation)
■ Display range	0 ... 20 mA
■ Resolution	10 µA

Parameter	Value
Frequency	
■ Sinusoidal/rectangular voltage	0.01 Hz ... 0.1 Hz
■ Cosine rectangular voltage (TDM 4540 only)	0.1 Hz
■ DAC voltage (TDM 4540 only)	20 Hz ... 500 Hz
Testable load capacity	(See also the following diagrams)
■ Sinusoidal voltage	0.6 µF at 45 kV/0.1 Hz
■ Rectangular voltage	0.6 µF at 45 kV/0.1 Hz
■ Cosine rectangular voltage/DAC voltage (TDM 4540 only)	4.8 µF at 40 kV
■ Maximum load capacity	10 µF at reduced voltages and frequencies
Tan delta measurement (optional)	
■ Measuring range	10^{-3} ... 10^0
■ Accuracy (at a load capacity >20 nF)	1×10^{-3} or 1 %
■ Resolution	1×10^{-4}

The following graph **applies to tests with sinusoidal voltage** and illustrates the dependence of the test frequency on the capacity of the connected load and the set test voltage. If a test frequency cannot be applied due to the capacity limits specified here, an automatic adjustment is made and the user is informed about this condition.

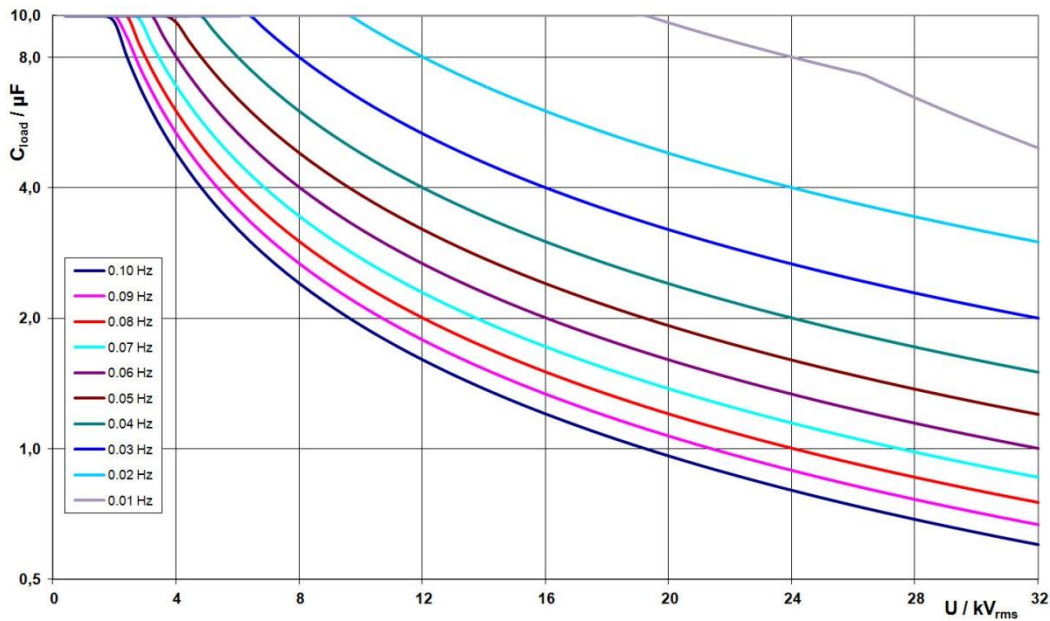

In **cosine rectangular or DAC mode** (TDM 4540 only), the following load graph also applies²:

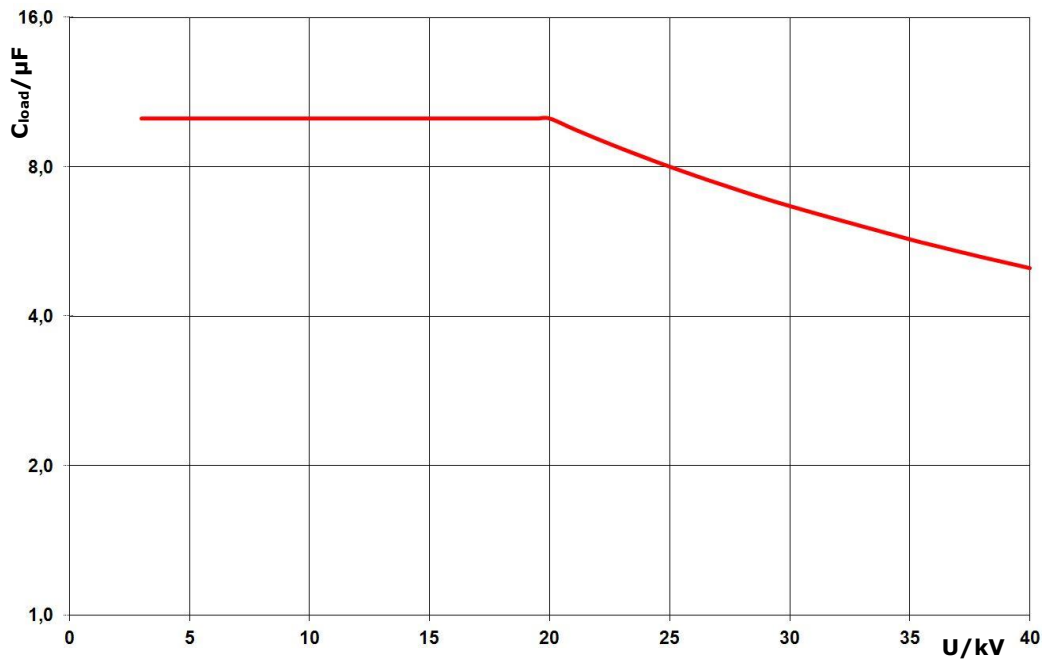

² Only valid between -25 and 45 °C. In the temperature range from 45 °C to 55°C, the power is reduced to 80 % at 40 kV.

Technical data of the TDM 62/TDM 6260 test and diagnostic module (optional)

Parameter	Value
Output voltage	
■ Sinusoidal	2 ... 44 kV _{RMS} /62 kV _{peak}
■ Rectangular	±2 ... ±62 kV
■ Cosine rectangular (TDM 6260 only)	±3 ... ±60 kV
■ DAC (damped AC) (TDM 6260 only)	±3 ... ±60 kV
Max. output current source	23 mA _{RMS} (at rated voltage)
Leakage current measurement	(Rectangular, VLF-CR and DC operation)
■ Display range	0 ... 20 mA
■ Resolution	10 µA
Frequency	
■ Sinusoidal/rectangular voltage	0.01 Hz ... 0.1 Hz
■ Cosine rectangular voltage (TDM 6260 only)	0.1 Hz
■ DAC voltage (TDM 6260 only)	20 Hz ... 500 Hz
Testable load capacity	(See also the following diagrams)
■ Sinusoidal voltage	1.0 µF at 62 kV/0.1 Hz
■ Rectangular voltage	1.0 µF at 62 kV/0.1 Hz
■ Cosine rectangular voltage (TDM 6260 only)	4.4 µF at 60 kV
■ DAC voltage (TDM 6260 only)	4.6 µF at 60 kV
■ Maximum load capacity	10 µF at reduced voltages and frequencies

Parameter	Value
Tan delta measurement (optional)	
■ Measuring range	$10^{-4} \dots 10^0$
■ Accuracy (at a load capacity >20 nF)	1×10^{-4}
■ Resolution	1×10^{-5}

The following graph **applies to tests with sinusoidal voltage** and illustrates the dependence of the test frequency on the capacity of the connected load and the set test voltage. If a test frequency cannot be applied due to the capacity limits specified here, an automatic adjustment is made and the user is informed about this condition.

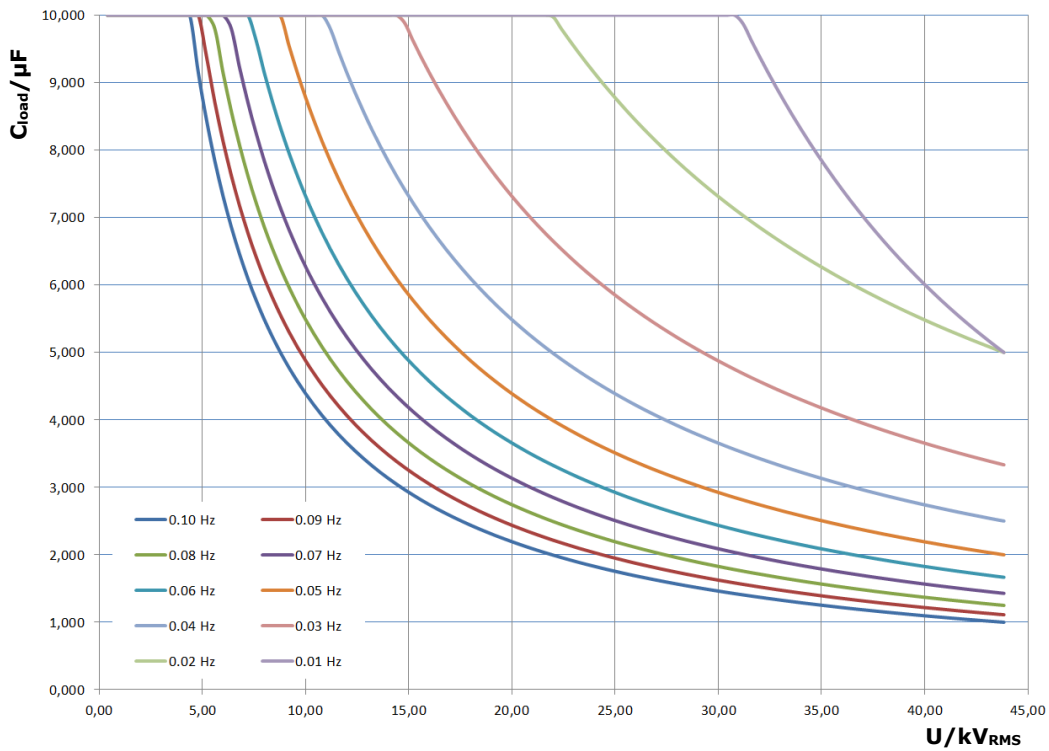

In **cosine rectangular or DAC mode** (TDM 6260 only), the following load graph also applies³:

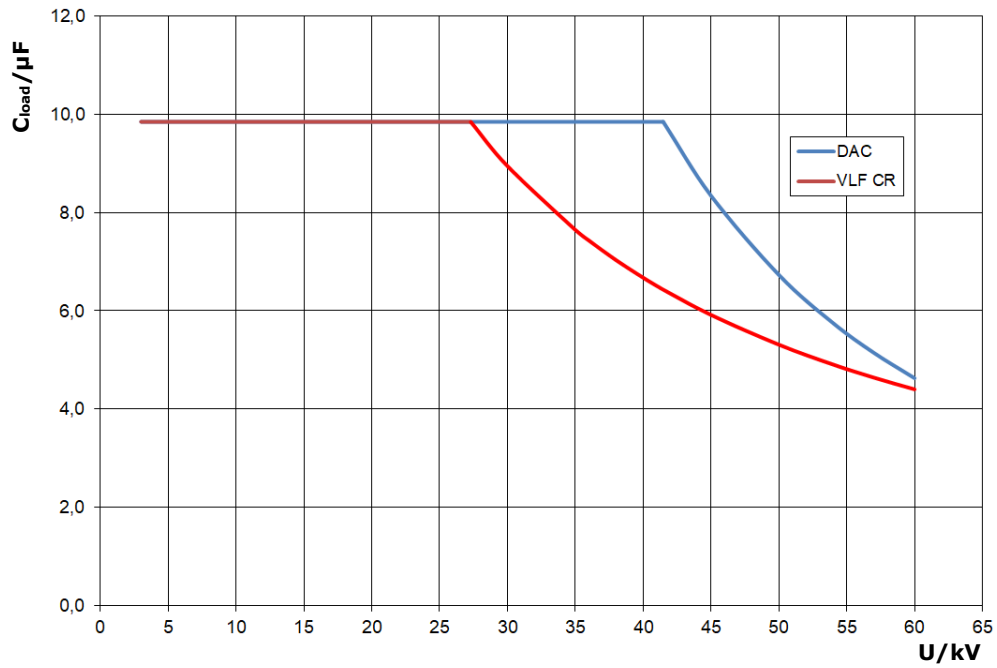

³ Only valid between -25 and 45 °C. In the temperature range from 45 °C to 55°C, the power is reduced to 80 % at 40 kV.

Monitoring devices



WARNING

Risk of electric shock

Safety devices must not be bridged or neutralised!

Proper functioning of the protective devices described below requires that all earth connections (earth cable, F-U cable and cable shield of the connection cable) have been connected to the respective earthing points in accordance with the instructions in this manual.

In high-voltage operation, the following conditions and measured values are continuously monitored by the integrated protective devices (F-ohm, F-U, door contact switch) to ensure a sufficiently good earthing and to protect against hazardous voltages:

- The voltage difference between the test van and the surrounding earth (reference earth) must not exceed 33 V AC or 40 V DC
- The measured voltage-time area must not exceed 50 V/20 ms
- The transfer resistance between the earth spike and the station earth must not exceed 150 k Ω
- The earth loop resistance between the cable shield of the HV connection cable and the protective earth must not exceed 6 Ω
- The rear door must be closed

In the event of a deviation, any high-voltage operation is immediately automatically interrupted and the measuring circuit is discharged. It is only possible to switch on the high voltage again after the rear door has been closed or the earthing conditions have been improved and the measured values are within the tolerance levels.

Emergency shutdown

In the event that an immediate emergency shutdown is required in measuring mode, one of the available emergency off switches must be activated.

These are located on the control unit (see page 43), on the external safety device (see page 40) and optionally at other quickly accessible positions in the vehicle.

In the event of a deviation, any high-voltage operation is immediately automatically interrupted and the measuring circuit is discharged. In addition, the power supply to the measuring system is interrupted. However, the outlets in the control area are still live.

Safety key switches

For reasons of liability, it must be ensured that measuring systems that emit a hazardous voltage can be secured against unauthorised access. This is made possible by the safety key switches on the remote control unit (see page 43) and the external safety device (see page 40).

4 Setting up and connecting the test van

The guidelines for implementation of occupational safety when operating a test system / test van often differ between one network operator and another and it is not uncommon for national regulations (like, i.e. the German BGI 5191) to be used as well. Inform yourself of the guidelines applicable in the area of operation beforehand, and comply with the specified rules for work organization and for implementing the test system / test van.

4.1 Setting up and securing the test van



WARNING

Risk of electric shock

- The test van must never be placed directly over the route of the cable to be tested!
- To ensure that the integrated gravity switches function correctly, the test van must never be operated on inclines that exceed 10%.
- The test van must not show any visible damage, e.g. accident damage, as long as this has not yet been classified as harmless by a Megger service center!
- If the height at the job site exceeds 2000 m, the maximum voltage limit values defined in the technical data must be complied with due to the reduced dielectric strength of the air gaps.
- In the event of large differences in temperature between the storage and installation locations (cold to warm) condensation may form on components carrying high voltage (condensation effect). To avoid any risk of damage to people and devices caused by voltage flash-overs, the system must not be operated when in this condition. It should rather be left in the new environment to acclimatise for approximately one hour before putting it into operation.

The following steps must be carried out to adequately secure the test van and the surrounding area:

1. Place the test van on level ground (inclination <math><10\%</math>) and close to the access to the test object, taking into account its load and external dimensions. Check that the test van is in a stable position.
2. Secure the test van against rolling away by applying the handbrake and positioning chocks against the wheels if necessary.
3. Secure the site in accordance with local regulations using barriers, warning signs and cable bridges.

4.2 Electrical connection

The following figure shows the simplified connection diagram:

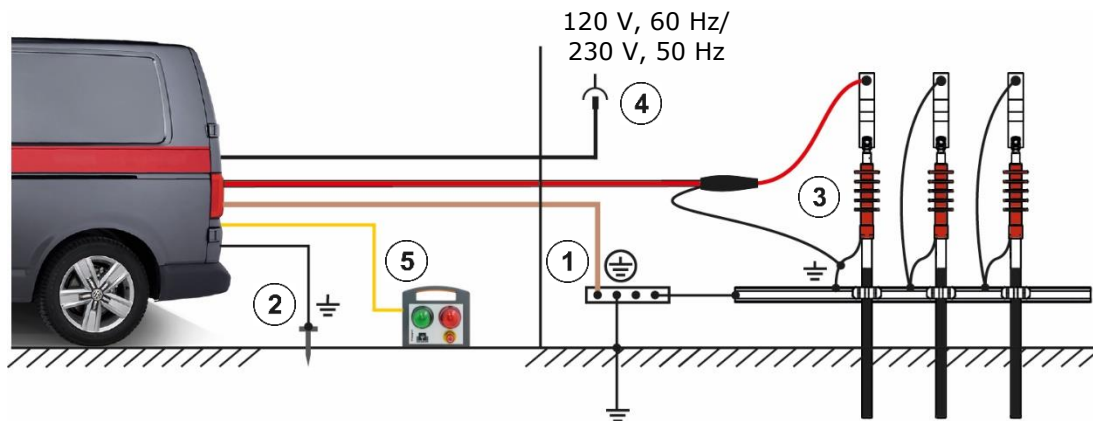

WARNING

Risk of electric shock

The electrical connection must be carried out in the sequence shown in the image. The ground cable must be connected first and the mains connection is made last!

For disconnection, follow the sequence in reverse order.

Follow the specified connection sequence:

- ① Connection of the earth cable (see page 29)
- ② Connection of the F-U monitoring (reference earth) (see page 30)
- ③ Connection to the test object (see page 31)
- ④ Mains connection (see page 38)
- ⑤ Connection of the external safety device (see page 40)

4.2.1 Connection equipment



The arrangement and equipment of the connection system may differ depending on the vehicle type and equipment variant.

Example configuration

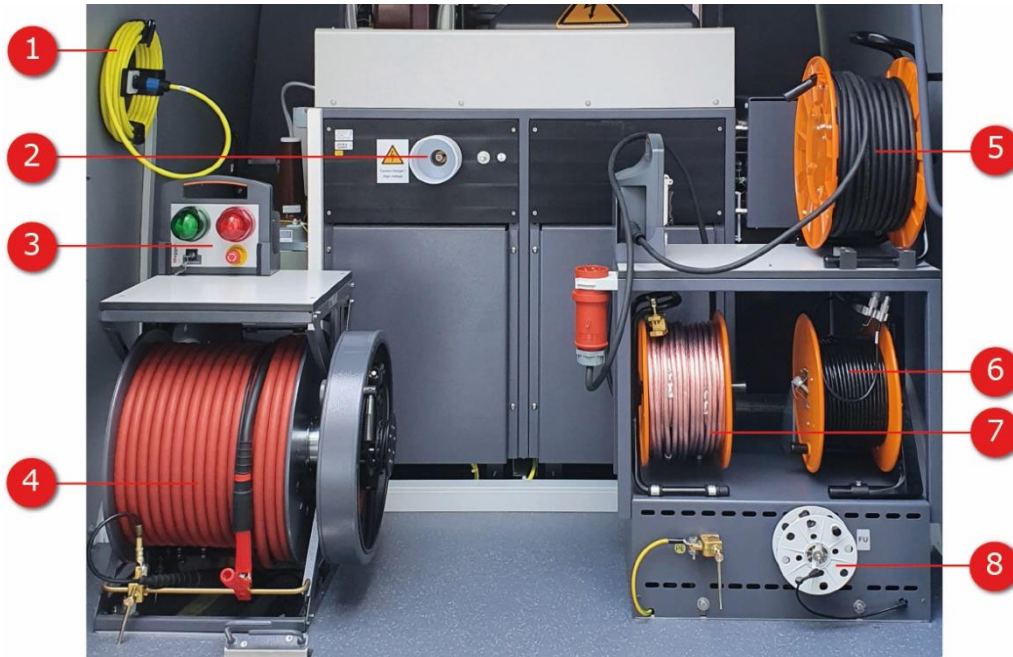

Number	Description
1	Cable for connecting the external safety devices (depending on length, can also be on a drum)
2	HV output of the system. Systems with Test and Diagnostics Module (TDM) have an additional HV output and are accordingly equipped with a remote connection panel.
3	External safety device (see page 40)
4	HV connection cable
5	Power cord
6	Three-phase LV connection cable (optional)
7	Earth cable
8	Reference earth cable (F-U monitoring)

4.2.2 Connection of the earth cable



WARNING

Risk of electric shock

- The test van must never be operated without a connected earth cable. The earth cable provides the connection between the system and the protective earth and ensures that the entire system is safe to touch.
- The test van may only be connected to earth systems or single earth conductors with transition resistors $<2 \Omega$.
- Protective earth (earth cable) and system earth (shield of the HV cable) must be connected in such a way that no impermissible voltage difference can arise between protective earth (PE) and neutral conductor (N).
- For TT networks, there is no connection between the neutral conductor (N) and protective earth (PE) in the station. A suitable cable must be used to establish the connection for the measurement.

To connect the earth cable, proceed as follows:

1. Release the brake on the earth cable drum.
2. Unwind the cable as far as necessary and connect it to the station earth or another suitable foundation earth.
3. Clamp one of the contact sleeves attached to the cable at 5 metre intervals under the connecting clamp next to the cable drum.

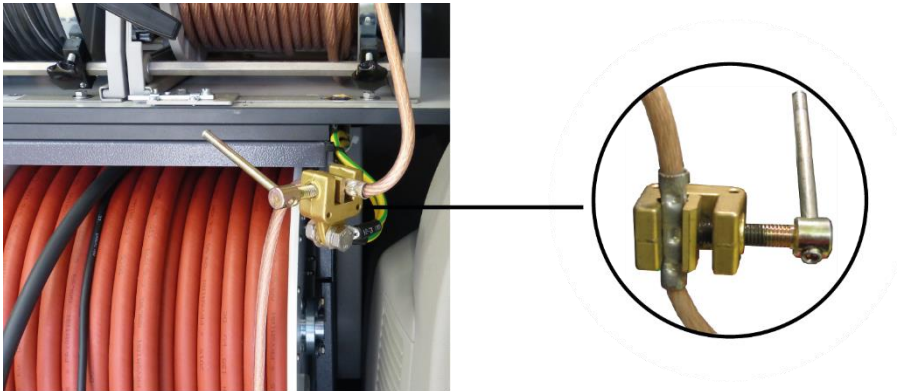

4. Secure the cable drum brake again.

4.2.3 Connecting the reference earth (F-U monitoring)



The direct connection between the measuring system and the surrounding earth (reference earth) is essential for functioning earth monitoring (F-U) and a safe measuring operation (see page 25). Even in heavily built-up areas where it is difficult to insert the earth spike this protective device must not be bridged and neutralised! The following measures can help to establish a sufficiently low-impedance earth connection:

- Try inserting the earth spike in other locations that provide better ground contact. In heavily built-up areas, joints between concrete slabs may be used for example.
- Moisten the place where the earth spike was inserted with water.
- Attach the reference earth to a foundation earth (e.g. a lightning protection system). However, do not use the same foundation earth to which you have already connected the main earth cable.

Proceed as follows to establish the reference earth connection for monitoring the voltage-time area and the fault voltage:

1. Disconnect the system's connection cable from the F-U cable drum.

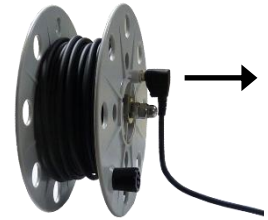

2. Place the supplied earth spike into the ground in the immediate vicinity of the test van and attach the end of the F-U cable to it.



3. Reconnect the system's connection cable to the F-U cable drum.

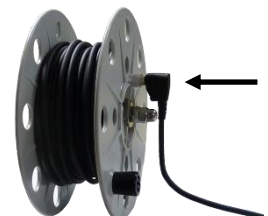

4.2.4 Connection to the test object



WARNING

Risk of electric shock

- Before connection to the test object, the five safety rules (see page 7) must be applied.
- All phases of the test object which are not being tested must always be short-circuited and earthed.
- Protective devices (guard rails, chains, bars etc.) must be installed on the test object as a barrier to prevent contact with active parts and to ensure that the danger zone cannot be accessed.
- Since the voltage applied to the test object can assume hazardous values, all cable ends must be isolated to prevent contact. It must be ensured that all branching points are considered.

4.2.4.1 Using the HV connection cable

Instructions for operating the cable drum



CAUTION

Before using the motor drive, always connect the earth cable of the test van to protective earth first.





CAUTION

Risk of crushing

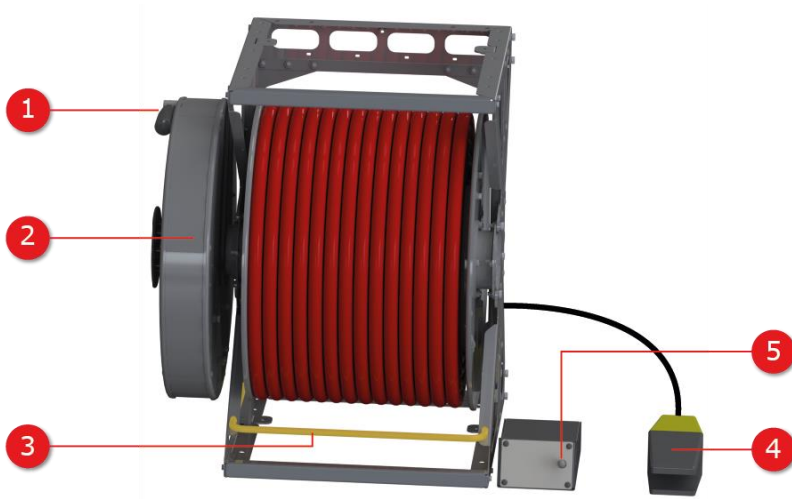
To prevent fingers and hands becoming crushed during the motorised winding of the HV connection cable, the wearing of suitable protective gloves and careful handling is recommended.



Number	Description	
1	Hand crank to manually wind and unwind the drum (only available with manual version)	
2		<p>Storage space for the system-side end of the HV connection cable.</p> <p>The cable end must always be properly stowed in the drum body before the HV connection cable can be unwound or wound.</p>
3	Earth rail for short circuit and earthing of the cable ends when the HV connection cable is not in use.	
4	Foot pedal for motor-assisted winding of the drum (only available on motorised version). The drum is manually unwound by pulling the cable.	
5		<p>Circuit breaker (only available on motorised version) that trips when the drum motor is overloaded and disconnects the control unit from the power supply.</p> <p>After tripping, ensure that the cable runs freely and push the circuit breaker back in. Then continue the drum operation.</p>

Basic procedure

The electrical connection between the HV connection panel and the test object is established as follows:

1. Ensure that the system-side end of the HV connection cable, which protrudes from the side of the cable drum, is not connected to the HV connection panel and is properly stowed in the drum body.
2. Release the brake on the cable drum.
3. Manually unwind the HV connection cable as far as necessary.
4. Connect the HV connection cable to the test object using suitable terminals. When doing so, observe the notes and sketches on the following pages.



If the connection to the test object is made using additional measuring accessories (e.g. a partial discharge measuring system), the instructions for connecting the devices can be found in the respective operating instructions.

5. Connect the system-side end of the HV cable to the HV connection panel. When doing so, observe the notes and sketches on the following pages.
6. Secure the cable drum brake again.

Typical connection scenarios



If your system is a tailored solution with an individual connection panel and/or different connection accessories, please refer to the signs on the inside of the rear door for the details of the electrical connection to the test object.

Depending on the equipment of the test van and the desired operating mode, the connection between the HV connection panel and the test object must be made as follows:

Fault location, DC test

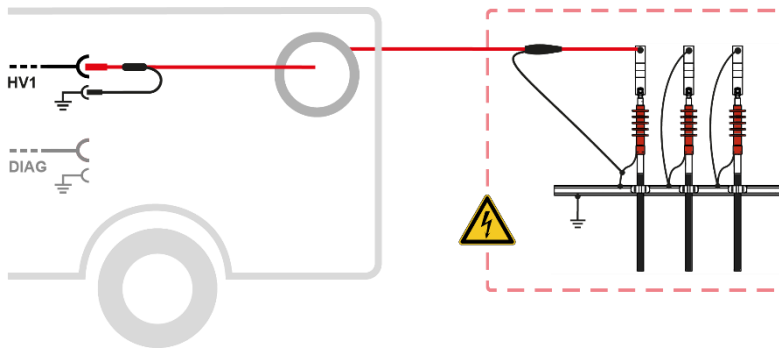

Sheath test and sheath fault location

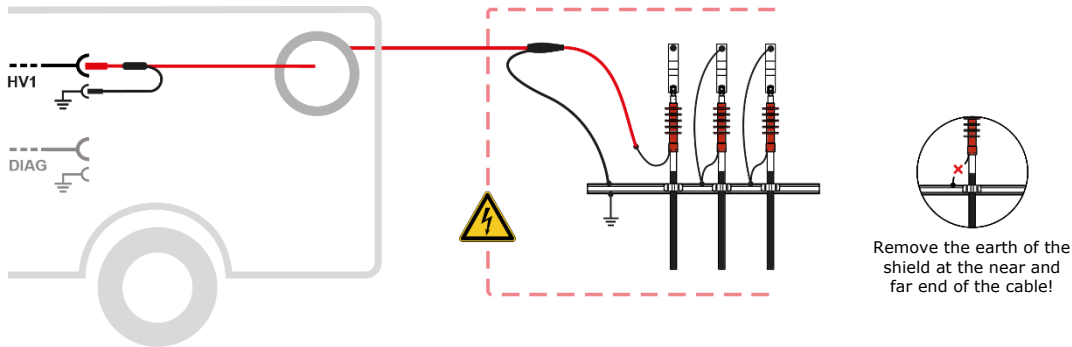

VLF tests using TDM

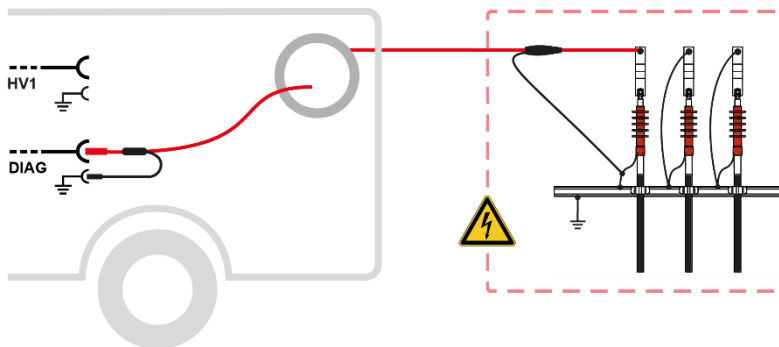

PD diagnostics with external partial discharge coupler PDS 60(-HP)

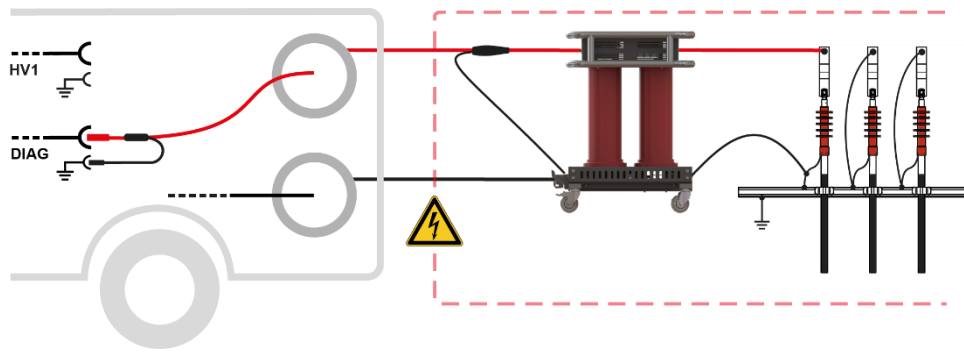

PD diagnostics with external partial discharge coupler PDS 62-SIN

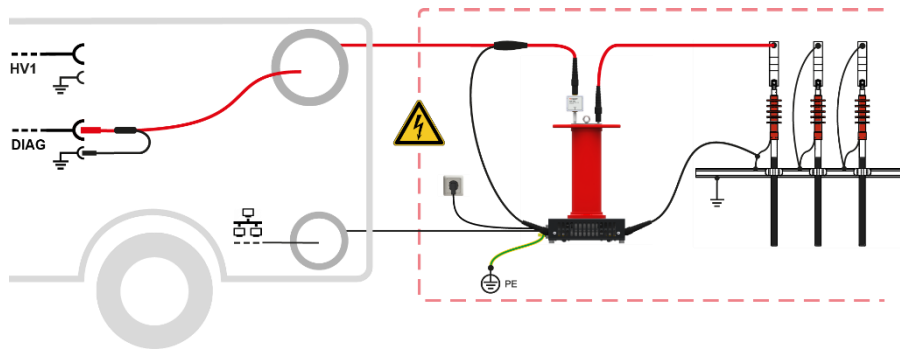

PD diagnostics with internal partial discharge coupler PDS 60(-HP)

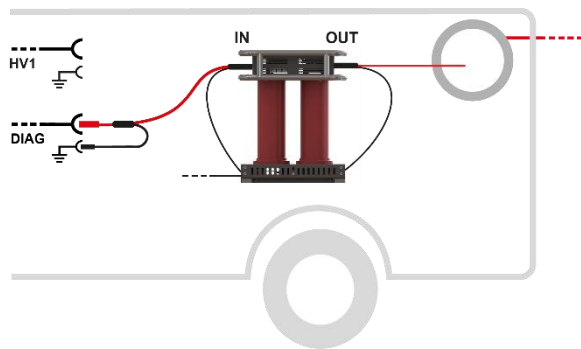

TanDelta measurement (step test or MWT)



The cable shield on the HV connection cable must be connected to the shield of the test object using the HVCC adapter supplied. A system-side connection of the adapter to the connection panel is not permitted!

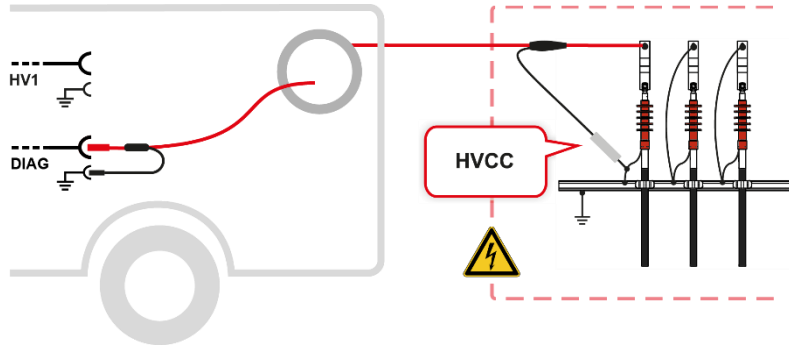

4.2.4.2 Using the three-phase LV connection cable (optional)

As an alternative to the HV connection cable, the optional LV coaxial cable can also be used for a TDR measurement, which enables a three-phase measurement.

To connect the LV cable to the test object, proceed as follows:

1. If the connection cable coming from the system is connected to the socket of the cable drum body, this connection must be disconnected before the cable can be unwound.



2. Unwind the LV cable.
3. Connect the pre-assembled four-wire adapter cable intended for the test object connection to the unwound LV cable.



When connecting, make sure that the four wires run as uniformly as possible to each other (ideally twisted) and that they are not separated from each other until just before the actual connection point. This ensures the same impedance ratios for all three phases.

The identification of the phases must be considered during connection to be able to correctly assign the measurement results to the respective phases.

4. Using suitable connection accessories, connect the individual phases of the LV cable to the phases of the test object and the operating earth (red terminal) to the earthed shield of the test object.
5. Reconnect the connection cable coming from the system to the socket on the cable drum.



4.2.5 Establishing the mains supply

4.2.5.1 Connection to mains supply



WARNING

Risk of electric shock

If the object to be measured and the mains power supply are connected to different earth systems that are not interconnected, the potential equalisation must be established using a connection cable with a cross-section of at least 16 mm² Cu while the test van is in operation. Good earthing conditions are of utmost importance here!

Proceed as follows to connect the test van to a mains power supply:

1. Release the brake on the mains cable drum.
2. Release the anti-roll latch on the outside of the cable drum housing by pulling the metal bar outward.

To lock the anti-roll latch before winding the drum back up, press on the round screw head.



3. Unwind the mains supply cable.



CAUTION

The mains cable drum must always be completely unrolled!

4. Connect the cable to a mains power outlet.



CAUTION

Only approved (VDE/IEC or corresponding national regulations) intermediate connections are to be used for the connection to mains sockets that do not fit the pre-assembled plug or for direct connection to the low-voltage cable!

Result: The two signal lamps **IN** and **OUT** on the mains connection system NAS 16 should now light up, indicating that the input voltage is within the permissible range. If this is not the case, check the mains supply and the fuses in the NAS 16 (see page 56).



5. Secure the cable drum brake again.

4.2.5.2 Operation via generator or battery power supply (optional)

If there is no possibility to tap mains power in the immediate vicinity of the deployment location, the measuring system can also be operated via an adequately dimensioned generator system or battery voltage supply.

An integrated battery power supply provided by Megger automatically takes over the supply of the measuring system if the test van has not been connected to mains voltage.

The generator systems provided by Megger are typically vehicle engine driven systems, which must be commissioned manually if necessary. To do this, the vehicle must be put into neutral, the generator switched on and, if necessary, the engine speed must be regulated. The exact procedure differs depending on the generator and vehicle model.

When the generator is in operation, the system automatically draws its operating voltage from the generator. This also applies if the test van is connected to the mains power supply.



For detailed information on the handling, specification and safety of the systems provided, refer to the manufacturer's product information.

4.2.6 Connection of the external safety device

The external safety device can be used to signal the status of the system outside the test van and to interrupt or disable the HV preparation via the emergency off switch and key switch.

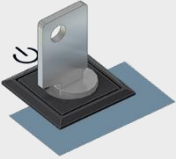
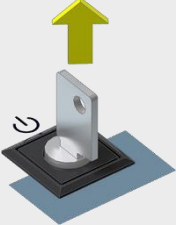

Number	Description
1	<p>Signal lamps for the widely visible signalling of the switching state according to EN 50191.</p> <p>If the green light is active, the system has been powered on but has not yet been put into high voltage operation.</p> <p>The red light comes on as soon as high voltage can be generated. All discharge and earth devices are open and the test object is to be considered "live".</p>
2	Emergency off switch (see page 25)
3	<p>Safety key switch for locking the high-voltage preparation.</p> <div style="display: flex; align-items: flex-start;"> <div style="flex: 1;">  </div> <div style="flex: 2;"> <p>The key switch is unlocked and high-voltage preparation is possible, provided that all other safety conditions are also met.</p> </div> </div> <div style="display: flex; align-items: flex-start; margin-top: 10px;"> <div style="flex: 1;">  </div> <div style="flex: 2;"> <p>The key switch is locked and high-voltage preparation is not possible. When locked, the key can be removed and the system secured against unauthorised high-voltage operation.</p> </div> </div>

The external safety device must be placed in an accessible and clearly visible position in the vicinity of the test van and connected to the designated socket of the connection box via the connection cable provided.

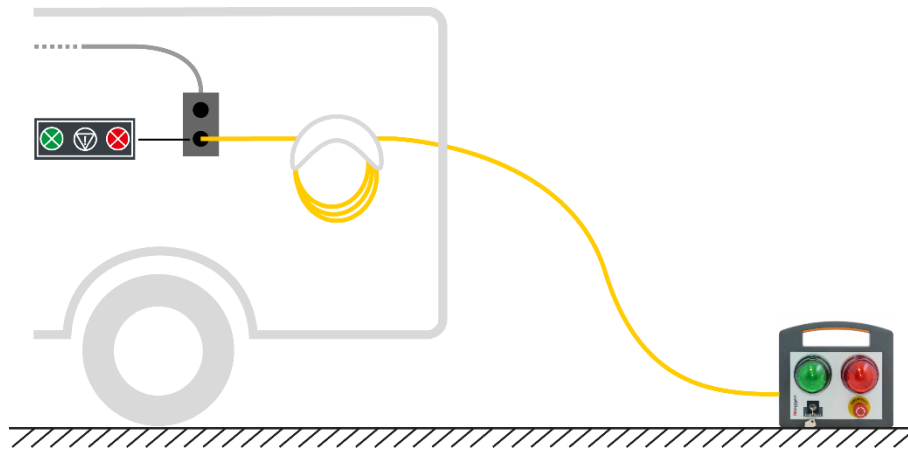

For systems with a cable drum, the connection cable from the system side must be disconnected from the cable drum for the unwinding and rewinding process.



4.3 Switching on the test van

After the test van has been connected or a change has been made to the test object connection, the connection cables should be pulled out of the vehicle in such a way that the rear door can be closed without squeezing or kinking the cables. Most test vans are equipped with a cable guide and a movable door flap for this purpose.

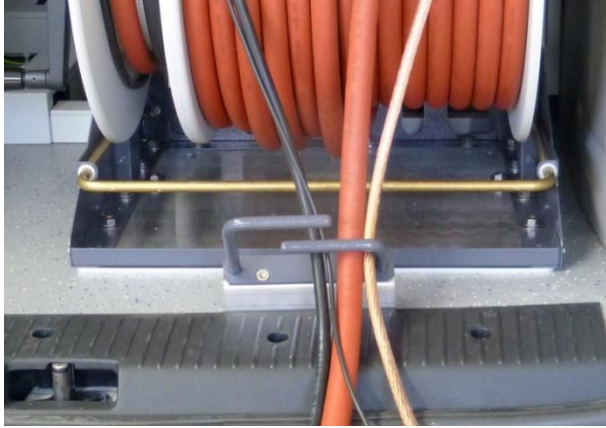

After the rear doors of the test van have been closed, it is ready to be switched on. Provided that the connection has been correctly implemented and good earthing conditions have been observed, the conditions of the safety circuit are also fulfilled.

5 Operation of the test van

5.1 Operating unit

Depending on the space available in the vehicle and the performance requirements of the installed software, different control units are used.

Especially when installed in very small vehicles or trailers without a separate operating area, the measuring system can be operated directly via the integrated control unit of the STX 40. It has a 10.1-inch display and is suitable for cable fault detection and VLF testing.



In vehicles that have sufficient space for a spatial separation between the system components and the operator's workplace, a remote control unit is used. It has all the necessary controls and is optionally equipped with a 10.1 inch display (model 10.1 FL) or a 15.6 inch display (model 15.6 FL or 15.6 FLPD). Each version of this remote control unit is suitable for cable fault detection and VLF testing.



A special, more powerful version of the 15.6 inch control unit with x86 processor also enables the execution of partial discharge measurements and the use of the protocol software.



Regardless of the type of control unit used, it offers the following display, operating and connection elements:



Number	Description
1	Touch display
2	Emergency off switch (see page 25)
3	USB 2.0 port for connecting input and output devices and storage media (see page 52) <u>CU 15.6 FLPD control units</u> have two additional USB 3.0 ports on the rear of the housing.
4	On/off button
5	Green 'HV On' button for enabling the high-voltage preparation
6	Red 'HV Off' button for manual shutdown of the high voltage
7	Rotary encoder with tilt function for operating the software
8	Safety key switch (<u>only on remote control unit</u>) When locked, the key can be removed and the system secured against unauthorised high-voltage operation. If operation is carried out directly on the control unit of the STX 40, the safety key switch of the external safety device must be used for this purpose (see page 40).

5.2 Other operating and connecting elements in the control area

Systems that have been installed in a vehicle by Megger itself are equipped with a number of additional control and connection elements, depending on the equipment in the control area:

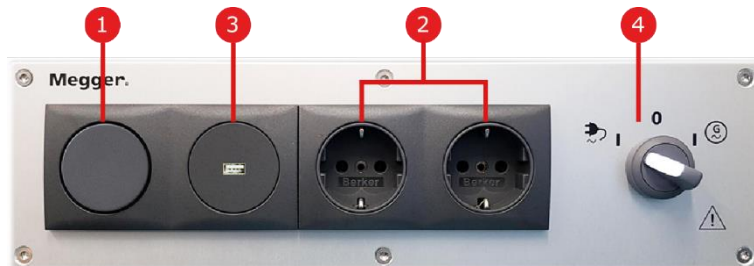

Number	Description
1	Switch for interior lighting.
2	Sockets with an output voltage and design suitable for the region of application. <div style="border: 1px solid black; padding: 5px; margin-top: 10px;">  <p>CAUTION Danger of electric shock Sockets are not de-energized when the emergency off switch is used!</p> </div>
3	USB charging socket (not used for data transmission).
4	Main power switch for switching on/off the mains or generator voltage.

5.3 Switch on





NOTICE

When operating the measuring system in an electric vehicle, charging the vehicle during the measurement is not permitted! Failure to do so may result in damage to the charging unit of the electric vehicle.

After the test van has been set up and connected according to the instructions in the previous chapter, the measuring system can be switched on as follows:

1. Use the main power switch located near the control unit to supply voltage to the measuring system.

Set it to position , if the system is connected to mains voltage. If the system is operated via generator or battery power supply (optional), set the switch to position  instead.

2. Press the illuminated on/off button  on the control unit to switch on the measuring system.

If the button is not lit, this indicates problems with the mains supply (see page 38).

Result: The measuring system starts. When the boot process is complete, the start screen of the operating software appears.

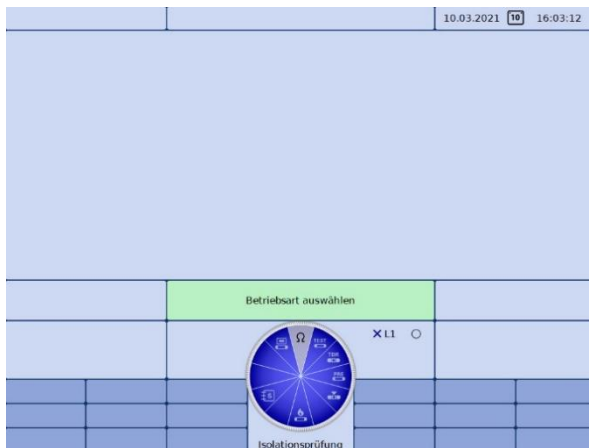



If problems are detected during start-up of the measuring system that would prevent a safe measuring operation, these are signalled in a separate dialogue and must be eliminated (see page 47).

5.4 Resolving signaled problems

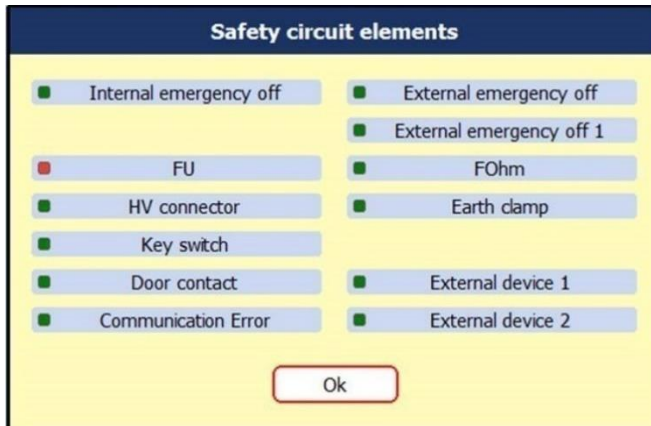
If safety problems are detected during start-up of the measuring system, the following dialogue opens after the boot process has been completed, which signals the status of the individual safety circuit elements:



Before the dialogue can be acknowledged and the actual measuring mode can be started, all signaled problems must first be eliminated. The status of the respective elements can be read by the colour of the status icon:

-  FOhm The conditions of this safety circuit element are met and no action is required.
-  FOhm Deviations from the conditions required for operation were found in this safety circuit element. The problems should be corrected using the information in the table below.
-  FOhm A problem has been signalled for this safety circuit element, but no longer exists. Thanks to this special status, the operator can still identify the element triggering the safety message even if the problem occurred only briefly.

Depending on the problem signaled, the following actions must be taken:

Message	Possible cause/remedy
Internal emergency off	The emergency off switch on the control unit has been actuated and must first be reset.
F-U	<p>The F-U monitoring device (see page 25) has detected a dangerous deviation in the monitored parameters.</p> <p>It must be checked that the following connections have been made correctly and provide good earth contact:</p> <ul style="list-style-type: none"> ■ Earth cable ■ Reference earth connection (e.g. lack of earth contact of the earth spike, connection between cable drum and system not established)
HV connector	The HV power cable connector is not fixed firmly enough into the high voltage output of the STX 40. If necessary, the union nut must be tightened.
Key switch	The safety key switch on the control unit (see page 43) is not in the correct position.
Door contact	The rear door of the measuring vehicle is not closed or not properly closed.
Communication error	<p>An error occurred during communication between the modules within the measuring system.</p> <p>The system should be restarted.</p> <p>If the problem occurs repeatedly, contact an authorised service workshop.</p>
External emergency off	<p>Either the emergency off switch has been pressed or the safety key switch has been locked on the external safety device (see page 40).</p> <p>If this is not the case, check the connection of the external safety device to the system.</p>
External emergency off 1	The emergency off switch (optional) installed inside the vehicle has been actuated and must be reset first.
FOhm	<p>The F-Ohm monitoring device (see page 25) has detected a dangerous deviation in the monitored parameters.</p> <p>It must be checked that the following connections have been made correctly and provide good contact:</p> <ul style="list-style-type: none"> ■ Earth cable ■ Cable shield of the HV connection cable (test object and system-side) ■ Reference earth connection (e.g. lack of earth contact of the earth spike, no connection between cable drum and system)

Message	Possible cause/remedy
Earth clamp	The earth wire is not connected to the earth terminal on the cable drum (see page 29).
External device 1	One of the external auxiliary devices reports a safety problem. If the problem is still signalled after checking the wiring and restarting the measuring system, an authorised service workshop must be informed.
External device 2	One of the external auxiliary devices reports a safety problem. If the problem is still signalled after checking the wiring and restarting the measuring system, an authorised service workshop must be informed.

5.5 Operation

The software can be operated using the touch display, the rotary knob with tilt function or USB mouse. A USB keyboard can also be connected to the CU 15.6 FLPD control unit.



Detailed information on the operation of the software and the measuring procedures as well as on the high-voltage release can be found in the accompanying software manual.

6 Work after completion of the measurement job

Before opening the rear doors of the test van and making adjustments to the electrical connection, the following measures must be taken:

- Press the red 'HV Off' button to switch off the high voltage and initiate the discharge.
- Ensure that there is a short circuit and earthing for the test object at the connection point.



WARNING

Risk of electric shock

- The five safety rules (see page 7) must be applied when disconnecting the connection between the test van and the test object.
- Even if properly switched off and discharged with the discharging device, system components that have been energised should only be touched if they have been discharged with a suitable discharging rod, as well as earthed and short-circuited.
- Do not remove the earthing and short circuit until the test object is to be put back into operation.

When the measurements are complete, follow these steps to turn off the test van and disconnect the electrical connections:

1. Complete the work with the measurement and logging software and ensure that you have either exported or uploaded all the records required for later follow-up to the cloud database.



For detailed information on operating the software, refer to the accompanying software manual.

2. Press the illuminated on/off button  on the control unit to switch off the measuring system.
3. Set the main power switch to position **0** to interrupt the voltage supply to the measuring system. The main power switch is always located near the operator station.

4. Disconnect the electrical connections. To dismantle, use the same method as for connecting (see page 27) but in reverse order.
5. If the test van is equipped with a partial discharge coupler (e.g. PDS 60(-HP)), it must be short-circuited using a short-circuit cable (external coupler) or the HV connection cable connected to the input 'IN' (internal coupler) to avoid charging the integrated capacitor.

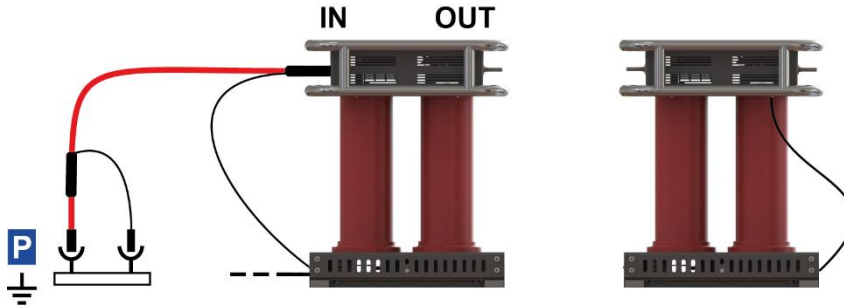

7 IT accessories and connectivity

7.1 Use of USB accessories



CAUTION

Risk of damage due to vibration and interference

To prevent malfunction or even damage to the control unit, observe the following instructions:

- Remove longer USB sticks from the USB port after the work has been completed.
- Do not use extension cables when connecting USB accessories.
- In HV operation, no loose USB connection cables may be inserted into the USB ports of the control unit.

Depending on the model, the control unit (see page 43) has at least one USB port to which the following accessories can be connected:

Class	Description
Input devices	<p>A USB mouse can be connected to all available control units and allows full operation of the software by mouse.</p> <p><u>Operating units of the type CU 15.6 FLPD</u> additionally allow the connection of a USB keyboard for convenient data input.</p> <p>It is also possible to connect a wireless keyboard and/or mouse with a suitable USB dongle.</p>
USB mass storage	<p>USB mass storage devices (such as USB sticks and external hard disks) can be connected for importing and exporting measurement data and reports.</p> <p><u>CU 15.6 FLPD control units</u> have two additional USB 3.0 ports on the rear of the housing for fast transfer of larger amounts of data.</p>
Printer	<p>A printer can be connected to the USB port on <u>CU 15.6 FLPD control units</u> for direct printing of measurement data and reports. However, the selection of compatible printers is limited by the drivers installed on the system.</p> <p>Before purchasing a printer, please contact your Megger sales representative for a list of supported devices.</p>

7.2 Internet and GPS connectivity (optional)

Requirements

To connect to the internet and receive GPS signals, the system must be equipped with the optional 4G/GPS router and the CU 15.6 FLPD control units. In most cases, the router is located on the vehicle's partition or side walls and is easily accessible. With the exception of the software configuration of the router and the replacement of the SIM card, no unauthorised adjustments may be made to the router and its wiring.

Purpose

Internet and GPS connectivity are required for the availability of the following software features:

- Access to online maps
- Remote control of important location and line location methods via app
- TeamViewer remote access for support and demonstration purposes
- Location indicator in the map view

Inserting/swapping the SIM card

To establish a mobile data connection, there must be at least one SIM card in the router. There may also be a second slot for inserting a second SIM card available. The SIM cards must meet the following requirements:

- Format: Mini SIM
- Enabled for internet use using GPRS, EDGE, 3G or 4G (a data-only plan is sufficient)
- Providers with good network coverage



It is recommended that contracts be concluded with a fixed upper cost limit to always keep control of the costs incurred, even in the case of high data consumption!

To replace the currently installed SIM card or insert a SIM card for the first time, proceed as follows:



After the new SIM card is inserted in the orientation shown, the holder must be pushed back into the slot until it clicks into place. Following the installation of a new SIM card, the PIN of the SIM card must be stored and the configuration of the access point (APN) adjusted.



For detailed information on the software configuration of the router and the data connection, refer to the accompanying software manual or the online help of the software.

If there is a SIM card in both slots **SIM1** and **SIM2**, the data connection of the SIM card in slot **SIM1** is used until one of the following conditions occurs:

- The data volume of the SIM card in slot **SIM1** is used up.
- A data connection via the network provider of the SIM card in slot **SIM1** cannot be established.

Troubleshooting connection problems

If you experience connection problems while using the test van, the LEDs on the router may help you determine the cause of the problems. The following states are signalled:

LED	Status	Description
PWR	Off	No mains voltage available
	On	Mains voltage available
2G 3G 4G	Off	No connection could be established to the respective network.
	All LEDs are flashing at the same rate	No SIM card found or there are problems with the SIM cards. This may be due to the access point (APN) or SIM PIN not having been configured yet or not having been configured correctly.
	Permanently lit or flashing a single colour	A connection to the respective network exists. When there is data traffic, the LED flashes very quickly.
		Signal strength
SIM1 SIM2	Off	No data connection could be established via the SIM card.
	On	There is an active data connection via this SIM card.

8 Troubleshooting

8.1 Behaviour in the event of faults during normal operation

8.1.1 Check fuses

If a fault occurs, the various circuit breakers and fuses of the measuring system should be checked first.



Note

Risk of damage to the measuring devices

If a circuit breaker or a fuse is repeatedly triggered, it must be assumed that there is a permanent fault in the affected circuit. In order to avoid consequential damage, further operation of the measuring system is not permitted.

Fuses of the measuring system:

In case of problems with the mains supply, the fuses of the measuring system should be checked first. Depending on the type of installation, the fuse panel is either located in the operating room or near the connection equipment.

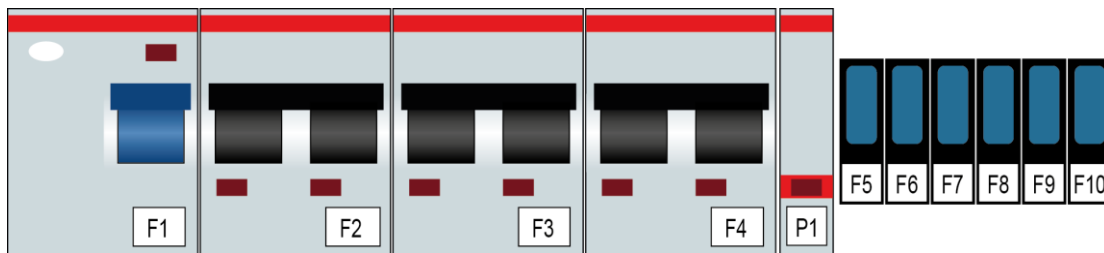

Number	Value	Function
F1	F202A-40/0.03	FI circuit breaker
F2	C16	Electrical outlets
F3	C16	Electrical outlets/air conditioning (optional)
F4	C25	Supplied large unit (optional)
P1	LED	Signalling in case of overload of the internal generator (optional)
F5 / F6	4A	Mains switch
F7 / F8	4A	Generator switch
F9	6A	12 V distribution
F10	6A	24 V distribution

Fuses in the mains supply system:

Especially in the case of power supply problems, the fuses in the power supply system (NAS 16) should also be checked. This is located at the end of the mains cable.

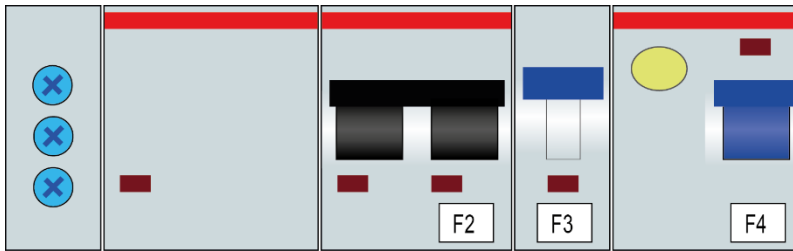

Number	Value	Function
F2	K16A	Main fuse power supply
F3	C2	Voltage monitoring Overvoltage protection
F4	RCD K16 / 0,3 A	Test van main circuit
F5/F6 ⁴	T1A	Indicator lights on the NAS

Fuse on the 12 V battery:

In case of problems with the interior lighting and the cable drum motor, the 20 A flat plug fuse on the 12 V battery should be checked. In most cases, the battery is located in the rear part of the vehicle behind the connection equipment.



Type	Value	Function
Flat plug fuse	20A	Interior lighting and cable drum motor

⁴ Inside the housing

8.1.2 Other possible fault causes

If problems occur, they may be diagnosed and corrected using the following table:

Problem	Possible cause/remedy
<p>VLF test not possible</p> <p>When a VLF test is started, it indicates that the connected cable cannot be charged.</p>	<p>It must be checked whether all voltage converters have been disconnected from the test object.</p> <p>It is possible that a fault in the test object may also be the cause of this problem.</p>
<p>Very high PD interference levels</p> <p>In preparation for a partial discharge measurement, a very high basic interference level (>500 pC) is measured.</p>	<p>It must be checked that all earth connections are clean, have no corrosion and provide good metallic contact.</p> <p>If these measures do not achieve the desired success, a measurement from the other side is recommended.</p>
<p>Decreasing tan delta measured values</p> <p>During a tan delta measurement, significantly decreasing tan delta measured values are detected as the voltage increases</p>	<p>This may indicate moisture in the cable or at the end caps (especially if humidity >85 %).</p> <p>It is recommended to dry the end caps and clean them with a suitable cleaning agent.</p> <p>If these measures do not achieve the desired success due to climatic conditions, the measurement should be repeated when conditions have improved.</p>
<p>High PD level at the beginning of the cable</p> <p>During a partial discharge measurement, noticeably high partial discharges are measured directly at the start of the test object</p>	<p>These partial discharges could be caused by an improper type of connection.</p> <p>It is recommended to maximise the distance from earthed parts. The use of insulating mats must be avoided.</p> <p>In particular, in the case of partial discharge measurements with VLF sinusoidal voltage, corona discharges can also be the reason. This can be counteracted by appropriate field control measures such as corona rings.</p>
<p>Cable drum motor / interior lighting does not work</p>	<p>If the fuse on the 12V battery is intact (see previous section), it can be assumed that the battery is completely discharged.</p> <p>Connect the system to mains power for an extended period of time to recharge the battery.</p> <p>If this does not help, a replacement of the battery has to be arranged with an authorized service workshop.</p>

8.2 Behaviour in the event of continuous faults

In the event of damage, irregularities or malfunctions that cannot be rectified using the information in the operating instructions, the following steps must be carried out immediately:

1. Switch off the measuring system.
2. Insert a USB stick into the USB port of the operating unit.
3. If still possible, turn on the system and import the error memory to the inserted USB stick.



For detailed information on operating the software, refer to the accompanying software manual.

4. Take the measuring system out of operation and mark it accordingly as not functional.
5. Inform a service workshop authorised by Megger of the fault and provide the service personnel with the log file read out.

9 Care and maintenance

9.1 Testing and maintenance measures to be carried out by the operator

In order to identify potential problems at an early stage and to maintain the system in good condition, it is essential that you carry out the following tasks yourself and at appropriate intervals, depending on the usage behaviour:

- Remove dust and dirt
- Check the function of the door and emergency off switches
- Unwind the cables and check for breaks and damage
- Check the connection cables and modules of the high-voltage components for secure hold



Refer to the relevant sections in the respective operating manual for information on maintenance and care of the peripheral devices to be carried out by the operator. This especially applies to battery-powered devices.



If you notice any defects during the test, please promptly inform a service workshop authorised by Megger.

9.2 Required maintenance by a service workshop

A measuring system of the technical complexity of Primeon requires regular maintenance in order to maintain its functionality. Megger recommends that the system be checked and serviced once every two years at a Megger service centre.

In addition, necessary measures such as usage-dependent maintenance of the shock switch are announced by system messages in the software. If such a system message occurs, a maintenance appointment must be arranged with the responsible service workshop immediately!



If the maintenance requirements are not fulfilled, the manufacturer is released from the warranty for defects shown to be due to inadequate maintenance.

Sales contact

Megger Limited
Archcliffe Road
Dover, Kent CT17 9EN
United Kingdom
T. +44 (0) 1304 502101
E. uksales@megger.com
W. uk.megger.com

Production sites

Megger Limited
Archcliffe Road
Dover, Kent CT17 9EN
United Kingdom
T. +44 (0)1 304 502101
E. uksales@megger.com

Megger Germany GmbH
Dr.-Herbert-lann-Str. 6
96148 Baunach
Germany
T. +49 (0) 9544 68 - 0
E. team.dach@megger.com

Megger Germany GmbH
Röderaue 41
01471 Radeburg
Germany
T. +49 (0) 35208 84 – 0
E. team.dach@megger.com

Megger Sweden AB
Rinkebyvägen 19
182 36 Danderyd
Sweden
T. +46 8 510 195 00
E. seinfo@megger.com

Megger Baker Instruments
4812 McMurry Ave., Suite 100
Fort Collins, CO 80525
United States
T. +1 970-282-1200
E. baker.sales@megger.com

Megger
4545 West Davis Street
Dallas, TX 75211
United States
T. +1 800-723-2861 ext. 6000
E. usasales@megger.com

Megger Germany assumes no responsibility for any errors that may appear in this document. The company reserves the right to change the specification or design without prior notice.

Megger is a registered trademark.