

Megger[®]

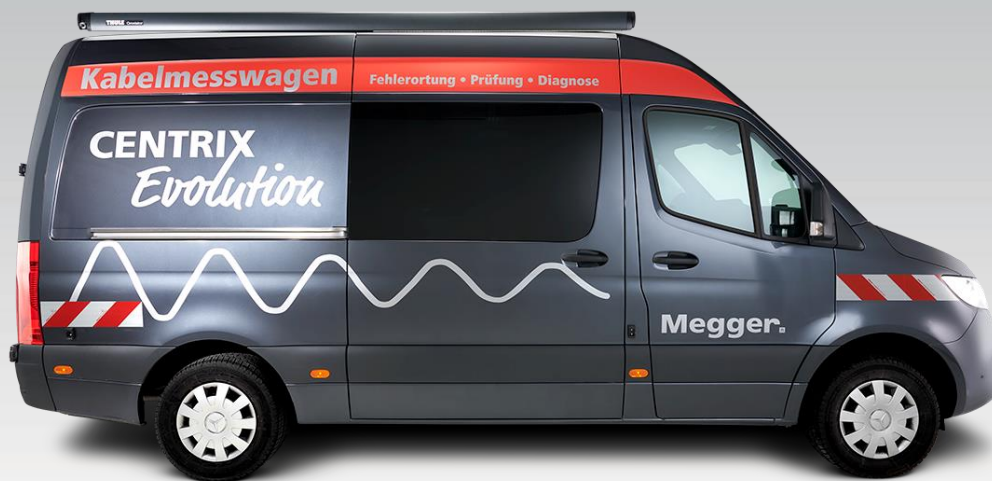

Centrix Evolution

Centrally controlled, fully automatic cable test van

OPERATION AND MAINTENANCE

Issue: D (06/2024) - EN
Article number: 86769



Terms of Warranty

Megger accept responsibility for a claim under warranty brought forward by a customer for a product sold by Megger under the terms stated below.

Megger warrant that at the time of delivery Megger products are free from manufacturing or material defects which might considerably reduce their value or usability. This warranty does not apply to faults in the software supplied. During the period of warranty, Megger agree to repair faulty parts or replace them with new parts or parts as new (with the same usability and life as new parts) according to their choice.

This warranty does not cover wear parts, lamps, fuses, batteries and accumulators.

Megger reject all further claims under warranty, in particular those from consequential damage. Each component and product replaced in accordance with this warranty becomes the property of Megger.

All warranty claims versus Megger are hereby limited to a period of 12 months from the date of delivery. Each component supplied by Megger within the context of warranty will also be covered by this warranty for the remaining period of time but for 90 days at least.

Each measure to remedy a claim under warranty shall exclusively be carried out by Megger or an authorized service station.

This warranty does not apply to any fault or damage caused by exposing a product to conditions not in accordance with this specification, by storing, transporting, or using it improperly, or having it serviced or installed by a workshop not authorized by Megger. All responsibility is disclaimed for damage due to wear, will of God, or connection to foreign components.

For damage resulting from a violation of their duty to repair or re-supply items, Megger can be made liable only in case of severe negligence or intention. Any liability for slight negligence is disclaimed.

Since some states do not allow the exclusion or limitation of an implied warranty or of consequential damage, the limitations of liability described above perhaps may not apply to you.

Contents

1	List of abbreviations	6
2	Safety and general information	7
2.1	Basic information	7
2.2	General warnings and safety instructions	9
3	Technical description	11
3.1	Functional description	11
3.2	Technical data	15
4	Safety devices	27
4.1	Safety devices F-U and F-ohm	28
4.2	Rear door monitoring	28
4.3	Emergency shutdown	29
4.4	Safety key switches	29
4.5	Discharging devices and residual voltage display	30
4.6	Signalling equipment	30
4.7	Reverse current detection (optional)	31
4.8	Automatic fire extinguisher (optional)	33
5	Setting up the test van and cordoning up the area	34
6	Electrical connection	35
6.1	Connection equipment	36
6.2	Connection of the earth cable	38
6.3	Connection to reference earth (F-U monitoring)	39
6.4	Connection to the test object	40
6.4.1	Using the HV connection cable	40
6.4.1.1	Step 1: Unwinding the cable	43
6.4.1.2	Step 2: Connecting to the device under test	44
6.4.1.3	Step 3: Connecting to the appropriate HV output	47
6.4.2	Using the three-phase LV connection cable (optional)	51
6.4.3	Using the MFM/HVB connection cable (optional)	51
6.5	Establishing the mains supply	52
6.5.1	Connection to mains supply	52
6.5.2	Operation via generator or battery power supply (optional)	53
6.6	Connection of the external safety device	54
6.7	Switching on the test van	56
7	Operation of the test van	57
7.1	Operating and display instruments in the control area	57
7.2	Switching on	59
7.3	Operation	60
8	Adjusting/disconnecting the electrical connection	61
9	Completing the work	62
10	IT accessories and connectivity	63

10.1	Use of USB accessories	63
10.2	Internet and GPS connectivity (optional)	64
10.3	Emergency operation via notebook	66
11	Troubleshooting	68
11.1	Behaviour in the event of faults during normal operation	68
11.1.1	Check fuses	68
11.1.2	Other possible fault causes	70
11.2	Behaviour in the event of continuous faults	71
12	Care and maintenance	72
12.1	Testing and maintenance measures to be carried out by the operator	72
12.2	Required maintenance by a service workshop	72

1 List of abbreviations

ARM	Arc Reflection Method
CR	Cosine Rectangular
DAC	Damped AC
FU	Fault Voltage
ICE	Impulse Current Measurement
IFL	Intermittent Fault Location
MWT	Monitored Withstand Test
NAS	Netzanschluss-System (Mains Connection System)
PDS	Partial Discharge Measuring System
PD	Partial Discharge
TDM	Test and Diagnosis Module
TDR	Time Domain Reflectometry
VLF	Very Low Frequency

2 Safety and general information

2.1 Basic information





Safety precautions

This manual contains basic instructions for the commissioning and operation of the device / system. For this reason, it is important to ensure that the manual is always available to the authorised and trained operator. He needs to read the manual thoroughly. The manufacturer is not liable for damage to material or humans due to non-observance of the instructions and safety advices provided by this manual.

Locally applying regulations have to be observed!

Signal words and symbols used

The following signal words and symbols are used in this manual and on the product itself:

Signal word / symbol	Description
DANGER	Indicates a potential hazard which will result in death or serious injury if not avoided.
WARNING	Indicates a potential hazard which may result in death or serious injury if not avoided.
CAUTION	Indicates a potential hazard which may result in moderate or minor injury if not avoided.
NOTICE	Indicates a potential hazard which may result in material damage if not avoided.
	Serves to highlight warnings and safety instructions. As a warning label on the product it is used to draw attention to potential hazards which have to be avoided by reading the manual.
	Serves to highlight warnings and safety instructions that explicitly indicate the risk of an electric shock.
	Serves to highlight important information and useful tips on the operation of the device/system. Failure to observe may lead to unusable measurement results.
	Serves as a reference to further information in other operating instructions.

Working with products from Megger

It is important to observe the generally applicable electrical regulations of the country in which the device will be installed and operated, as well as the current national accident prevention regulations and internal company directives (work, operating and safety regulations).

After working on the system, it must be voltage-free and secured against reconnection as well as having been discharged, earthed and short-circuited.

Use genuine accessories to ensure system safety and reliable operation. The use of other parts is not permitted and invalidates the warranty.

Operating staff

The system may only be installed and operated by an authorised electrician. DIN VDE 0104 (EN 50191), DIN VDE 0105 (EN 50110) and the German accident prevention regulations (UVV) define an electrician as someone whose knowledge, experience and familiarity with the applicable regulations enables him to recognise potential hazards.

Anyone else must be kept away!

Electromagnetic radiation

This device is designed for industrial use. When used at home it could cause interference to other equipment, such as the radio or television.

The interference level from the line complies with the limit curve B (living area), the radiation level complies with the limit curve A (industrial area) according to EN 55011. Given that living areas are sufficiently far away from the planned area of operation (industrial area), equipment in living areas will not be impaired.

2.2 General warnings and safety instructions

Intended application

The operating safety is only guaranteed if the delivered system is used as intended. Incorrect use may result in danger to the operator, to the system and the connected equipment.

The thresholds listed in the technical data may not be exceeded under any circumstances.

Operation in traffic environment

To ensure safety for operators and traffic, the country-specific regulations must be observed.

Five safety rules

The five safety rules must always be followed when working with HV (High Voltage):

1. De-energise
2. Protect against re-energising
3. Confirm absence of voltage
4. Earth and short-circuit
5. Cover up or bar-off neighbouring energised parts



Using cardiac pacemaker / defibrillator

Physical processes during operation of high voltage may endanger persons wearing a cardiac pacemaker or defibrillator when near these high voltage facilities.



Fire fighting in electrical installations

- According to regulations, **carbon dioxide (CO₂)** is required to be used as extinguishing agent for fighting fire in electrical installations.
- Carbon dioxide is electrically non conductive and does not leave residues. It is safe to be used in energized facilities as long as the minimum distances are maintained. A CO₂ fire extinguisher must be always available within electrical installations.
- If, contrary to the regulations, any other extinguishing agent is used for fire fighting, this may lead to damage at the electrical installation. Megger disclaims any liability for consequential damage. Furthermore, when using a powder extinguisher near high-voltage installations, there is a danger that the operator of the fire extinguisher will get an electrical shock from a voltage arc-over (due to the powder dust created).
- It is essential to observe the safety instruction on the extinguishing agent.
- Applicable is DIN VDE 0132.



WARNING

Dangers when working with high voltage

Working on high voltage systems and equipment – especially in non-stationary operation – requires particular care and safety-conscious action on the part of operating personnel. VDE regulations 0104 on setting up and operating electrical test systems, as well as EN 50191 and national standards and regulations must be strictly adhered to.

- The Centrix Evolution generates a dangerous voltage up to 80 kV during the measuring operation. This is fed into the test object via the HV connection cable.
- The test system may not be operated without supervision.
- Never fail to use safety equipment or put it out of operation.
- Operation requires minimum two people whereas the second person must be able to activate the emergency switch in case of danger.
- To prevent dangerous charge accumulation, earth all metal parts in the vicinity of the high voltage equipment.



Wear ear protection

Surge operation can cause high and sudden noise levels. It is strongly recommended to wear hearing protection during surge operation. Keep in mind that this will limit the operators awareness for ambient dangers.



Due to the increased formation of ozone, sufficient fresh air must be supplied to the operating room during operation.



Objects should not be placed on or lent against the heater, nor pushed between the heater and wall.

Do not cover the air exit or leave any combustible material in close vicinity to the heater.



Peripheral devices

Please follow the safety instructions of the peripheral devices (e.g. heater) installed in the system environment. For all peripheral devices provided by Megger, the instructions manual is included in the scope of delivery. Megger is not liable for damage to material or humans due to misuse of these devices.

3 Technical description

3.1 Functional description

The Centrix Evolution is a modern, flexible and powerful cable test van for fast, simple and cable-friendly fault detection up to the voltage range 36 kV. The system has the measurement procedures and technical equipment required for successful cable fault detection and pinpointing.

Optionally equipped with powerful VLF test technology and modern diagnostic solutions, the Centrix Evolution also enables standard-compliant cable testing, loss factor measurement and partial discharge diagnostics.



Operation of the system is menu-driven via a central operating unit, which also enables automatic storage and logging of the test results. All system functions, measurement results, operating instructions and error messages are shown on a single display.

The integrated safety system with its reliable safety devices permanently monitors the safety of the operating personnel and the devices.

Features

The universal **basic system** always includes the following measuring methods:

- Fault identification with insulation testing and automatic breakdown detection
- Fault prelocation with proven HV locating methods such as arc reflection measurement (ARM Best Picture Multishot), voltage decoupling (DECAY) and current decoupling (ICE)
- Fault prelocation with conditioning (ARM Conditioning)
- Fault conversion by burning the fault location
- Sheath test with automatic breakdown detection
- Pinpoint location of sheath faults according to the step voltage method
- Fault pinpointing in surge operation
- Line and fault detection by means of audio frequency signal
- DC testing















Depending on the add-on equipment, the following measurement and diagnostic applications are also available as **options**:













- VLF test with cosine rectangular and/or sinusoidal voltage
- Burning at the fault location with simultaneous fault detection (ARM Burning)
- Dielectric loss factor measurement (TanDelta)
- Partial discharge diagnostics with different voltage forms

In addition to the mentioned measurement and diagnostic technologies, the system offers the following features:

- Highest safety standards
- Intuitive operation via touch display
- Workflow-supported automation of typical measuring and testing processes
- High system stability thanks to the Linux® operating system
- Self-powered (optional)
- Integrated protocol software with cable database for instant reporting
- Connectivity and wireless communication interfaces (4G, WiFi, GPS) (optional)
- Transfer and synchronisation of measurement and cable data via a cloud database (optional)
- Remote control of important pinpointing and line location methods via app (optional)
- TeamViewer remote access for support and demonstration purposes (optional)
- Integration of supplied customer equipment (optional)

Equipment matrix

		Basic system	Optional
Test			
Insulation test		via HV cable	
			via LV cable
			with external measuring device
DC voltage test		up to 80 kV	
			up to 45 kV („Ambition M“) up to 62 kV („Basic“ or „Ambition L“)
VLF test with cosine rectangular voltage			up to 40 kV _{RMS} / 5 µF („Ambition M“) up to 54 kV _{RMS} / 5 µF („Professional 54“) up to 60 kV _{RMS} / 4,4 µF („Ambition L“) up to 62 kV _{RMS} / 3,2 µF („Professional 62“)
VLF test with sinusoidal voltage			bis 62 kV _{PEAK} / 1 µF („Basic“ or „Ambition L“)
Sheath test		up to 20 kV	
			with MFM 10 (up to 10 kV)
Fault location			
Pulse reflection measurement		via HV cable	
			via LV cable
Pulse reflection measurement in the event of intermittent errors		via HV cable	
			via LV cable
ARM Best Picture Multishot (arc reflection measurement)		■	
ARM Conditioning		■	
DECAY method		up to 80 kV	
DECAY Plus			up to 80 kV
ICE current pulse method		■	

		Basic system	Optional
ICE three-phase			■ (for three-phase systems only)
ARM Live Burning			via resonance burner VPK 1 (up to 20 kV)
Sheath fault pre-location			with MFM 10 (up to 10 kV)
Fault conversion			
Burning		up to 80 kV	
Power burning			via resonance burner VPK 1 (up to 20 kV/25 A)
Fault pinpointing			
Surge pinpointing		8/16/32 kV @ 2000 J	4 kV surges: 2/4 kV @ 2000 J
ICE surging			Surge energy increase: 4/8/16/32 kV @ 4000 J
Audio frequency generator			200 W
Sheath fault pinpointing		up to 20 kV	
			with MFM 10 (up to 10 kV)
Diagnostics			
Voltage withstand test with simultaneous TanDelta measurement			with diagnostic packages "Basic", "Advanced" or "Ultimate"
TanDelta step test			
PD diagnostics with sinusoidal voltage			up to 62 kV _{PEAK} („Basic“, „Advanced“ or Ultimate“)
PD diagnostics with cosine rectangular voltage (50 Hz Slope technology)			up to 40 kV _{RMS} („Dynamic M“ or „Ultimate M“) up to 60 kV _{RMS} („Dynamic L“ or „Ultimate L“)
PD diagnostics with DAC voltage			up to 40 kV _{RMS} („Dynamic M“ or „Ultimate M“) up to 60 kV _{RMS} („Dynamic L“ or „Ultimate L“)

3.2 Technical data



The technical data of the additional measuring equipment contained in the measuring trolley (e.g. PD coupler, sheath tester, surge wave receiver) and the peripheral devices (e.g. generator system) can be found in the corresponding documentation.

General data of the test van

Parameter	Value
Mains voltage	230 V, 50 Hz or country-specific mains voltages (120 V, 110 V) Connection via isolating transformer
Generator system	Optional (e.g. Voltstar) up to 8 kVA
Connection power	3.6 kVA (optional up to 8 kVA)
Connection equipment	
■ HV connection cable	50 or 80 m
■ Power cord	50 m (incl. suitable isolating transformer and mains connection system NAS)
■ Earth cable	50 m
■ F-U connection cable	10 m
■ External safety device connection cable	15 or 50 m
■ Three-phase LV connection cable (optional)	50 m

Parameter	Value
Safety	
<ul style="list-style-type: none"> ■ Electrical safety 	according to DIN EN (IEC) 61010-1
<ul style="list-style-type: none"> ■ Safety and protective equipment 	<p>The following conditions are monitored during operation:</p> <ul style="list-style-type: none"> ■ Earth loop monitoring (F-ohm) ■ Monitoring for dangerous potential increases (F-U) ■ Monitoring for rapid voltage rises ■ Rear door switch ■ Safety key switches ■ Emergency off switch internal/external (EN 50191) ■ External safety device with emergency off and signalling ■ Reverse current detection (optional)
<ul style="list-style-type: none"> ■ Discharge 	<p>32 kJ (10 μF) at 80 kV</p> <p>Safe discharge even in the event of an emergency shutdown or mains failure thanks to SafeDischarge technology</p>
<ul style="list-style-type: none"> ■ Supply voltage 	Overvoltage protection, undervoltage protection, RCD
Industrial PC	
<ul style="list-style-type: none"> ■ Processor 	Intel® Core™ i series (Dual Core 64-bit)
<ul style="list-style-type: none"> ■ Hard disk 	256 GB SSD
<ul style="list-style-type: none"> ■ Display 	21.5" TFT multitouch screen, Full HD, 1980 x 1080 pixels
<ul style="list-style-type: none"> ■ Operating system 	Linux®
<ul style="list-style-type: none"> ■ Software 	Proprietary measurement and logging software with database

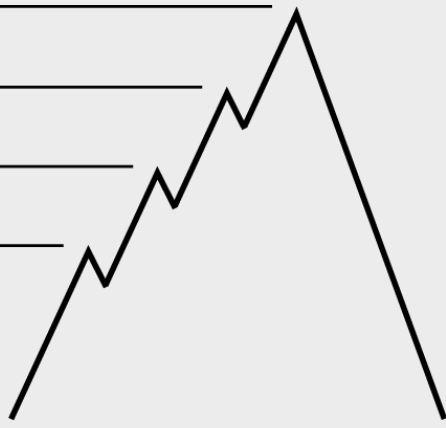
Parameter	Value
Connectivity	
■ Standard	USB 3.0, Ethernet (for service purposes)
■ With optional 4G/GPS router	Mobile data (GPRS/EDGE/3G/4G), Wi-Fi, GPS
■ External sockets (AUX)	For test devices with max. output voltage / current of 2.5 kV / 1 A Required connection cables: Stäubli XHM-5000 (or comparable)
Operating temperature	
■ HV unit	-25°C ... +55°C
■ Industrial PC	0°C to +55°C
Storage temperature	-25°C ... +70°C
Operating humidity	93% at 30°C (non-condensing)
Operating altitude	<p>Depending on the operating altitude, the following limit values must be considered when setting the voltage:</p> <p><5000 m → $0.6U_{max}$</p> <p><4000 m → $0.7U_{max}$</p> <p><3000 m → $0.8U_{max}$</p> <p><2000 m → U_{max}</p>  <p>U_{max} refers to the maximum voltage of the respective voltage source.</p>

Technical data of the measuring system

Parameter	Value
Insulation measurement	
■ Measurement voltage	<6 V, 500 V, 1000 V
■ Measuring range resistance	1 Ω to 2 kΩ (at <6 V) 1 kΩ to 2 GΩ (at 500 V) or 1 kΩ to 2 GΩ (at 1000 V)
■ Measuring range capacity (only with 500 V or 1000 V)	0 to 20 μF (resolution 0.1 μF)
■ Trend measurement (only with 500 V or 1000 V)	up to 15 minutes
TDR module (time range reflectometer)	
■ Operating modes	Symmetrical/asymmetrical reflection measurement, differential and comparison measurement between different phases, IFL (for localisation of intermittent faults)
■ Dynamic range	115 dB
■ ProRange (distance-dependent attenuation)	+40 dB
■ Measuring range (at $v/2 = 80 \text{ m}/\mu\text{s}$)	20 m to 1280 km
■ Resolution	0.1 m
■ Value range $v/2$	10 to 149.9 m/ μs
■ Accuracy	0.1% relative to measuring range
■ Sample rate	533 MHz
■ Time base accuracy	<50 ppm
■ Output impedance	50 Ω
■ Pulse width	20 ns to 30 μs
■ Pulse amplitude	up to ±250 V

Parameter	Value
DC voltage test	
■ Test voltage	0 to 80 kV
■ Rated current	195 mA (0 to 8 kV) 13.5 mA (8 to 80 kV)
■ Short-circuit current	550 mA
Sheath test/sheath fault pinpointing	
■ Test voltage	0 to 5 kV, 0 to 10 kV, 0 to 15 kV, 0 to 20 kV
■ Maximum current	≤5 kV: 550 mA >5 kV: 155 mA
■ Clock ratio (tracking)	0.5:1 / 1:3 / 1:4 / 1:6 / 1:12
ARM Best Picture Multishot	
■ Surge voltage	0 to 32 kV
■ Number of error images	32
DECAY (voltage decoupling)	
■ Voltage	0 to 80 kV
DECAY Plus (double surge) (optional)	
■ Low voltage trace pulse	1.5 kV
■ Fault ignition	Charging with 0 to 80 kV until breakdown; followed by a 4 kV pulse to stabilise the arc
ICE (current decoupling)	
■ Surge voltage	0 to 32 kV
ICE three-phase (optional)	
■ Surge voltage	0 to 32 kV

Parameter	Value
Burning via internal high-voltage cascades	
■ Output voltage	0 to 80 kV
■ Max. burning current	550 A (0 to 8 kV) 170 A (8 to 80 kV)
■ Max. burning time	60 minutes
ARM Live Burning (optional)	
■ Output voltage	0 to 8 kV (via internal high-voltage cascades) 0 to 20 kV (with optional resonance burner VPK-1)
■ Max. burning current	515 mA (via internal high-voltage cascades) 25 A (with optional resonance burner VPK 1)
■ Max. burning time	30 minutes
Surge pinpointing	
■ Voltage levels	Standard: 0 to 8 kV, 0 to 16 kV, 0 to 32 kV Options: 0 to 2 kV, 0 to 4 kV
■ Surge energy	Standard: 2000 J at 2, 4, 8, 16 and 32 kV Surge energy boost option: 4000 J at 4, 8, 16 and 32 kV
■ Surge sequence	3 - 30 surges/min (adjustable) or single surge
Audio frequency generator (FLG)	
■ Frequencies	0.491 kHz, 0.982 kHz, 8.440 kHz (customer-specific frequencies are possible)
■ Output power	250 W

Technical data of the resonance burner VPK 1 (optional)

Parameter	Value
Output voltage	0 to 20 kV DC
Max. burning current	25 A DC
Max. burning time	30 minutes

Technical data of the testing packages „Professional 54“ and „Professional 62“ (optional)

Parameter	Value
Test voltage	0 ... 54 kV / 62 kV
Testable load capacity	21 μ F at 18 kV at 0.1 Hz 8 μ F at 36 kV at 0.1 Hz 5 μ F at 54 kV at 0.1 Hz 3.2 μ F at 62 kV at 0.1 Hz

Technical data of the testing and diagnostic packages „Ambition M“, „Dynamic M“ and „Ultimate M“ (optional)



Which voltage forms are actually available depends on the selected testing and diagnostic package.

Parameter	Value
Output voltage	
■ Sinusoidal	2 to 32 kV _{RMS} / 45 kV _{peak}
■ DC	± 2 to ± 45 kV
■ Rectangular	± 2 to ± 45 kV
■ Cosine rectangular	± 3 to ± 40 kV _{RMS}
■ DAC (damped AC)	± 3 to ± 40 kV _{PEAK}
Max. output current source	12 mA _{RMS} (at rated voltage)

Parameter	Value
Leakage current measurement	(Rectangular, VLF-CR and DC operation)
■ Display range	0 to 20 mA
■ Resolution	10 μ A
Frequency	
■ Sinusoidal/rectangular voltage	0.01 Hz to 0.1 Hz
■ Cosine rectangular voltage	0.1 Hz
■ DAC voltage	20 Hz to 500 Hz
Testable load capacity	(see also the following diagrams)
■ Sinusoidal voltage	0.6 μ F at 45 kV _{PEAK} / 0.1 Hz
■ Rectangular voltage	0.6 μ F at 45 kV / 0.1 Hz
■ DC voltage	5 μ F at 45 kV
■ Cosine rectangular voltage	5 μ F at 40 kV _{RMS}
■ DAC voltage	5 μ F at 40 kV _{PEAK}
■ Maximum load capacity	10 μ F at reduced voltages and frequencies
Tan delta measurement (optional)	
■ Measuring range	10 ⁻³ to 10 ⁰
■ Accuracy (at a load capacity >20 nF)	1 x 10 ⁻³ or 1%
■ Resolution	1 x 10 ⁻⁴

The following graph **applies to tests with sinusoidal voltage** and illustrates the dependence of the test frequency on the capacity of the connected load and the set test voltage. If a test frequency cannot be applied due to the capacity limits specified here, an automatic adjustment is made and the user is informed about this condition.

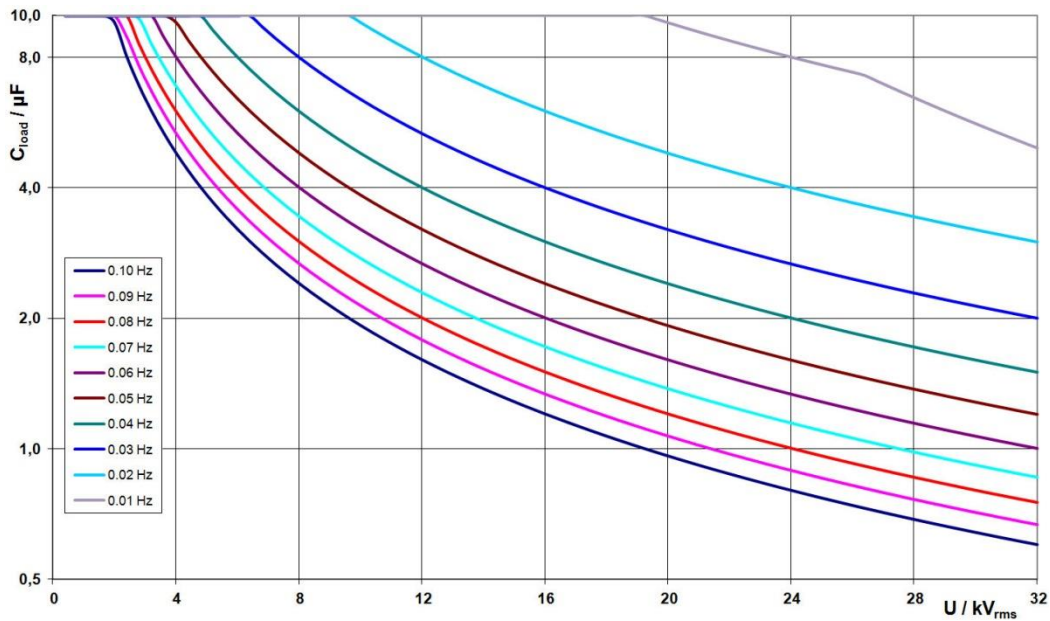

In **cosine rectangular or DAC mode**, the following load graph also applies¹:

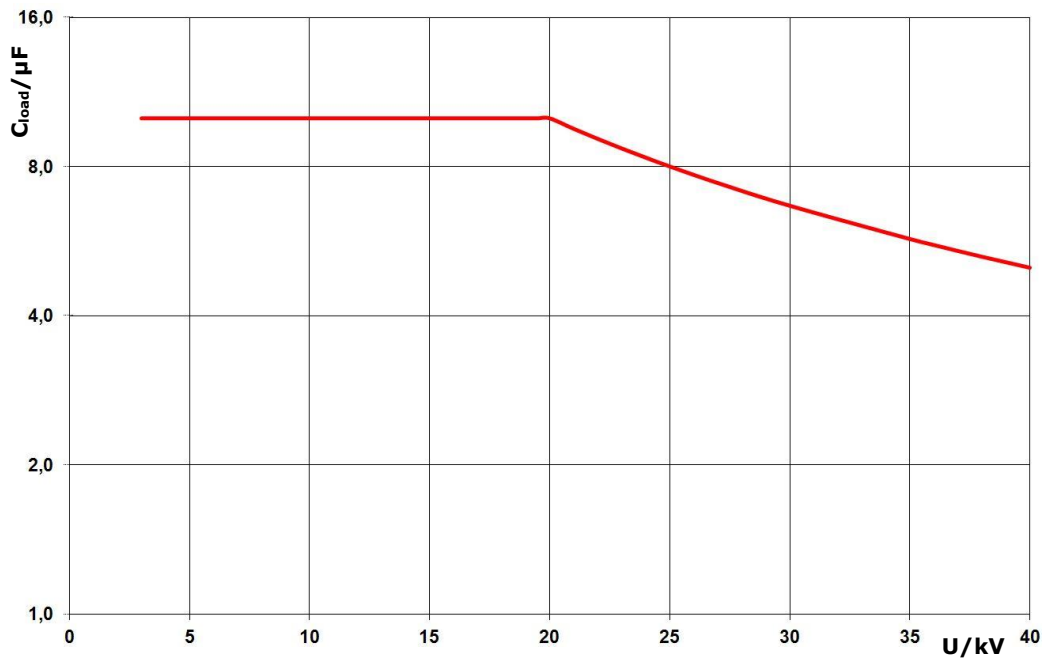

¹ Only valid between -25 and 45°C. In the temperature range from 45°C to 55°C, the power is reduced to 80% at 40 kV.

Technical data of the testing and diagnostic packages „Basic“, „Ambition L“, „Dynamic L“ and „Ultimate L“ (optional)

Parameter	Value
Output voltage	
■ Sinusoidal	2 to 44 kV _{RMS} / 62 kV _{peak}
■ DC	±2 to ±62 kV
■ Rectangular	±2 to ±62 kV
■ Cosine rectangular	±3 to ±60 kV _{RMS}
■ DAC (damped AC)	±3 to ±60 kV _{PEAK}
Max. output current source	23 mA _{RMS} (at rated voltage)
Leakage current measurement	(Rectangular, VLF-CR and DC operation)
■ Display range	0 to 20 mA
■ Resolution	10 µA
Frequency	
■ Sinusoidal/rectangular voltage	0.01 Hz to 0.1 Hz
■ Cosine rectangular voltage	0.1 Hz
■ DAC voltage	20 Hz to 500 Hz
Testable load capacity	(See also the following diagrams)
■ Sinusoidal voltage	1.0 µF at 62 kV _{PEAK} / 0.1 Hz
■ Rectangular voltage	1.0 µF at 62 kV / 0.1 Hz
■ DC voltage	5 µF at 62 kV
■ Cosine rectangular voltage	4.4 µF at 60 kV _{RMS}
■ DAC voltage	4.6 µF at 60 kV _{PEAK}
■ Maximum load capacity	10 µF at reduced voltages and frequencies

Parameter	Value
Tan delta measurement (optional)	
■ Measuring range	10^{-4} to 10^0
■ Accuracy (at a load capacity >20 nF)	1×10^{-4}
■ Resolution	1×10^{-5}

The following graph **applies to tests with sinusoidal voltage** and illustrates the dependence of the test frequency on the capacity of the connected load and the set test voltage. If a test frequency cannot be applied due to the capacity limits specified here, an automatic adjustment is made and the user is informed about this condition.

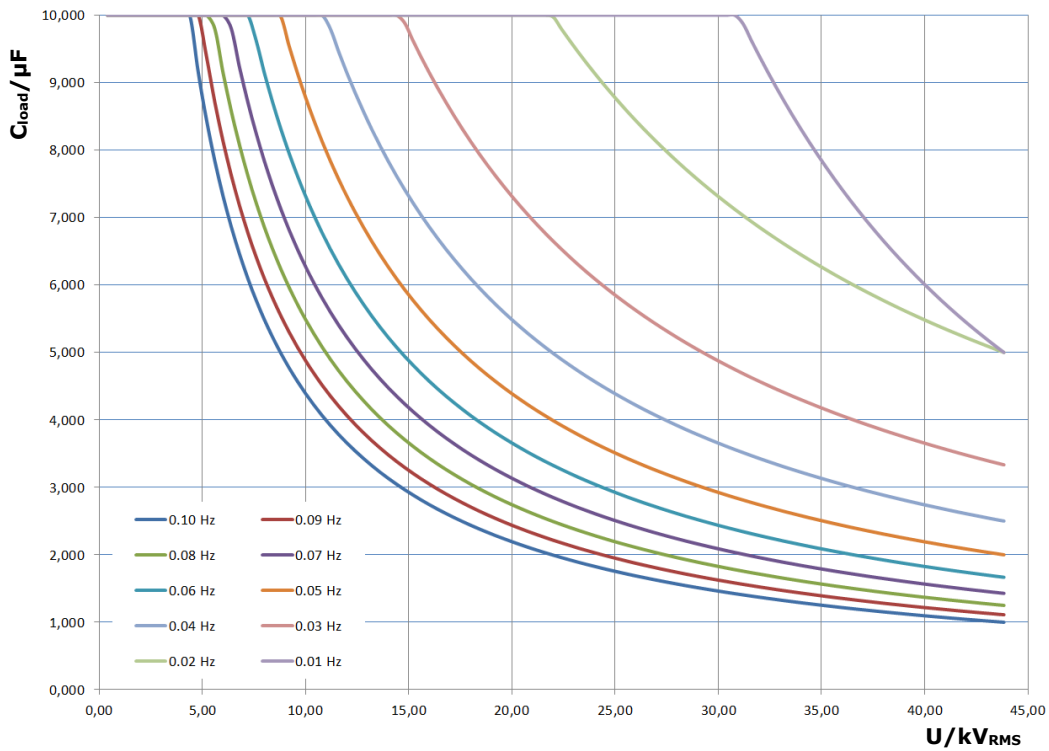

In **cosine rectangular or DAC mode**, the following load graph also applies²:

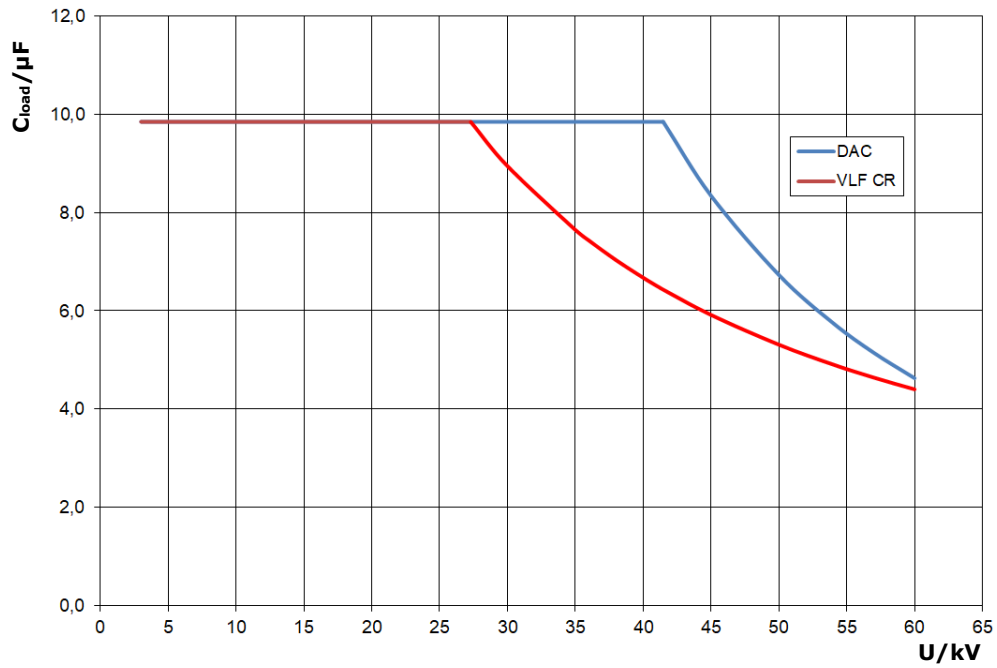

² Only valid between -25 and 45°C. In the temperature range from 45°C to 55°C, the power is reduced to 80% at 40 kV.

4 Safety devices

The safety of the operator and the operational readiness of the system are ensured by a variety of intelligent and proven safety devices, which serve to comply with the applicable occupational health and safety guidelines.

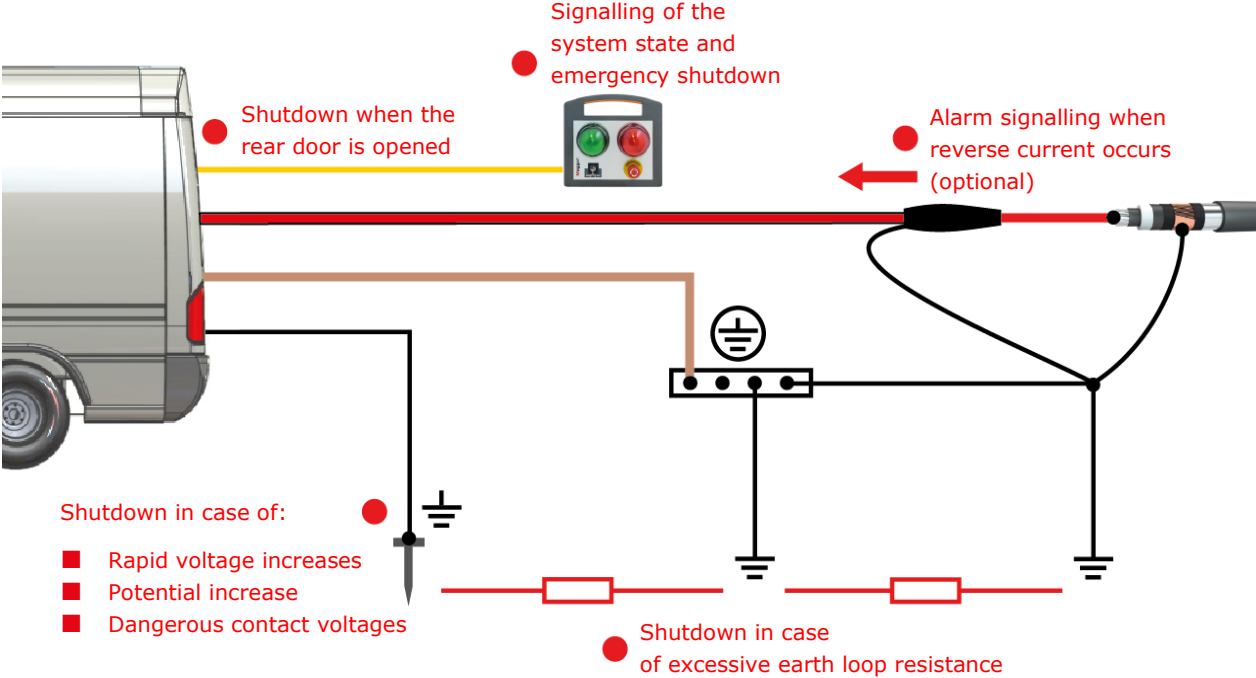

4.1 Safety devices F-U and F-ohm



WARNING

Risk of electric shock

Safety devices must not be bridged or neutralised!

Proper functioning of the protective devices described below requires that all earth connections (earth cable, F-U cable and cable shield of the connection cable) have been connected to the respective earthing points in accordance with the instructions in this manual.

To ensure sufficiently good earthing and low loop resistances, as well as to protect against voltages dangerous to the touch, a number of conditions are permanently monitored by the two monitoring devices F-U and F-ohm during operation. While the F-ohm protective device monitors the loop resistance (which must not exceed 10Ω) between the cable shield of the connection cable and the protective earth (station earth), the F-U protective device is responsible for the actual earth monitoring and ensures compliance with the following conditions:

- The voltage difference between the test van and the surrounding earth (auxiliary earth) must not exceed 20 VAC or 44 VDC
- The measured voltage-time area must not exceed 50 V/20 ms
- The transfer resistance between the earth spike and the station earth must not exceed 120 k Ω

As soon as one of the two protective devices detects an impermissible deviation, any high-voltage operation is immediately interrupted automatically and the measuring circuit is discharged via the discharging device. It is only possible to switch on the high voltage again after the earthing conditions have been improved and the measured values are within the tolerance.

4.2 Rear door monitoring

To ensure contact protection for the live parts in the test van, the position of the rear doors is monitored by means of contacts. High-voltage operation is not possible if the rear doors are not closed. If the rear doors are opened during ongoing high-voltage operation, the system is immediately switched off and discharged.

4.3 Emergency shutdown

In the event that an immediate emergency shutdown is required in measuring mode, one of the available emergency off switches must be activated.

These are located on the control panel in the control area (see page 57), on the external safety device (see page 54) and optionally at other quickly accessible positions in the test van.

In the event of a deviation, any high-voltage operation is immediately interrupted automatically and the measuring circuit is discharged via the discharging device. In addition, the power supply to the measuring system is interrupted. However, the outlets in the control area are still live.

4.4 Safety key switches

For reasons of liability, it must be ensured that measuring systems that emit a hazardous voltage can be secured against unauthorised access. This is made possible by the two safety key switches on the control panel in the control area (see page 57) and on the external safety device (see page 54).

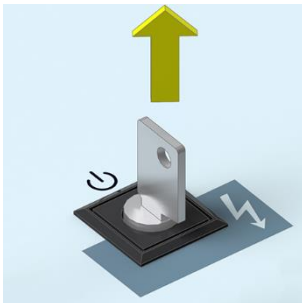

The key switch is locked and high-voltage preparation is not possible. When locked, the key can be removed and the system secured against unauthorised high-voltage operation.

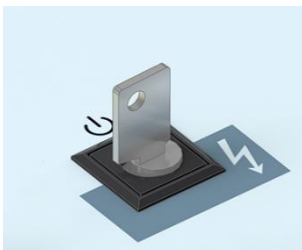

The key switch is unlocked and high-voltage preparation is possible, provided that all other safety conditions are also met.

4.5 Discharging devices and residual voltage display

The test van is equipped with discharging and earthing devices via which the HV output of the system is safely and quickly discharged and earthed during both manual and automatic shutdown.

Thanks to the heavy-duty switches used, all system components can be safely discharged even in the event of a mains failure.

After discharge, the residual voltage display on the control panel can be used to determine the absence of voltage. This analogue measuring instrument uses its two scales to monitor both the HV output of the actual measuring system and the HV output of any test and diagnostic module (TDM) that may be present.

No voltage at both HV outputs



Residual voltage at the HV output of the measuring system

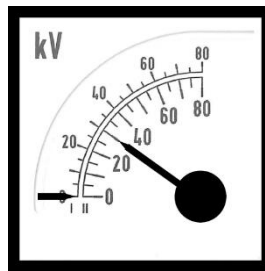

Residual voltage at the HV output of the TDM

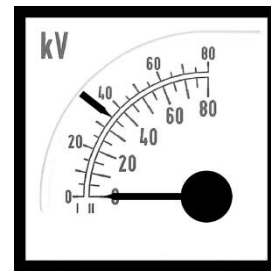

WARNING

Risk of electric shock

The residual voltage display can fail and should only be used as an aid. Even if no residual voltage is indicated, the 5 safety rules must be observed!

Optionally, the test van is also equipped with an appropriately dimensioned discharge and grounding rod with which system parts that have been under voltage can be visibly discharged and earthed.

4.6 Signalling equipment

To ensure widely visible signalling of the switching status as required by the relevant standards (e.g. EN 50191), a Megger measuring system built into the vehicle by itself is equipped with at least two signalling devices. These are located in the control area and outside on the external safety device (see page 54), so that both the operating personnel and people in the vicinity of the test van are alerted to the danger of high voltages.

If the **green light** is active, the system has been powered on but has not yet been put into high voltage operation.

The **red light** comes on as soon as high voltage can be generated. All discharge and earth devices are open and the test object is to be considered "live".

4.7 Reverse current detection (optional)



WARNING

Risk of electric shock

Reverse current detection is used exclusively to signal a reverse current that occurs. Contact separation or similar measures are not carried out automatically. Even if the vehicle is equipped with reverse current detection, the five safety rules and the connection sequence specified in this manual must be observed.



The manufacturer is not responsible for the costs of countermeasures initiated as a result of a false triggering which cannot be ruled out 100%.

Description

The optional reverse current detection is used to detect and signal impermissible 50/60 Hz load currents from the cable network to which the test van has been connected. The detection threshold for impermissible currents is $I > 65 \text{ A (+10\%)}$ at 50 Hz AC. Reverse currents at this level can occur, for example, in the event of an accidental connection or when connecting to a live cable. Currents flowing in the operational earth lead, in the protective conductor or in the auxiliary earth lead of the test van are detected.

Reverse current detection operates independently of the function of the test van, and without an external power supply. The energy for the acoustic and optical alarm is derived from the measuring signal.

Operating and display elements

The operating and display elements of reverse current detection are normally located on the control panel in the control area and in the terminal compartment (signal lamp only).



Number	Description
1	Lamp for signalling a detected reverse current. A second signal lamp of this type is installed in the terminal compartment. The optical signalling is accompanied by a loud horn sound.
2	Test button that can be used to trigger a function test of the reverse current detection (press for longer than 1 second). Such a function test should be carried out at regular intervals. Just like a real alarm, the test alarm can be acknowledged afterwards by pressing the Reset button.
3	The Reset button is used to acknowledge an alarm or function test, and switches off the optical and acoustic signalling.

Behaviour in the case of reverse current signalling

As soon as a return current is signalled by the lamp and the alarm horn, appropriate measures must be taken immediately to interrupt the current flow. During all these measures it is imperative that the five safety rules (see page 9) are applied.

After the current flow has been successfully interrupted the alarm can be acknowledged by pressing the **Reset** button; the reverse current detection can also be reset in this way.

4.8 Automatic fire extinguisher (optional)

The automatic fire extinguisher is a plastic container filled with 580 ml of special liquid which is optionally fitted in the area of the high-voltage components.

As soon as the liquid reaches a temperature of 84°C as a result of a fire, the fire extinguisher is triggered automatically and distributes the liquid over the source of the fire. This causes the temperature to drop and deprive the fire of oxygen, which in most cases results in the fire being extinguished quickly. As the extinguishing liquid is dispersed like a mist, there is no risk of electric shock or short circuit.

If desired, the automatic fire extinguisher can also be retrofitted.

5 Setting up the test van and cordoning up the area

The guidelines for implementation of occupational safety when operating a test system / test van often differ between one network operator and another and it is not uncommon for national regulations (like, i.e. the German BGI 5191) to be used as well. Inform yourself of the guidelines applicable in the area of operation beforehand, and comply with the specified rules for work organization and for implementing the test system / test van.



WARNING

Risk of electric shock

- The test van must never be placed directly over the route of the cable to be tested!
- To ensure that the integrated gravity switches function correctly, the test van must never be operated on inclines that exceed 10%.
- The test van must not show any visible damage, e.g. accident damage, as long as this has not yet been classified as harmless by a Megger service center!
- If the height at the job site exceeds 2000 m, the maximum voltage limit values defined in the technical data must be complied with due to the reduced dielectric strength of the air gaps.
- In the event of large differences in temperature between the storage and installation locations (cold to warm) condensation may form on components carrying high voltage (condensation effect). To avoid any risk of damage to people and devices caused by voltage flash-overs, the system must not be operated when in this condition. It should rather be left in the new environment to acclimatise for approximately one hour before putting it into operation.

The following steps must be carried out to adequately secure the test van and the surrounding area:

1. Place the test van on level ground and close to the access to the test object, taking into account its load and external dimensions. Check that the test van is in a stable position.
2. Secure the test van against rolling away by applying the handbrake and positioning chocks against the wheels if necessary.
3. To keep people away from the test van and its connection cables, secure the immediate vicinity of the test van in accordance with local regulations using barriers, warning signs and cable bridges.

6 Electrical connection

The following figure shows the simplified connection diagram:

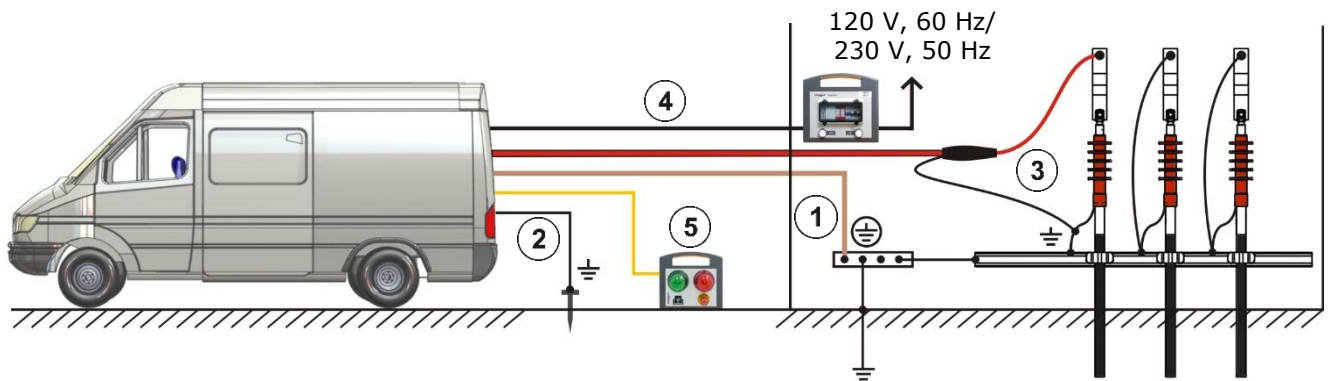

WARNING

Risk of electric shock

The electrical connection must be carried out in the sequence shown in the image. The ground cable must be connected first and the mains connection is made last!

For disconnection, follow the sequence in reverse order.

Follow the specified connection sequence:

- ① Connection of the earth cable (see page 38)
- ② Connection of F-U monitoring (reference earth) (see page 39)
- ③ Connection to the test object (see page 40)
- ④ Mains connection (see page 52)
- ⑤ Connection of the external safety device (see page 54)

6.1 Connection equipment



The arrangement and equipment of the connection system may differ depending on the vehicle type and equipment variant.

Example configuration of a single-phase system without test and diagnostic accessories

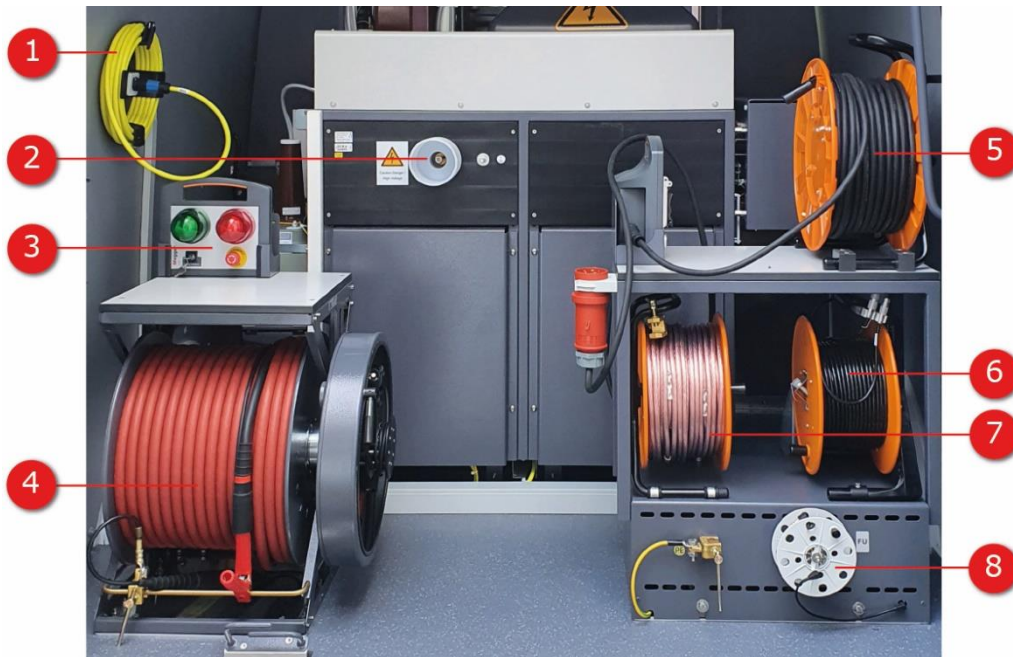

Number	Description
1	Cable for connecting the external safety devices (depending on length, can also be on a drum)
2	HV output of the system. Systems with Test and Diagnostics Module (TDM) have an additional HV output and are accordingly equipped with a remote connection panel.
3	External safety device (see page 54)
4	HV connection cable
5	Power cord
6	LV connection cable
7	Earth cable
8	Reference earth cable (F-U monitoring)

Example configuration of a three-phase system with test and diagnostic accessories

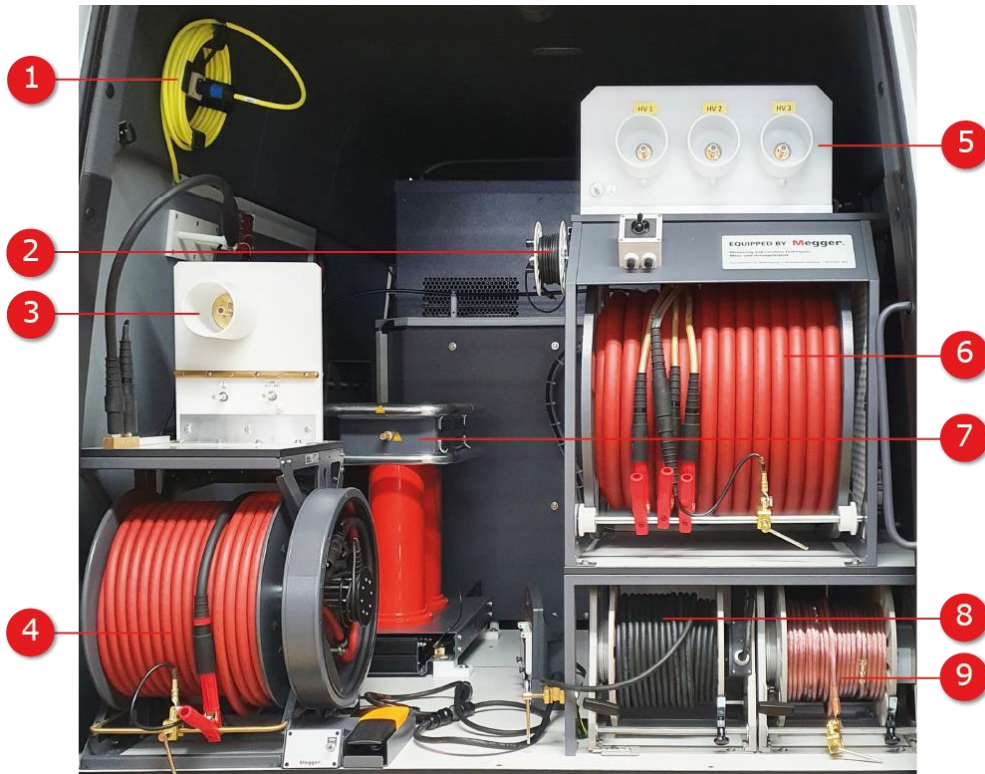

Number	Description
1	Cable for connecting the external safety devices (depending on length, can also be on a drum)
2	Reference earth cable (F-U monitoring)
3	PD-free HV connection panel for diagnostic operating modes
4	PD-free HV connection cable for diagnostic measurements
5	HV connection panel for three-phase connection for test and fault location operating modes
6	Three-phase HV connection cable
7	Partial discharge measuring system
8	Power cord
9	Earth cable

6.2 Connection of the earth cable



WARNING

Risk of electric shock

- The test van must never be operated without a connected earth cable. The earth cable provides the connection between the system and the protective earth and ensures that the entire system is safe to touch.
- The test van may only be connected to earth systems or single earth conductors with transition resistors $<2 \Omega$.
- Protective earth (earth cable) and system earth (shield of the HV cable) must be connected in such a way that no impermissible voltage difference can arise between protective earth (PE) and neutral conductor (N).
- For TT networks, there is no connection between the neutral conductor (N) and protective earth (PE) in the station. A suitable cable must be used to establish the connection for the measurement.

To connect the earth cable, proceed as follows:

1. Release the brake on the earth cable drum.
2. Unwind the cable as far as necessary and connect it to the station earth or another suitable foundation earth.
3. Clamp one of the contact sleeves attached to the cable at intervals of a few metres under the connecting clamp next to the cable drum.

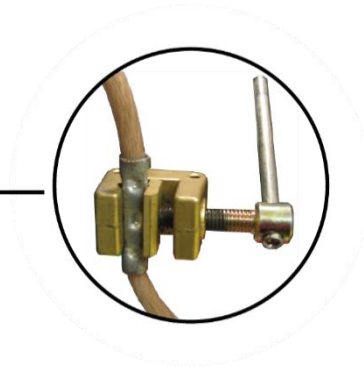
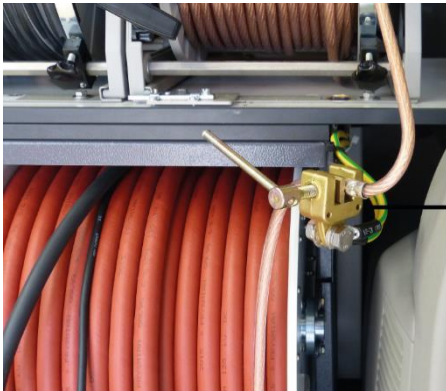

4. Secure the cable drum brake again.

6.3 Connection to reference earth (F-U monitoring)



The direct connection between the measuring system and the surrounding earth (reference earth) is essential for functioning earth monitoring (F-U) and a safe measuring operation (see page 28). Even in heavily built-up areas where it is difficult to insert the earth spike this protective device must not be bridged and neutralised! The following measures can help to establish a sufficiently low-impedance earth connection:

- Use the joints between concrete slabs to make contact with the earth spike.
- Moisten the place where the earth spike was inserted with water.
- If necessary, attach the F-U cable to a foundation earth electrode (e.g. a lightning protection system). However, do not use the same earthing point to which you have already connected the main earth cable.

To establish the reference earth connection:

1. Disconnect the system's connection cable from the F-U cable drum.

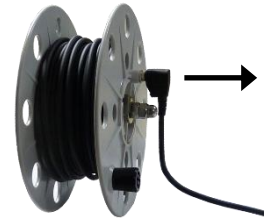

2. Place the supplied earth spike into the ground in the immediate vicinity of the test van and attach the end of the F-U cable to it.



3. Reconnect the system's connection cable to the F-U cable drum.

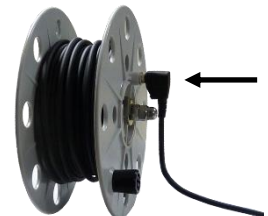

6.4 Connection to the test object



WARNING

Risk of electric shock

- Before connection to the test object, the five safety rules (see page 9) must be applied.
- All phases of the test object which are not being tested must always be short-circuited and earthed.
- Protective devices (guard rails, chains, bars etc.) must be installed on the test object as a barrier to prevent contact with active parts and to ensure that the danger zone cannot be accessed.
- Since the voltage applied to the test object can assume hazardous values, all cable ends must be isolated to prevent contact. It must be ensured that all branching points are considered.

6.4.1 Using the HV connection cable

Instructions for operating the cable drum



CAUTION

Before using the motor drive, always connect the earth cable of the test van to protective earth first.



CAUTION

Risk of crushing



To prevent fingers and hands becoming crushed during the motorised winding of the HV connection cable, the wearing of suitable protective gloves and careful handling is recommended.

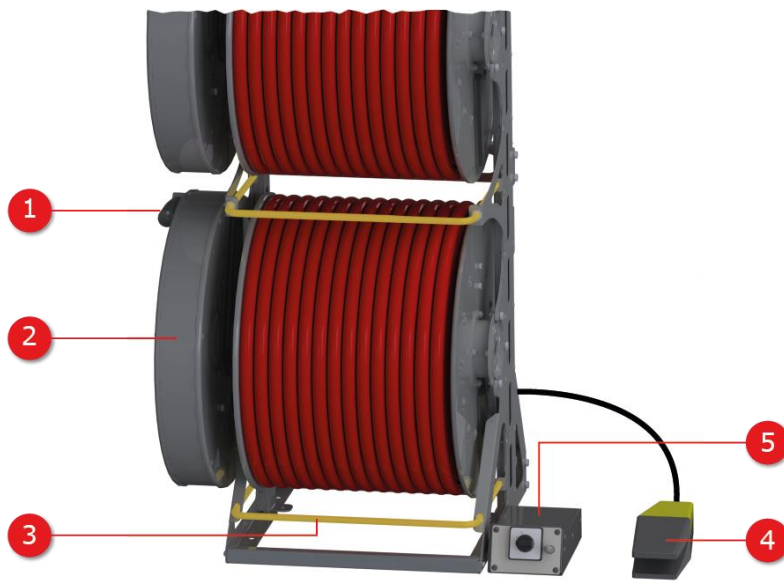

If the system is a custom solution with a custom-built connector panel and/or connection accessories that are different, please refer to the signs on the inside of the rear door for details on the electrical connection of the test object.

Single-conductor cable version (for single-phase and three-phase systems)



Number	Description	
1	Hand crank to manually wind and unwind the drum (only available with manual version)	
2		<p>Storage space for the system-side end of the HV connection cable.</p> <p>The cable end must always be properly stowed in the drum body before the HV connection cable can be unwound or wound.</p>
3	Earth rail for short circuit and earthing of the cable ends when the HV connection cable is not in use.	
4	Foot pedal for motor-assisted winding of the drum (only available on motorised version). The drum is manually unwound by pulling the cable.	
5		<p>Motor control and fuse protection (only available with motorised version).</p> <p>The circuit breaker trips when the drum motor is overloaded and disconnects the control unit from the power supply. After tripping, ensure that the cable runs freely and push the circuit breaker back in. Then continue the drum operation.</p> <p>The position of the phase selector switch (only available on three-phase systems) determines the cable drum, which can be motorised using the foot pedal.</p>

Version with three-wire cable (only available on three-phase systems)

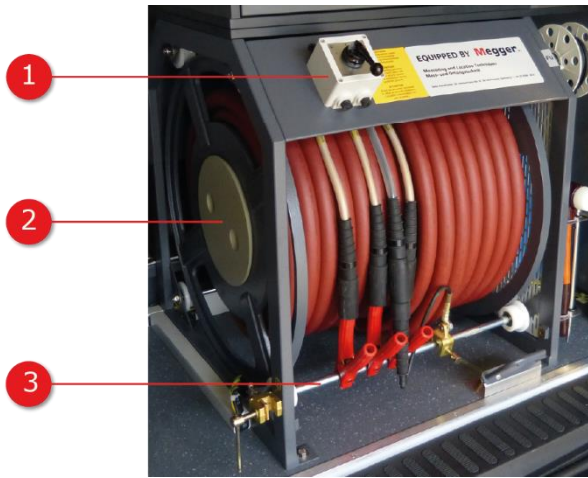

Number	Description
1	<div data-bbox="344 875 595 1167" data-label="Image"> </div> <div data-bbox="619 875 927 1077" data-label="Text"> <p>Motor control</p> <p>↑ Cable winding</p> <p>↓ Cable unwinding</p> </div>
2	<p>Storage space for the system-side end of the HV connection cable.</p> <p>The cable end must always be properly stowed in the drum body before the HV connection cable can be unwound or wound.</p>
3	<p>Earth rail for short circuit and earthing of the cable ends when the HV connection cable is not in use.</p>

6.4.1.1 Step 1: Unwinding the cable

Proceed as follows to unwind the required connection cables:

1. Ensure that the system-side end of the HV connection cable, which protrudes from the side of the cable drum, is not connected to the HV connection panel and is properly stowed in the drum body.
2. Release the brake on the cable drum.
3. Manually unwind the HV connection cable as far as necessary.
4. For three-phase systems, repeat the procedure for all other required connection cables.
Connection cables that are not needed during the current measurement must be short-circuited on the metal rail directly on the cable drum.



6.4.1.2 Step 2: Connecting to the device under test

The unwound HV connection cables must be connected to the test object using suitable connection accessories. The procedure varies depending on purpose of the measurement and the measuring accessories used.

Fault location and testing

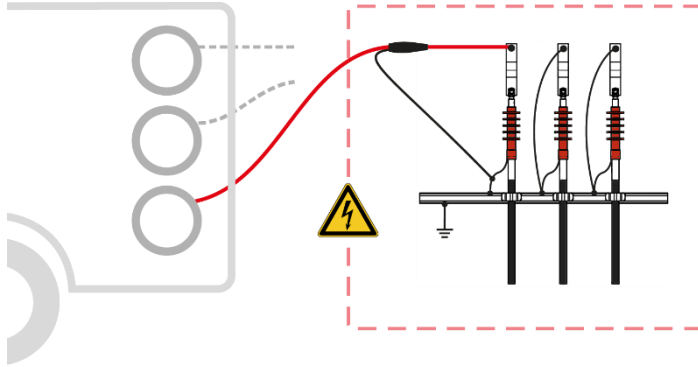

Sheath test and sheath fault pinpointing

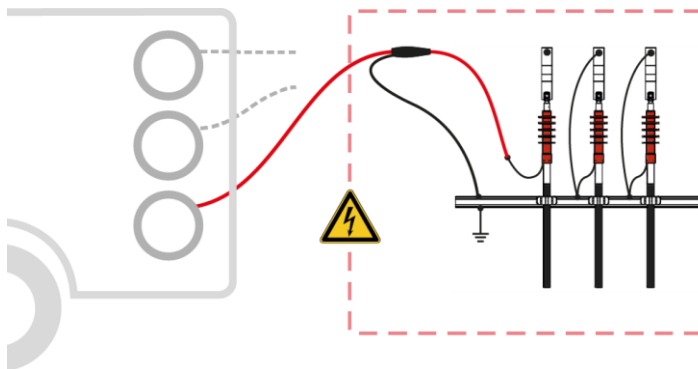

Cable shield must not be earthed at both ends of the cable!

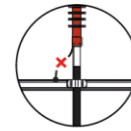

TanDelta measurements



The cable shield on the HV connection cable must be connected to the shield of the test object using the HVCC adapter supplied. A system-side connection of the adapter to the connection panel is not permitted!

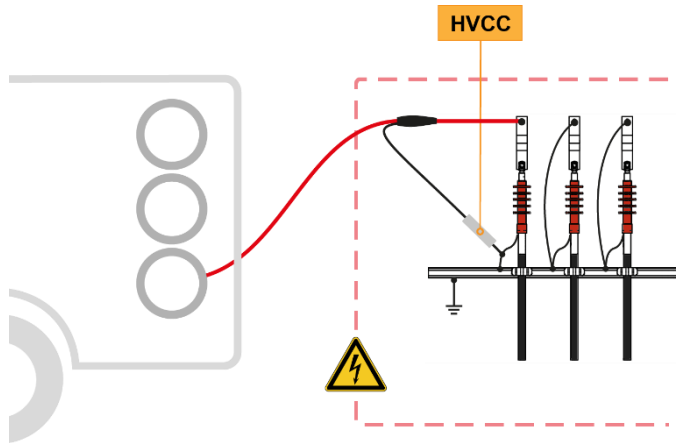

PD diagnostics with external PD coupler PDS 60 or PDS 60-HP

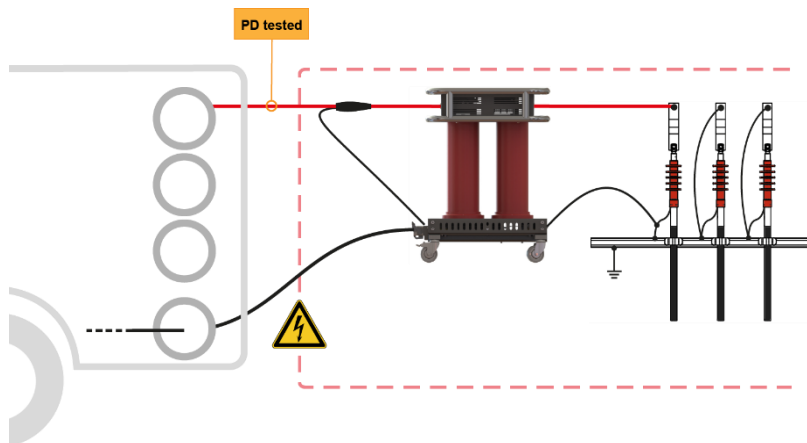

PD diagnostics with external PD coupler PDS 62-SIN

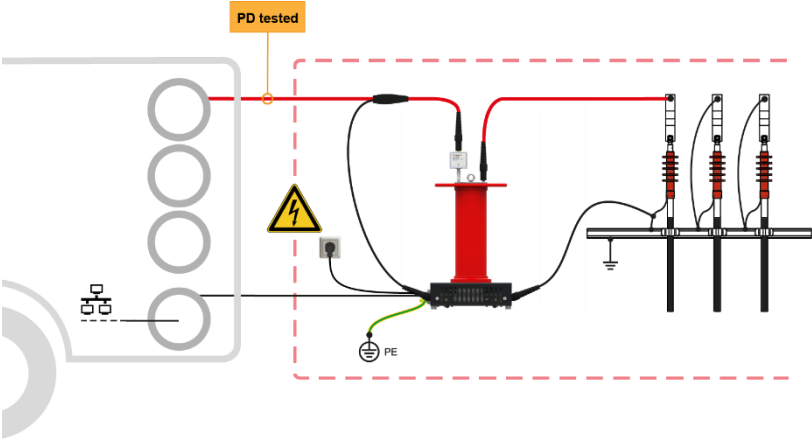

PD diagnostics with internal PD coupler PDS 60 or PDS 60-HP

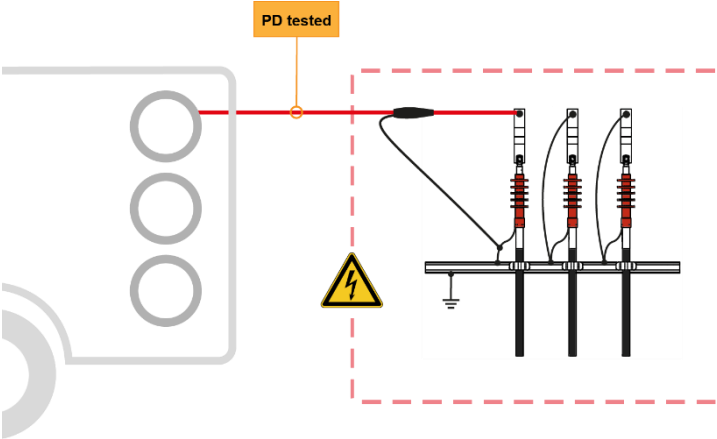

6.4.1.3 Step 3: Connecting to the appropriate HV output

On the system side, these connection cables that have been connected to the test object must be connected to the appropriate HV outputs and the associated earthing points. For three-phase systems, make sure that the numerical assignment for the connection cable and the HV output match each other. Otherwise, the measurement data will be saved with incorrect phase information.

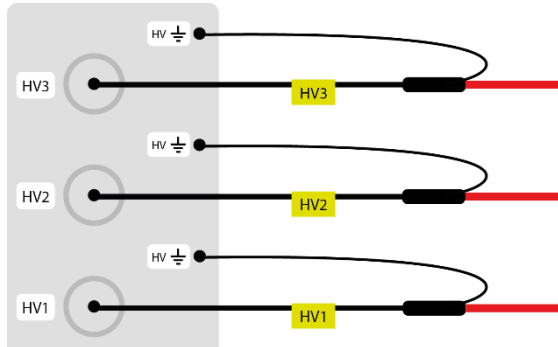

For systems that feature specific testing and diagnostics packages, a separate HV output is available for use when working in test and diagnostics modes. The type of connection for these systems varies depending on the system equipment and can be found in the sketches in the following sections.

“Basic”, “Ambition M”, “Dynamic M”, or “Ultimate M” equipment packages

- Fault location and DC test via the internal voltage source

Single-phase

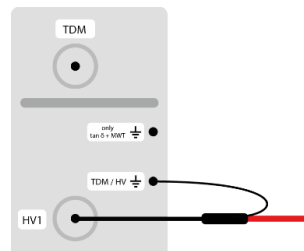

Three-phase

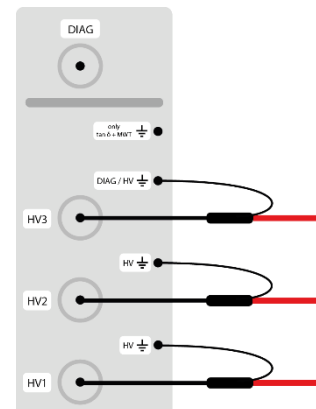

- Test using VLF test voltage (without “Three-phase testing” equipment package)
- Partial discharge diagnosis and test with accompanying partial discharge measurement (with external partial discharge coupler)

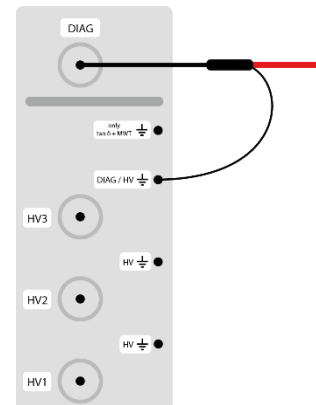
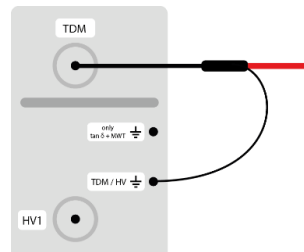

- Test using VLF test voltage (with “Three-phase testing” equipment package)

Single-phase

Three-phase

- TanDelta measurement and test with accompanying TanDelta measurement

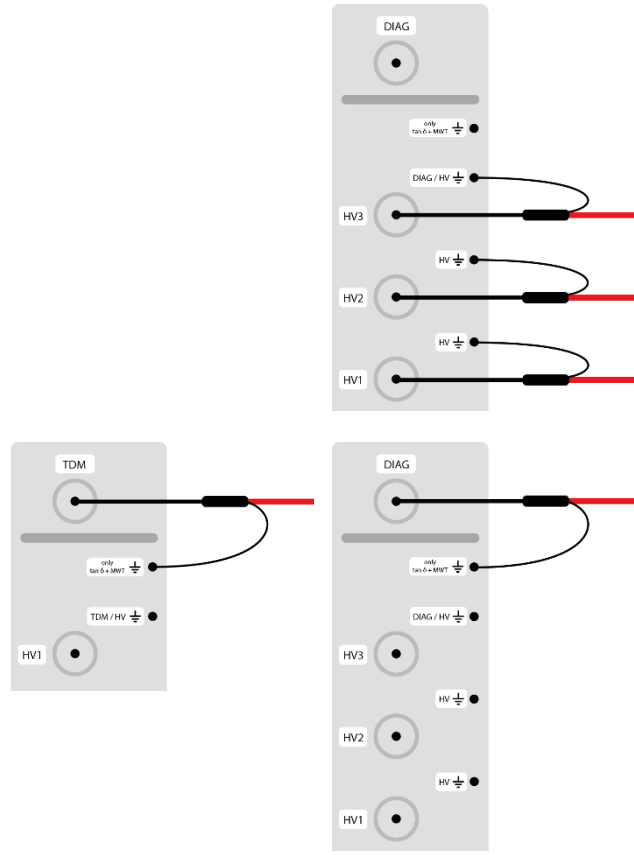

“Ambition L”, “Dynamic L”, or “Ultimate L” equipment packages

- Fault location and DC test via the internal voltage source

Single-phase

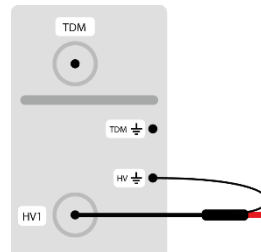

Three-phase

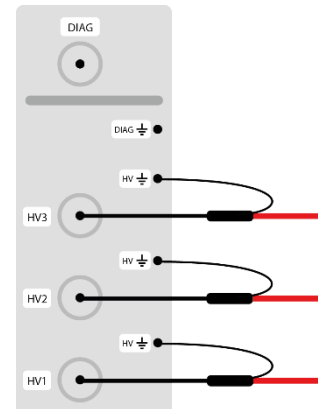

- Test using VLF test voltage (without “Three-phase testing” equipment package)
- TanDelta measurement and test with accompanying TanDelta measurement
- Partial discharge diagnosis and test with accompanying partial discharge measurement (with external partial discharge coupler)

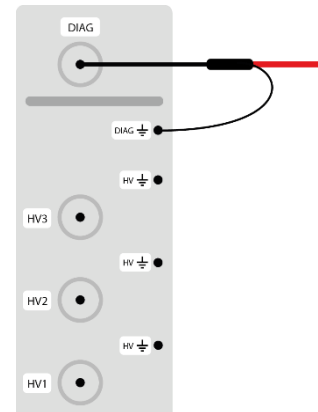
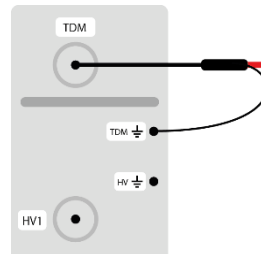

- Test using VLF test voltage (with 'Three-phase testing' equipment package)

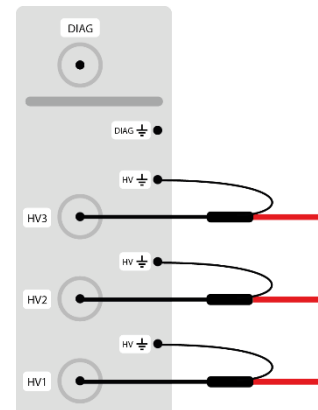

'Comfort' equipment package (internal partial discharge coupler)

For systems with an internal partial discharge coupler, the coupler must be integrated into the system-side HV path between the cable drum and the system's HV outputs for all operating modes in which a partial discharge measurement takes place.

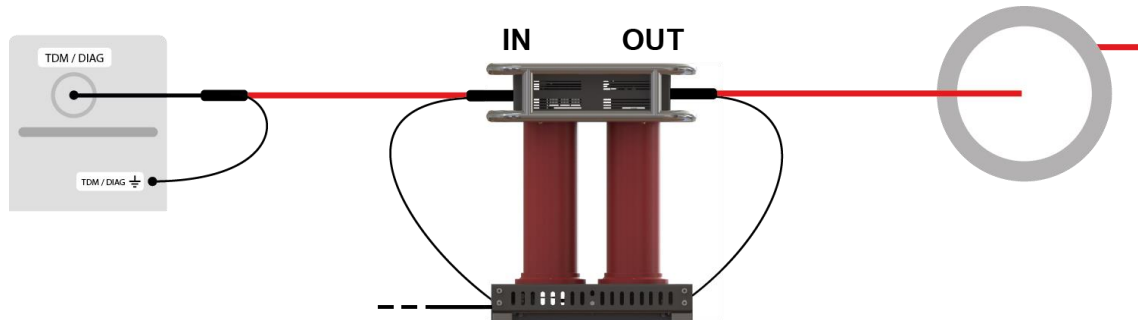

In all other operating modes, the partial discharge coupler must be disconnected from the HV path. The HV connection cable connected to the input ("IN") remains connected to the coupler and is earthed via the two parking sockets.

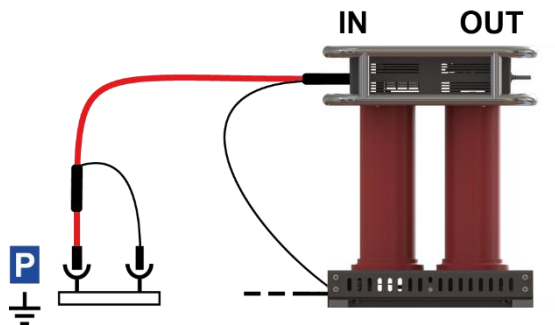

6.4.2 Using the three-phase LV connection cable (optional)

As an alternative to the HV connection cable, the optional LV coaxial cable can also be used **for TDR measurement or insulation testing with a measurement voltage of up to 1000 V**, which is easier to handle and thus enables a much faster connection. For single-phase systems, the LV cable also provides an option for three-phase measurement.

To connect the LV cable to the test object, proceed as follows:

1. If the connection cable coming from the system is connected to the socket of the cable drum body, this connection must be disconnected before the cable can be unwound.



2. Unwind the LV cable.
3. Connect the pre-assembled four-wire adapter cable for connection to the test object to the unwound LV cable.



When connecting, make sure that the four wires run as uniformly as possible to each other (ideally twisted) and that they are not separated from each other until just before the actual connection point. This ensures equal impedance ratios for all three phases.

The identification of the phases must be considered during connection to be able to correctly assign the measurement results to the respective phases.

4. Using suitable connection accessories, connect the individual phases of the LV cable to the phases of the test object and the operating earth (red terminal) to the earthed shield of the test object.
5. Reconnect the connection cable coming from the system to the socket on the cable drum.



6.4.3 Using the MFM/HVB connection cable (optional)

The special MFM/HVB connection cable is connected directly to the MFM 10 M sheath fault location system or the HVB 10 M high-voltage measuring bridge and is only used for their operating modes.



Detailed information on the connection to the test object can be found in the operating instructions of the MFM 10 M or the HVB 10 M.

6.5 Establishing the mains supply

6.5.1 Connection to mains supply



WARNING

Risk of electric shock

If the object to be measured and the mains power supply are connected to different earth systems that are not interconnected, the potential equalisation must be established using a connection cable with a cross-section of at least 16 mm² Cu while the test van is in operation. Good earthing conditions are of utmost importance here!

Proceed as follows to connect the test van to a mains power supply:

1. Release the brake on the mains cable drum.
2. Release the anti-roll latch on the outside of the cable drum housing by pulling the metal bar outward.

To lock the anti-roll latch before winding the drum back up, press on the round screw head.



3. Unwind the mains supply cable.



CAUTION

The mains cable drum must always be completely unrolled!

4. Connect the cable to a mains power outlet.



CAUTION

Only approved (VDE/IEC or corresponding national regulations) intermediate connections are to be used for the connection to mains sockets that do not fit the pre-assembled plug or for direct connection to the low-voltage cable!

Result: The two signal lamps **IN** and **OUT** on the mains connection system NAS should now light up, indicating that the input voltage is within the permissible range. If this is not the case, check the mains supply and the fuses in the NAS (see page 68).



5. Secure the cable drum brake again.

6.5.2 Operation via generator or battery power supply (optional)

If there is no possibility to tap mains power in the immediate vicinity of the deployment location, the measuring system can also be operated via an adequately dimensioned generator system or battery voltage supply.

An integrated battery power supply provided Megger automatically takes over the supply of the measuring system if the test van has not been connected to mains voltage.

The generator systems provided Megger are typically vehicle engine driven systems, which must be commissioned manually if necessary. To do this, the vehicle must be put into neutral, the generator switched on and, if necessary, the engine speed must be regulated. The exact procedure differs depending on the generator and vehicle model.

When the generator is in operation, the system automatically draws its operating voltage from the generator. This also applies if the test van is connected to the mains power supply.



For detailed information on the handling, specification and safety of the systems provided, refer to the manufacturer's product information.

6.6 Connection of the external safety device

The external safety device can be used to signal the status of the system outside the test van and to interrupt or disable the HV preparation via the emergency off switch and key switch.



Number	Description
1	The green signal lamp lights up when the system is switched on but not in high-voltage mode.
2	Safety key switch for locking the high-voltage preparation (see page 29)
3	The red signal lamp lights up as soon as high voltage can be generated. All discharge and earth devices are open and the test object is to be considered "live".
4	Emergency off switch (see page 29)

Depending on the length, the cable for connecting the external safety device is wound either on a cable drum or a wall bracket.

To open the external safety device, proceed as follows:

1. If the external safety device connection cable is provided on a cable drum, first disconnect the system from the cable drum.



2. Unroll the connection cable.
3. Place the external safety device in an accessible and visible position in the vicinity of the test van and connect the connection cable to the socket provided for this purpose.



4. If necessary, reconnect the connection cable coming from the system to the socket on the cable drum.

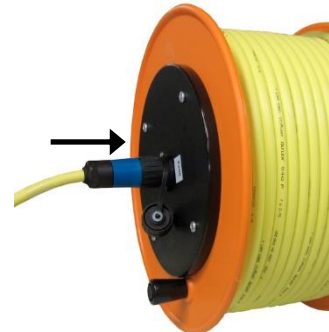

6.7 Switching on the test van

After the test van has been connected or a change has been made to the test object connection, the connection cables must be routed outwards through the cable guide as shown in the following illustration:

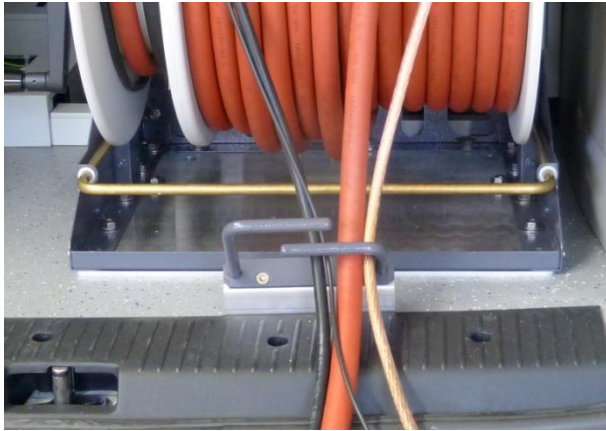

After the rear doors of the test van have been closed, it is ready to be switched on. Provided that the connection has been correctly implemented and good earthing conditions have been observed, the conditions of the safety circuit are also fulfilled.

7 Operation of the test van

7.1 Operating and display instruments in the control area

Control panel

The control panel is normally located on the partition wall between the control area and the measuring system and has the following elements.

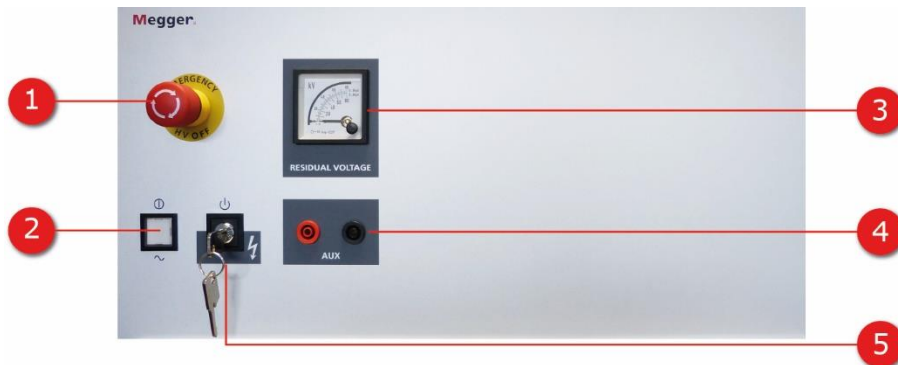

Number	Description
1	Emergency off switch (see page 29)
2	On/off button
3	Residual voltage display (see page 30)
4	External sockets (AUX) via which measurements of the connected test object phases can be taken using an external measuring device (e.g. an insulation tester). It is essential to comply with the specifications given in the technical data.
5	Safety key switch for locking the high-voltage preparation (see page 29)

Standard operating unit

As standard, the central operating unit consists of an industrial PC and a separate control pad:



Number	Description
6	Industrial PC with 21.5" multitouch screen for full operating the software
7	Ethernet port for service purposes and USB port (USB 3.0) for connecting input and output devices and storage media (see page 63). Depending on the installation situation, there may be additional remote USB ports in the area of the operating station.
8	Keyboard and mouse for operating the software and convenient data entry
9	Green 'HV On' button for enabling the high-voltage preparation
10	Red 'HV Off' button for manual shutdown of the high voltage
11	Rotary encoder with tilt function (as an alternative to multitouch operation)

Emergency operation via notebook

In the event of a failure of the operating unit, the system can be controlled with a pre-configured notebook (see page 66) provided by Megger.

7.2 Switching on

Once the test van has been set up and connected in accordance with the instructions outlined in the previous chapters, the system can be switched on by pressing the illuminated on/off button on the control panel. If the button is not lit, this indicates problems with the mains supply (see page 52).

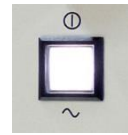

Once the industrial PC has booted up, the start screen of the operating software appears.



If the symbol  appears in the header to indicate problems that can be traced back to a faulty system connection, these problems must be remedied with the help of the following instructions:

System reports...	Cause/remedy
<ul style="list-style-type: none"> Activated emergency off switch 	<p>One of the emergency off switches (e.g. on the control panel or the external safety device) has been activated and must first be reset.</p>
<ul style="list-style-type: none"> Earth resistance too high Earth cable not connected High-voltage return conductor not connected Potential increase Fault voltage Dangerous voltage-time area 	<p>Impermissible loop resistances or voltage peaks were measured, which indicate poor earthing conditions.</p> <p>It must be checked that the following connections have been made correctly and provide good earth contact:</p> <ul style="list-style-type: none"> Earth cable Reference earth connection Cable shield of the HV connection cable
<ul style="list-style-type: none"> Rear door open 	<p>The rear door must be closed.</p>
<ul style="list-style-type: none"> Locked high voltage 	<p>The locked 'HV interlock' key switch on the control panel or the external safety device must be unlocked.</p>

7.3 Operation

The software can be operated via the touch display, the rotary knob with tilt function or mouse and keyboard.



Detailed information on operation of the software and the measuring procedures, as well as on the high-voltage release, can be found in the online help of the software.

8 Adjusting/disconnecting the electrical connection



WARNING

Risk of electric shock

- The five safety rules (see page 9) must be applied when working on the electrical connection between the test van and the test object.
- Even if the system has been properly shut down and discharged via the discharging device, the following applies: Only touch system components that have been energised if they have been discharged, earthed, and short-circuited with suitable equipment.
- Do not remove the earthing and short circuit until the test object is to be put back into operation.

Before opening the rear doors of the test van and making adjustments to the electrical connection, the following measures must be taken:

- Press the red 'HV Off' button to switch off the high voltage and initiate the discharge.
- Check the residual voltage display to ensure that the measuring circuit is de-energised.
- Ensure that there is a short circuit and earthing for the test object at the connection point.

9 Completing the work

When the measurements are complete, follow these steps to turn off the test van and disconnect the electrical connections:

1. Complete the work with the measurement and reporting software and ensure that all records required for later follow-up have either been exported or uploaded to the cloud database.



Detailed information on operation of the software can be found in the online help of the software.

2. Press the illuminated on/off button on the control panel to switch off the measuring system.

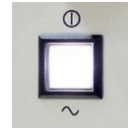

3. Verify the absence of voltage at the HV outputs using the residual voltage display (see page 30) in the control area.
4. Disconnect the electrical connections in accordance with the safety instructions (see page 61).
When disconnecting the test system, proceed in reverse sequence to the manner in which the connection was made (see page 35).
5. If the test van is equipped with a partial discharge coupler (e.g. PDS 60(-HP)), it must be short-circuited using a short-circuit cable (external coupler) or the HV connection cable connected to the input 'IN' (internal coupler) to avoid charging the integrated capacitor.

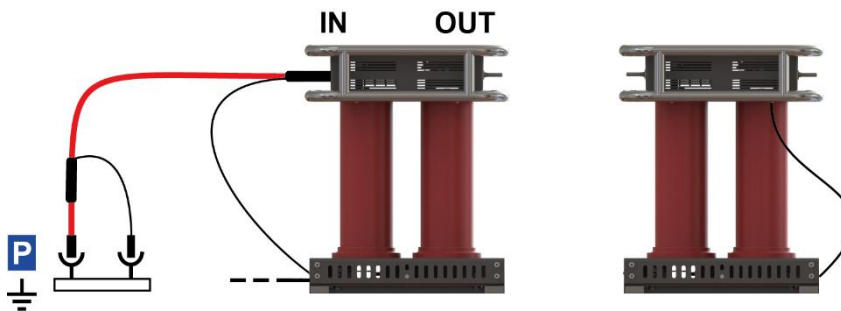

10 IT accessories and connectivity

10.1 Use of USB accessories



CAUTION

Risk of interference

To prevent malfunction of or even damage to the industrial PC, observe the following instructions:

- Do not use extension cables when connecting USB accessories.
- During HV operation, no loose USB connection cables may be inserted into the USB ports of the industrial PC.

In addition to the USB port on the industrial PC (see page 58), there are usually other USB ports available in the area of the operating station, some of which, however, may only serve as charging ports (these are marked **USB Charging**). All other USB ports are connected directly to the industrial PC and allow the following accessories to be connected:

Class	Description
Input devices	A keyboard and/or mouse can be connected for convenient data entry. It is also possible to connect a wireless keyboard and/or mouse with a suitable USB dongle.
USB mass storage	USB mass storage devices (such as USB sticks and external hard disks) can be connected for importing and exporting measurement data and reports.
Printer	A printer can be connected for direct printing of measurement data and reports. However, the selection of compatible printers is limited by the drivers installed on the system. Before purchasing a printer, please contact your Megger sales representative for a list of supported devices.

10.2 Internet and GPS connectivity (optional)

Internet and GPS connectivity are required for the availability of the following software features:

- Exchange of measurement and log data via a cloud database
- Access to online maps
- Remote control of important location and line location methods via app
- TeamViewer remote access for support and demonstration purposes
- Location indicator in the map view

The optional 4G/GPS router required for this is in most cases easily accessible on the vehicle's partition or side walls. However, with the exception of the software configuration of the router and replacement of the SIM card, no unauthorised adjustments may be made to the router and its wiring.

Inserting/swapping the SIM card

To establish a mobile data connection, there must be at least one SIM card in the router. There may also be a second slot for inserting a second SIM card available. The SIM cards must meet the following requirements:

- Format: Mini SIM
- Enabled for internet use using GPRS, EDGE, 3G or 4G (a data-only plan is sufficient)
- Providers with good network coverage



It is recommended that contracts be concluded with a fixed upper cost limit to always keep control of the costs incurred, even in the case of high data consumption!

To replace the currently installed SIM card or insert a SIM card for the first time, proceed as follows:



After the new SIM card is inserted in the orientation shown, the holder must be pushed back into the slot until it clicks into place. Following the installation of a new SIM card, the PIN of the SIM card must be stored and the configuration of the access point (APN) adjusted.





For detailed information on the software configuration of the router and the data connection, refer to the accompanying software manual or the online help of the software.

If there is a SIM card in both slots **SIM1** and **SIM2**, the data connection of the SIM card in slot **SIM1** is used until one of the following conditions occurs:

- The data volume of the SIM card in slot **SIM1** is used up.
- A data connection via the network provider of the SIM card in slot **SIM1** cannot be established.

Troubleshooting connection problems

If you experience connection problems while using the test van, the LEDs on the router may help you determine the cause of the problems. The following states are signalled:

LED	Status	Description
PWR	Off	No mains voltage available
	On	Mains voltage available
	Off	No GSM signal
	Flashing red and green alternately	No SIM card found or there are problems with the SIM cards. This may be due to the access point (APN) or SIM PIN not having been configured yet or not having been configured correctly.
	Permanently lit or flashing a single colour	Connected. When there is data traffic, the LED flashes very quickly.
		Signal strength

10.3 Emergency operation via notebook

If the industrial PC is defective, the system can also be controlled via a Windows notebook.

If a suitable notebook that has been pre-configured by Megger to suit the system was not provided directly when the test van was ordered, it can be ordered later at any time.

Connecting the notebook

To connect the notebook to the measuring system, the network cable on the underside of the industrial PC must be disconnected and connected instead to the notebook's network adapter.

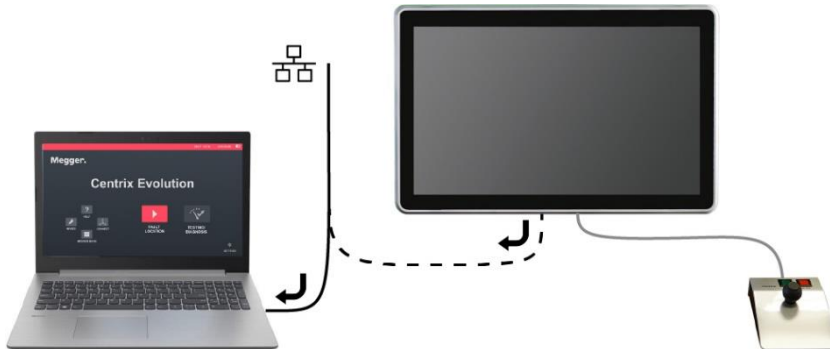

Operating instructions



WARNING

Risk of electric shock

When operating the test van using a notebook, the following information must be observed to avoid dangerous increases in voltage:

- A notebook used to control the test van must never be operated outside the test van itself!
- The notebook power supply must be connected to one of the mains sockets within the test van!
- Peripheral devices must not be connected to the notebook via cables that are located outside the test van.

After the test van has been switched on and the notebook booted up, the operating software must be started manually via the  desktop icon.

If the test van is equipped with a partial discharge measuring system, the PD measuring software starts in parallel with the actual operating software. Depending on the measurement task, it is possible to switch between the two open applications using the key combination ALT + TAB.



Detailed instructions on how to operate the PD measuring software can be found in the accompanying manual for the partial discharge measuring system.

Troubleshooting

If problems occur, they may be diagnosed and corrected using the following table:

Problem	Possible cause/remedy
After starting the software the message "Start of HV unit failed" appears	Communication with the system is disrupted. <ul style="list-style-type: none">■ Check the Ethernet connection to the system■ Check the network adapter configuration (IP address: 192.168.150.1/ subnet mask: 255.255.0.0)
After the software has been started, the message relating to the missing licence for the PD measuring software appears	It must be checked in consultation with the responsible sales partner whether the required licence activation has been carried out for the PD measuring software on the notebook.
Software does not start	Check whether an instance of the application is already active. Only one instance can run at a time.

11 Troubleshooting

11.1 Behaviour in the event of faults during normal operation

11.1.1 Check fuses

If a fault occurs, the first step is to check the test van's various circuit breakers and fuses.

If a circuit breaker or a fuse is repeatedly triggered, it must be assumed that there is a permanent fault in the affected circuit. To avoid consequential damage, further operation of the test van is not permitted.

Fuse panel below the desk in the control area:

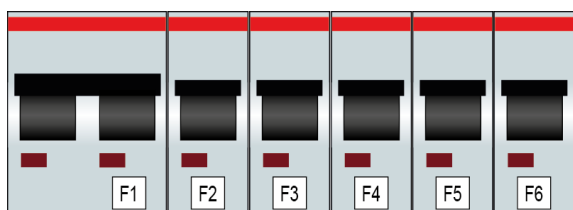

Number	Value/Type ³	Function
F1	RCD C16/0.03A	FI fuse for circuits on F4, F6, F11, F13 and F14
F2	K16A	Mains main fuse
F3	K16A	Main fuse generator
F4	C10	Air con unit fuse
F5	K16A	Switching power supply fuse and options
F6	B6	Reserve
F7	4A	TB4/24 V mains fuse
F8	4A	TB5/24 V mains fuse
F9	1A	"FU/EP" printed circuit board
F10	2A	Generator hour meter
F11	10A	Sockets (e.g. for heaters or similar)
F12	2A	Printed circuit board current measurement

³ For systems with 110 V or 120 V mains voltage, the values of individual fuses may differ from these specifications.

Number	Value/Type ³	Function
F13	10A	Sockets (desk in the control area)
F14	4A	Charger
F15	2A	TB6/24 V mains fuse (entire "On/Off button" module on the control panel)
F16	4A	Output A1: 24 V stabilised, control unit
F17	4A	Output A1: 24 V stabilised, electronics
F18	4A	Output A2: 24 V stabilised, motors

Fuses in mains supply system (NAS):

Especially in the event of power supply problems, the fuses in the mains supply system (NAS) should also be checked. This is located at the end of the mains cable.

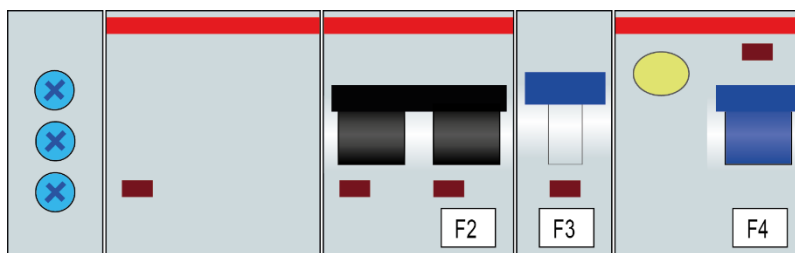

Number	Value/Type	Function
F1/F2	K16A / K32A	Main fuse power supply
F3	C2	Voltage monitoring
F4	40A, 2p, 30mA	Residual current circuit breaker
F5/F6 ⁴	T1A	Indicator lights on the NAS

Other fuses:

Some other relevant 12 or 24 V circuits (e.g. vehicle interior lighting, cable drum motor) are protected by the vehicle fuses.

⁴ Inside the housing

11.1.2 Other possible fault causes

If problems occur, they may be diagnosed and corrected using the following table:

Problem	Possible cause/remedy
<p>VLF test not possible</p> <p>When a VLF test is started, it indicates that the connected cable cannot be charged.</p>	<p>It must be checked whether all voltage converters have been disconnected from the test object.</p> <p>It is possible that a fault in the test object may also be the cause of this problem.</p>
<p>Very high PD interference levels</p> <p>In preparation for a partial discharge measurement, a very high basic interference level (>500 pC) is measured.</p>	<p>It must be checked that all earth connections are clean, have no corrosion and provide good metallic contact.</p> <p>If these measures do not achieve the desired success, a measurement from the other side is recommended.</p>
<p>Decreasing TanDelta measured values</p> <p>During a tan delta measurement, significantly decreasing tan delta measured values are detected as the voltage increases</p>	<p>This may indicate moisture in the cable or at the end caps (especially if humidity >85%).</p> <p>It is recommended to dry the end caps and clean them with a suitable cleaning agent.</p> <p>If these measures do not achieve the desired success due to climatic conditions, the measurement should be repeated when conditions have improved.</p>
<p>High PD level at the beginning of the cable</p> <p>During a partial discharge measurement, noticeably high partial discharges are measured directly at the start of the test object</p>	<p>These partial discharges could be caused by an improper type of connection.</p> <p>It is recommended to maximise the distance from earthed parts. The use of insulating mats must be avoided.</p> <p>In particular, in the case of partial discharge measurements with VLF sinusoidal voltage, corona discharges can also be the reason. This can be counteracted by appropriate field control measures such as corona rings.</p>

11.2 Behaviour in the event of continuous faults

In the event of damage, irregularities or malfunctions that cannot be rectified using the information in the operating instructions, the following steps must be carried out immediately:

1. Switch off the test van.
2. Insert a USB stick into the industrial PC's USB port.
3. Switch the system on.

Result: During a system start-up the system log file is exported to the *SystemLog* directory on the USB stick.

4. Take the test van out of operation and mark it accordingly as not functional.
5. Inform a service workshop authorised by Megger of the fault and provide the service personnel with the log file read out.

12 Care and maintenance

12.1 Testing and maintenance measures to be carried out by the operator

In order to identify potential problems at an early stage and to maintain the system in good condition, it is essential that you carry out the following tasks yourself and at appropriate intervals, depending on the usage behaviour:

- Remove dust and dirt
- Check the function of the door and emergency off switches
- Unwind the cables and check for breaks and damage
- Check the connection cables and modules of the high-voltage components for secure hold



Refer to the relevant sections in the respective operating manual for information on maintenance and care of the peripheral devices to be carried out by the operator. This especially applies to battery-powered devices.



If you notice any defects during the test, please promptly inform a service workshop authorised by Megger.

12.2 Required maintenance by a service workshop

A measuring system of the technical complexity of Centrix Evolution requires regular maintenance in order to maintain its functionality.

Measures that can be planned, such as cyclical maintenance of the test van and usage-dependent maintenance of the shock switch, are announced by system messages in the software.



The specific wording of the system messages and the respective reason for maintenance can be found in the accompanying software manual or in the online help of the software.

If such a system message occurs, a maintenance appointment must be arranged with the responsible service workshop immediately!



If the maintenance requirements are not fulfilled, the manufacturer is released from the warranty for defects shown to be due to inadequate maintenance.

Sales contact

Megger Limited
Archcliffe Road
Dover, Kent CT17 9EN
United Kingdom
T. +44 (0) 1304 502101
E. uksales@megger.com
W. uk.megger.com

Production sites

Megger Limited
Archcliffe Road
Dover, Kent CT17 9EN
United Kingdom
T. +44 (0)1 304 502101
E. uksales@megger.com

Megger Germany GmbH
Dr.-Herbert-lann-Str. 6
96148 Baunach
Germany
T. +49 (0) 9544 68 - 0
E. team.dach@megger.com

Megger Germany GmbH
Röderaue 41
01471 Radeburg
Germany
T. +49 (0) 35208 84 – 0
E. team.dach@megger.com

Megger Sweden AB
Rinkebyvägen 19
182 36 Danderyd
Sweden
T. +46 8 510 195 00
E. seinfo@megger.com

Megger Baker Instruments
4812 McMurry Ave., Suite 100
Fort Collins, CO 80525
United States
T. +1 970-282-1200
E. baker.sales@megger.com

Megger
4545 West Davis Street
Dallas, TX 75211
United States
T. +1 800-723-2861 ext. 6000
E. usasales@megger.com

The information in this document is subject to change without notice and should not be construed as a commitment by Megger Germany.

Megger Germany assumes no responsibility for any errors that may appear in this document. The company reserves the right to change the specification or design without prior notice.

Megger is a registered trademark.