



Motion accessories like transducers, mounting kits and unique adapters. Products for DRM and First trip measurements, and much more.

# Circuit breaker testing accessories

## Contents

Cables	3
DCM – DualGround	10
Software	12
Application kits	13
Static and dynamic resistance measurement	15
Transducers	18
Linear	18
Rotary	19
Transducer mounting kits	20
Universal kits	20
Circuit breaker specific kits	22
Ready-to-use kits – Rotary	25
Transducer mounting accessories	26
Other	28
Ferrites Dimensions	32
Transducer mounting examples	34

Welcome to Megger Sweden’s accessory catalog for circuit breaker products. Inside, you’ll find a wide range of accessories designed for use with products like EGIL200, EGIL, TM1700, and TM1800. Explore our latest additions, including EGIL200 accessories and new motion transducer kits.

If you have any inquiries about these accessories and their applications, don’t hesitate to reach out to us at [support.sweden@megger.com](mailto:support.sweden@megger.com). Our support team is available to assist you via email, phone, and webinars. You can also access application guides and instructional videos on [megger.com](http://megger.com) and on our YouTube channel. For instance:

EGIL200 How-to video:



DRM video:



Egil How-to video:



### Product image disclaimer.

Please note that we make every effort to ensure that our product images are as accurate as possible. However, there may be slight discrepancies between the product image and the actual product.

### Product Updates

Occasionally, We may make minor updates or changes to product design after photography has taken place.







# Cables

Item	Description	TM17/1800	EGIL200	TM1600	EGIL	Part No.
<b>Cables</b>						
Analog Input XLR/Banana	 <p>XLR3 female / 4 mm safety plugs, 1 m (3.3 ft). For customized analog transducer connection</p>	X	X	X	X	GA-00040
Cable Analog XLR/open ends	 <p>XLR3 female / open ends, 1 m (3.3 ft)</p>	X	X	X	X	GA-00041
Extension cable Analog Input	 <p>For analog input, XLR3 female / XLR3 male Analog cable EGIL/TM, 7.5 m (24.6 ft)</p>	X	X	X	X	GA-00042
Transducer cable, XLR / IP / TS	 <p>NOVOTECHNIK IP / TS, XLR3 female / M16-5 female, 1 m (3.3 ft)</p>	X	X	X	X	GA-00044
Transducer cable, XLR / TLH / LWH	 <p>NOVOTECHNIK TLH / LWH, XLR3 female / Hirschmann GDM 3009 female, 0.5 m (1.6 ft)</p>	X	X	X	X	GA-00049
Transducer cable XLR / LWG	 <p>NOVOTECHNIK LWG, XLR3 female / M12-4 female, 0.5 m (1.6 ft)</p>	X	X	X	X	GA-00050





# Cables

Item	Description	TM17/1800	EGIL200	TM1600	EGIL	Part No.
<p>Cable Current clamp</p> 	<p>For current clamp, BNC female / XLR3 female, 0.3 m (1 ft)</p>	X	X	X	X	GA-00140
<p>Cable, extension EGIL Timing MAIN</p> 	<p>Extension cable for time measurement of main contacts, XLR5 female / XLR5 male 10 m (32.8 ft)</p>			X		GA-00150
<p>Cable, EGIL Timing</p> 	<p>5 m (16.4 ft)</p> <p>Timing main, XLR5 female / 4 mm banana incl. clamps, 5 m (16.4 ft)</p>			X		GA-00155
<p>Cable, EGIL Timing AUX</p> 	<p>Timing AUX1&amp;2, XLR5 female / 4 mm banana excl. clamps, 2 m (6.5 ft)</p>			X		GA-00160
<p>Cable, EGIL Voltage sense</p> 	<p>SDRM voltage sense cable, XLR5 female / 4 mm banana, incl. clamps, 2 m (6.5 ft)</p>			X		GA-00170
<p>Cable set, Timing TM1800 AUX TM1700 AUX TM1600 MAIN TM1600 AUX EGIL200 AUX</p> 	<p>The cable sets consist of 8 cables with clamps and 4 mm stackable safety plugs. For timing of CB contacts.</p>			X	X	GA-00231
	5 m (16.4 ft)			X	X	GA-00231
	10 m (32.8 ft)			X	X	GA-00241
	15 m (49.2 ft)			X	X	GA-00251
	20 m (65.6 ft)			X	X	GA-00261
	25 m (82 ft)			X	X	GA-00271
	40 m (131 ft)			X	X	GA-00281







# Cables

Item	Description	TM17/1800	EGIL200	TM1600	EGIL	Part No.
<p>SCA600/Coax. Cable</p> 	<p>For vibration sensor, BNC male / BNC female, 10 m (32.8 ft)</p>	X		X		GA-00750
<p>Extension cable Analog input</p> 	<p>XLR3 female / XLR3 male, 1 m (3.3 ft)</p>	X	X	X	X	GA-00760
<p>Cable reel</p> 	<p>20 m (65.5 ft), 4 mm stackable safety plugs</p>					
<p>Black</p>		X	X	X	X	GA-00840
<p>Red</p>		X	X	X	X	GA-00842
<p>Yellow</p>		X	X	X	X	GA-00844
<p>Green</p>		X	X	X	X	GA-00845
<p>Blue</p>		X	X	X	X	GA-00846
<p>Cable Timing MAIN</p> 	<p>Timing M/R XLR3 male / 4 mm banana, 5 m (16.4 ft), Length of the split portion (retractable sock), 2.4 m (8 ft) to 3.8 m (12 ft)</p>	X	X			GA-00850
<p>Extension cable Timing MAIN</p> 	<p>For Timing M/R modules, XLR3 male / XLR3 female, 10 m (32.8 ft)</p>	X	X			GA-00851
<p>Timing MIR medium voltage cable</p> 	<p>3 x XLR3 male to banana, 3 m (9.8 ft) Length of the split portion, 0.5 m (1.6 ft)</p>	X	X			GA-00853





# Cables



Item	Description	TM17/1800	EGIL200	TM1600	EGIL	Part No.
<p>Timing MIR high voltage cable</p> 	<p>For 1 break/phase XLR3 male to banana, 5 m (16.4 ft) Length of the split portion (retractable sock), 2.4 m (8 ft) to 3.8 m (12.5 ft)</p>	X	X			GA-00854
<p>Adapter for Doble digital transducer</p> 	<p>For Doble digital transducer, DSUB15 male / DSUB15 female, 0.3 m (1 ft). To connect with EGIL200, adapter GA-00886 is needed.</p>	X	X			GA-00867
<p>Adapter for Siemens digital transducer</p> 	<p>For Siemens digital transducer, DSUB15 male / DIN8 female, 0.3 m (1 ft). To connect with EGIL200, adapter GA-00886 is needed.</p>	X	X			GA-00868
<p>Adapter for Vanguard digital transducer</p> 	<p>For Vanguard digital transducer, Amphenol / DSUB15 male, 0.3 m (1 ft) To connect with EGIL200, adapter GA-00886 is needed.</p>	X	X			GA-00869
<p>Timing AUX cable</p> 	<p>Two black and two red banana test leads in a common sleeve. <b>Including:</b> 4 Adapter for terminal block 4 Cable lug adapter 1 Cable, 5 m, (16.4 ft)</p>	X				GA-00870
<p>Timing AUX cable</p> 	<p>6 banana test leads in a common sleeve, 5 m (16.4 ft) Length of the split portion, 0.5 m (1.6 ft) Includes connection adapters</p>		X			GA-00871
<p>Current clamp adapter for EGIL200 Timing MIR, DRMIVDS input</p> 	<p>XLR3 male / BNC female, 0.3 m (1 ft)</p>		X			GA-00873
<p>SDRM voltage sense adapter for EGIL200 Analog input</p> 	<p>XLR3 female / XLR3 female, 0.3 m (1 ft)</p>	X				GA-00874

# Cables





Item	Description	TM17/1800	EGIL200	TM1600	EGIL	Part No.
<p><i>Digital transducer cable</i></p> 	<p>For customized digital transducer connection RS422, DSUB15 male / open ends, 10 m (33 ft)</p>	X				GA-00885
<p><i>Digital adapter cable</i></p> 	<p>Digital cable adapter EGIL200 - TM1700 / TM1800 transducer cables, neutriCON male / DSUB15 female, 0.3 m (1 ft).</p>		X			GA-00886
<p><i>Digital transducer extension cable</i></p> 	<p>Digital extension cable, old type, RS422, DSUB15 male / DSUB15 female, 10 m (33 ft)</p>	X				GA-00888
<p><i>Digital transducer cable</i></p> 	<p>For Baumer EIL rotary transducer and SIKO touchless linear transducer, old type, DSUB15 male / M12-8 female, 10 m (33 ft)</p>	X				GA-00889
<p><i>Digital transducer cable</i></p> 	<p>For Baumer EIL rotary transducer and SIKO touchless linear transducer, new type, DSUB15 male / neutriCON female, 10 m (33 ft).</p>	X				GA-00899
<p><i>Adapter for Elcon digital transducer</i></p> 	<p>For using Leine &amp; Linde 530 digital transducer, DSUB15 male / Amphenol, 10 m (33 ft)</p>	X				GA-00890

# Cables

Item	Description	TM17/1800	EGIL200	TM1600	EGIL	Part No.
<p><i>Digital transducer and extension cable</i></p> 	<p>Digital transducer cable, neutriCON female / neutriCON male, 10 m (33 ft). Also works as extension cable for GA-00899</p>	X	X			GA-00891
<p><i>Digital transducer cable</i></p> 	<p>For using Baumer BDH16.05A3600-LO-B, digital transducer, DSUB15 male / M23-12 female, 10 m (33 ft)</p>	X				GA-00895
<p><i>Ethernet cable, network</i></p> 	<p>Cable for connection to network/LAN, RJ45, 5 m (16 ft)</p>	X	X			GA-00970
<p><i>TM1700/1800/EGIL200 DCM extension cable</i></p> 	<p>1 DCM extension cable, DIN 6 male / DIN 6 female, 10 m (33 ft) Old type</p>	X				GA-00998
<p><i>Extension cable Analog Input</i></p> 	<p>1 DCM extension cable, DIN 7 male / DIN 7 female, 10 m (33 ft) Actual type. (See also kit of three DCM extension cables CG-19181)</p>	X	X			GA-00999
	<p>For analog input, XLR3 female / XLR3 male Analog cable EGIL/TM, 10 m (33 ft)</p>	X	X	X	X	GA-01005

Item	Description	TM17/1800	EGIL200	TM1600	EGIL	Part No.
<p>Cable kit Control</p> 	<p>Control cable kit, 5 banana test leads in a common sleeve Including: 5 Test clip 5 Adapter for terminal block 5 Cable lug adapter 5 5 m (16 ft) 2 0.25 m (10") 2 Jumper 1 Plastic box</p>	X	X			GA-90002
<p>HV Timing cable kit</p> 	<p>Timing M/R extension, XLR3 male / XLR3 female 5 Cables, 10 m (32.8 ft)</p>	X	X			GA-90005
<p>Connection kit for Control cables</p> 	<p>Including: 5 Test clip 5 Adapter for terminal block 5 Cable lug adapter 1 Plastic box</p>	X	X	X	X	GA-90010



# DCM – DualGround

Item	Description	TM17/1800	EGIL200	TM1600	EGIL	Part No.
<b>DCM – DualGround</b>						
<b>DCM1700</b>	DCM TM1700 DualGround™ timing					
	3- channels <b>Including:</b> 3 test cables, 11 m (35 ft) 6 clamps KD-03040	X <sup>1)</sup>				BL-59190
	6-channels <b>Including:</b> 6 test cables, 11 m (35 ft) 12 clamps KD-03040	X <sup>1)</sup>				BL-59192
<b>DCM200</b>	DCM200 DualGround™ timing Requires Software license CM-8002X					
	3- channels <b>Including:</b> 3 test cables, 11 m (35 ft) 6 clamps KD-03040		X			CM-09290
	6-channels <b>Including:</b> 6 test cables, 11 m (35 ft) 12 clamps KD-03040		X			CM-09292
<b>TM1700/1800/EGIL200 DCM Upgrade cable kit</b>	Cables for 3 channels addition DualGround™ upgrade from 3 to 6 channels Length of the 1-cable portion, 10 m (33 ft) Length of the 2-cable portion, 1.5 m (5 ft) <b>Including:</b> 3 DCM cable units 6 clamps					
			X	X		CG-19180
<b>TM1700/1800/EGIL200 DCM Extension cable kit</b>	DualGround cable, DIN 7, extension for 3 channels 10 m (33 ft), 3 x GA-00999					
		X	X			CG-19181
<b>DCM - TM1800</b>	Module for TM1800					
	DCM Module 3 DCM cables, 11 m (35 ft) DCM to Timing M/R cable 6 clamps Accessory bag					
					X <sup>2)</sup>	CG-19190
	DCM Module 6 DCM cables, 11 m (35 ft) DCM to Timing M/R cable 12 clamps Accessory bag					
					X <sup>2)</sup>	CG-19192

<sup>1)</sup> Only for TM1700

<sup>2)</sup> Only for TM1800

## DCM – DualGround





Item	Description	TM17/1800	EGIL200	TM1600	EGIL	Part No.		
DCM Span extension cable		To extend the span of the test leads when the distance between connection points is longer than 3 m (9.8 ft). BNC male / BNC female, 2 m (6.6 ft)				X	X	GA-00720
DCM Cable link		DCM to Timing M/R, DSUB9 male / 3 x XLR3 male, 0.3 m (1 ft)				X <sup>3)</sup>	GA-12900	

<sup>3)</sup> Only for TM1800

# Software

Item	Description	TM17/1800	EGIL200	TM1600	EGIL	Part No.
<b>Software</b>						
<i>CABA Win</i>						
	For TM1700/1800, incl. Ethernet cable GA-00970	X				CG-8000X
	For TM1600, incl. fiberoptics and USB interface			X		BL-8203X
	For EGIL, incl. USB cable				X	BL-8206X
	Upgrade from R04 and lower to latest version, including Test Plan Editor (TPE)	X		X	X	CG-8040X



# Application kits

Item	Description	TM17/1800	EGIL200	TM1600	EGIL	Part No.
<b>Application kits</b>						
<i>First trip kit</i>						
	<p>For single operating mechanism, 1 + 3 clamps</p> <p>For three operating mechanisms, 3 + 3 clamps</p>	X	X			BL-90700
<i>Synchro Switch Relay kit</i>						
	<p>Synchronized Switching Relay test kit incl. accessories, software and cables (delivered in transport case)</p> <p>SSR kit for TM 1700/1800</p> <p>SSR for TM1600 (incl. VD401)</p>	X				CG-91200
<i>Trig source selector</i>						
	<p>Combines signals from six trig sources into one single trig signal. Ideal when making online testing and using multiple trig sources, e.g. close command, trip command, spring charge motor, disconnecter and ground switches. Eliminates the need of reconnections between tests since all connections can be made initially.</p>	X	X	X		XB-39265
<i>Transducer calibration kit</i>						
	<p>Plate XB-39022 not included</p>	X	X	X	X	XB-39095

# Application kits

Item	Description	Part No.										
<p><i>Vibration kit</i></p> 	<p>The Vibration kit extends TM1800/TM1700/TM1600 and CABA Win with the equipment and software required for recording and analyzing vibration signals at a circuit breaker. The kit includes the signal conditioning unit SCA606, the software CABA Win Vibration and one vibration channel. The vibration solution can be extended up to 6 channels.</p>	<table border="1"> <tr> <td>TM17/1800</td> <td>EGIL200</td> <td>TM1600</td> <td>EGIL</td> <td></td> </tr> <tr> <td>X</td> <td></td> <td>X</td> <td></td> <td>BL-13090</td> </tr> </table>	TM17/1800	EGIL200	TM1600	EGIL		X		X		BL-13090
TM17/1800	EGIL200	TM1600	EGIL									
X		X		BL-13090								
<p><i>Vibration channel</i></p> 	<p>Additional vibration channel to be used together with the Vibration kit. Each Vibration channel includes accelerometer, accelerometer adapter, cables to SCA606 and cables to TM1800/TM1700/TM1600.</p>	<table border="1"> <tr> <td>TM17/1800</td> <td>EGIL200</td> <td>TM1600</td> <td>EGIL</td> <td></td> </tr> <tr> <td>X</td> <td></td> <td>X</td> <td></td> <td>XB-32010</td> </tr> </table>	TM17/1800	EGIL200	TM1600	EGIL		X		X		XB-32010
TM17/1800	EGIL200	TM1600	EGIL									
X		X		XB-32010								





# Static and dynamic resistance measurement

Item	Description	TM17/1800	EGIL200	TM1600	EGIL	Part No.		
<b>Static and dynamic resistance measurement</b>								
SDRM201 EGIL	 <p>GB-03431</p>	<p><i>Included accessories:</i></p> <ul style="list-style-type: none"> <li>SDRM Cable for EGIL GB-03431</li> <li>SDRM multi cable extension, 10 m (33 ft) GA-12812</li> <li>Voltage sense KG-00175</li> <li>Voltage sense extension cable GA-00150</li> <li>Current cable (red) GA-12824</li> <li>Current cable (black) GA-12834</li> <li>Clamps (2 pcs) KD-03040</li> <li>Ground cable, 2.5 mm<sup>2</sup>, 10 m (33 ft) GA-00208</li> <li>Charger HC-04210</li> <li>Accessory bag GD-31040</li> <li>Case GD-00222</li> </ul>				X	CG-90250	
SDRM201 TM1700/TM1800/ EGIL200	 <p>GB-03412</p>	<p><i>Included accessories:</i></p> <ul style="list-style-type: none"> <li>SDRM Cable for TM1700/1800/EGIL200 GB-03412</li> <li>SDRM multi cable extension, 10 m (33 ft) GA-12812</li> <li>Current cable (red) GA-12824</li> <li>Current cable (black) GA-12834</li> <li>Ground cable, 2.5 mm<sup>2</sup>, 10 m (33 ft) GA-00208</li> <li>Charger HC-04210</li> <li>Accessory bag GD-31040</li> <li>Case GD-00222</li> </ul>				X	X	CG-90260
CG-90235	 <p>CG-90235</p>	<p>Pack of 3 units (CG-90260) for circuit breaker with 1 Break/Phase Includes 3-phase SDRM cable, CG-90235</p>				X	X	CG-90263



# Static and dynamic resistance measurement

Item	Description	TM17/1800	EGIL200	TM1600	EGIL	Part No.
<p>SDRM202 EGIL</p> 	<p><i>Included accessories</i></p> <ul style="list-style-type: none"> <li>SDRM Cable for EGIL GB-03431</li> <li>SDRM multi cable extension, 10 m (33 ft) GA-12812</li> <li>Voltage sense KG-00175</li> <li>Voltage sense extension cable GA-00150</li> <li>Current cable (red) GA-12824</li> <li>Current cable (black) GA-12834</li> <li>Clamps (2 pcs) KD-03040</li> <li>Ground cable, 2.5 mm<sup>2</sup>, 10 m (33 ft) GA-00208</li> <li>Charger HC-04210</li> <li>Accessory bag GD-31040</li> <li>Case GD-00222</li> </ul>					X CG-90220
<p>SDRM202 TM1700/TM1800/ EGIL200</p>  <p style="text-align: right;">GB-03412</p>	<p><i>Included accessories</i></p> <ul style="list-style-type: none"> <li>SDRM Cable for TM1700/1800 GB-03412</li> <li>SDRM multi cable extension, 10 m (33 ft) GA-12812</li> <li>Current cable, red, 2 pcs, 3 m (9.8 ft) GA-12824</li> <li>Current cable, black 2 pcs, 0.5 m (1.6 ft) GA-12834</li> <li>Ground cable, 2.5 mm<sup>2</sup> 10 m (33 ft) GA-00208</li> <li>Charger HC-04210</li> <li>Accessory bag GD-31040</li> <li>Case GD-00222</li> </ul>	X	X			CG-90200
 <p style="text-align: right;">CG-90235</p>	<p>Pack of 3 units (CG-90200) for circuit breaker with 2 Breaks/Phase Includes 3-phase SDRM cable, CG-90235.</p>	X	X			CG-90230

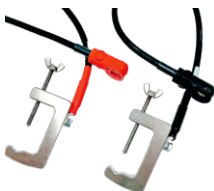

# Static and dynamic resistance measurement

Item	Description	TM17/1800	EGIL200	TM1600	EGIL	Part No.
SDRM201/202 Cable						
 <p>GB-03412</p>	<p><b>Including:</b>            SDRM Cable for TM1700/1800/EGIL200 GB-03412            Accessory bag GD-31040</p>	X	X			CG-90205
 <p>GB-03431</p>	<p><b>Including:</b>            SDRM Cable for EGIL GB-03431            Voltage sense extension cable 10 m (33 ft) GA-00150            Accessory bag GD-31040            Voltage sense cable, 2 m (6.5 ft) KG-00175            Clamps 2 pcs KD-03040</p>				X	CG-90225
SDRM201/202 3-phase SDRM Cable						
	<p>For 3-phase measurement at 1 or 2 breaks/phase with TM1700/TM1800/EGIL200            Simplifies connections when using three SDRM201 or SDRM202 units together  <b>Including:</b>            3-phase SDRM Cable GB-03460            Power supply HC-04212            Accessory bag GD-31040</p>	X	X			CG-90235
Extension cable, SDRM201/202						
	<p>Extension cable for:            CG-90200, CG-90220, CG-90250 and CG-90260            10 m (33 ft)</p>	X	X		X	GA-12812
SDRM201/202 Current cables and clamps						
	<p>For wing nut binding posts.            Cable, red 3 m (9.8 ft)</p>	X	X	X	X	GA-12820
	<p>Cable, black, 0.5 m (1.6 ft)</p>	X	X	X	X	GA-12830
	<p>For quick connectors            Cable, red 3 m (9.8 ft)</p>	X	X		X	GA-12824
	<p>Cable, black, 0.5 m (1.6 ft)</p>	X	X		X	GA-12834





# Transducers

Item	Description	TM17/1800	EGIL200	TM1600	EGIL	Part No.
<b>Transducers</b>						
<b>Linear</b>						
<b>Analog</b>						
<i>TLH-150</i>	150 mm (5.9") travel <sup>1)</sup>	X	X	X	X	XB-30016
<i>TLH-225</i>	225 mm (8.8") travel <sup>1)</sup>	X	X	X	X	XB-30017
<i>TLH-500</i>	500 mm (19.7") travel <sup>1)</sup>	X	X	X	X	XB-30020
<i>TLH-750</i>	750 mm (29.5") travel <sup>1)</sup>	X	X	X	X	XB-30022
<i>TLH-1000</i>	1000 mm (39.4") travel <sup>1)</sup>	X	X	X	X	XB-30023
	<sup>1)</sup> Including cable, 0.5 m (20")					GA-00049
<i>LWG 150</i>	150 mm (5.9") travel <sup>2)</sup>	X	X	X	X	XB-30116
<i>LWG 225</i>	225 mm (8.8") travel <sup>2)</sup>	X	X	X	X	XB-30117
<i>LWG 500</i>	500 mm (19.7") travel <sup>2)</sup>	X	X	X	X	XB-30120
	<sup>2)</sup> Including cable, 0.5 m (20")					GA-00050
<i>TS 150</i>	150 mm (5.9") travel <sup>3)</sup>	X	X	X	X	XB-30030
<i>TS 50</i>	50 mm (1.9") travel <sup>3)</sup>	X	X	X	X	XB-30031
<i>TS 25</i>	25 mm (1") travel <sup>3)</sup>	X	X	X	X	XB-30033
	<sup>3)</sup> Including cable, 1 m (39")					GA-00044
The above transducers are also available in other lengths, please contact Megger for more information.						
<b>Touchless linear digital transducer (kit)</b>						
	<b>Including:</b> Magnetic band, 2 m (6 ft) XB-39250 Touchless linear digital transducer, SIKO XB-39238 Cable, 10 m (33 ft) GA-00899 Clamping base XB-39014 Flexible arm XB-39021	X				XB-39230
	<b>Including:</b> Magnetic band, 2 m (6 ft) XB-39250 Touchless linear digital transducer, SIKO XB-39238 Cable, 10 m (33 ft) GA-00891 Clamping base XB-39014 Flexible arm XB-39021		X			XB-39231

# Transducers

Item	Description	TM17/1800	EGIL200	TM1600	EGIL	Part No.
<b>Rotary</b>						
<b>Analog</b>						
<i>Transducer kit</i>						
	Novotechnik IP6501 <b>Including:</b> Cable, 1 m (39"), Flex coupling, 6 mm Hexagon wrench	X	X	X	X	XB-31010
<b>Digital</b>						
<i>Transducer kit</i>						
	Baumer EIL580-SC10.5RH.03600.A <b>Including:</b> Flex coupling, 10/6 mm Hexagon wrench Cable GA-00899, DSUB15 male / neutriCON female, 10 m (33 ft)	X				XB-39130
	Baumer EIL580-SC10.5RH.03600.A <b>Including:</b> Flex coupling, 10/6 mm Hexagon wrench Cable GA-00891, neutriCON male / neutriCON female, 10 m (33 ft)		X			XB-39131





# Transducer mounting kits

Item	Description	TM17/1800	EGIL200	TM1600	EGIL	Part No.
<b>Transducer mounting kits</b>						
<b>Universal kits</b>						
<b>Transducer kit 500/600 mm</b>	 <p>Typically suited for bulk oil circuit breakers.  <b>Including:</b>            Transducer TLH-500            Transducer adapter cable 0.5 m (GA-00049)            L-shaped mounting bracket            Pull rod 850 mm with UNF 10/32 threads            Transducer/rod clamp            Welding clamp            Transport case            Single phase, Analog, Linear, 500 mm (19.7")</p>	X	X	X	X	XB-40101
	<p>Same as XB-40101 but with transducer TLH-600.            Single phase, Analog, Linear, 600 mm (23.6")</p>	X	X	X	X	XB-40102
<b>Transducer kit 300 mm</b>	 <p>Typically suited for SF6 dead tank and bulk oil circuit breakers.  <b>Including:</b>            Transducer TLH-300            Transducer adapter cable 0.5 m (GA-00049)            L-shaped mounting bracket            Pull rods 250 mm and 500 mm with UNF 10/32 and UNC 1/4 20 threads            Transducer/rod clamp            Welding clamp            Transport case            Single phase, Analog, Linear, 300 mm (11.8")</p>	X	X	X	X	XB-40103
<b>Transducer kit 300 mm</b>	 <p>Same as XB-40103, but with three of each item.            3 phase, Analog, Linear, 300 mm (11.8")</p>	X	X	X		XB-40104

# Transducer mounting kits

Item	Description	TM17/1800	EGIL200	TM1600	EGIL	Part No.	
<b>Transducer mounting kits</b> <i>Note: Transducers not included</i>		Same as XB-40101 and XB-40102 but without transducers.	X	X	X	X	XB-40110
		Same as XB-40103 but without transducers.	X	X	X	X	XB-40111
		Same as XB-40104 but without transducers.	X	X	X		XB-40112
<b>Rotary transducer mounting kit</b>	 <p data-bbox="675 792 1150 819">For transducers XB-31010, XB-39130 and XB-39131</p> <p data-bbox="675 819 778 846"><b>Including:</b></p> <ul style="list-style-type: none"> <li data-bbox="675 846 1198 873">Clamping base XB-39014</li> <li data-bbox="675 873 1198 900">Flexible arm XB-39021</li> <li data-bbox="675 900 1198 927">Holder for analog rotary transducer Ø 55 mm XB-39022</li> <li data-bbox="675 927 1198 954">Plastic transport case XB-39023</li> <li data-bbox="675 954 1198 981">Adapter M6/6 2 Nuts M6 XB-39025</li> <li data-bbox="675 981 1198 1008">Adapter M8/6 2 Nuts M8 XB-39026</li> <li data-bbox="675 1008 1198 1034">Adapter M10/6 2 Nuts M10 XB-39027</li> <li data-bbox="675 1034 1198 1061">Adapter M12/6 2 Nuts M12 XB-39028</li> <li data-bbox="675 1061 1198 1099">Holder for dig. rotary EIL and linear LWG, Ø 36 mm XB-39005</li> </ul>	X	X	X	X	XB-51010	
<b>Universal transducer mounting kit</b>	 <p data-bbox="675 1115 975 1142">For linear and rotary transducers</p> <p data-bbox="675 1142 778 1169"><b>Including:</b></p> <ul style="list-style-type: none"> <li data-bbox="675 1169 1198 1196">Magnetic base XB-39013</li> <li data-bbox="675 1196 1198 1223">Clamping base XB-39014</li> <li data-bbox="675 1223 1198 1249">Flexible arm XB-39021</li> <li data-bbox="675 1249 1198 1276">Holder for analog rotary transducer Ø 55 mm XB-39022</li> <li data-bbox="675 1276 1198 1303">Plastic transport case XB-39023</li> <li data-bbox="675 1303 1198 1330">Adapter M6/6 2 Nuts M6 XB-39025</li> <li data-bbox="675 1330 1198 1357">Adapter M8/6 2 Nuts M8 XB-39026</li> <li data-bbox="675 1357 1198 1384">Adapter M10/6 2 Nuts M10 XB-39027</li> <li data-bbox="675 1384 1198 1411">Adapter M12/6 2 Nuts M12 XB-39028</li> <li data-bbox="675 1411 1198 1438">Universal support XB-39029</li> <li data-bbox="675 1438 1198 1480">Holder for dig. rotary EIL and linear LWG, Ø 36 mm XB-39005</li> </ul>	X	X	X	X	XB-51020	
<b>Universal adapter for rotary transducer</b>	 <p data-bbox="675 1809 1222 1859">Universal adapter to breaker and drive types HPL, LTB, BLG, 8DN9, 8DN8, 3AP1FG, 3AQ, 3DP3, 3AP1FI</p>	X	X	X	X	XB-51060	



# Circuit breaker specific kits

Item	Description	TM17/1800	EGIL200	TM1600	EGIL	Part No.	
<b>Circuit breaker specific kits</b>							
<i>LTB Kit ABB / Hitachi</i>		<b>Including:</b> Mounting kit, XB-51010 Universal adapter for rotary transducer XB-51060	X	X	X	X	XB-61010
<i>VD4 Adapter ABB</i>		Fits with TS-transducer, Stainless steel	X	X	X	X	GB-39030
<i>HPL/BLG Kit ABB / Hitachi</i>		<b>Including:</b> Mounting kit XB-51010 Universal adapter for rotary transducer XB-51060	X	X	X	X	XB-61020
<i>ELF-HKA/AHMA Kit ABB / Hitachi</i>		3-phase diagnostic set for ABB / Hitachi drive mechanism type AHMA 4/8 <b>Including:</b> 3 Transducers 3 Adapter cable Mounting details Transport case Calibration certificates	GA-00044	X	X	X	XB-61030



## Circuit breaker specific kits

Item	Description	TM17/1800	EGIL200	TM1600	EGIL	Part No.
<p>ELF-HKA/AHMA ABB / Hitachi</p> 	<p>1-phase diagnostic set for ABB drive mechanism type AHMA 4/8  <b>Including:</b>            Transducer            Adapter cable            Mounting details            Transport case            Calibration certificates</p> <p style="text-align: right;">GA-00044</p>	X	X	X	X	XB-61050
<p>HMB Kit ABB / Hitachi</p> 	<p>3-phase diagnostic set for ABB / Hitachi drive mechanism type HMB 4/8  <b>Including:</b>            3 Transducers            3 Adapter cable            1 Transport case            3 Calibration Certificates</p> <p style="text-align: right;">GA-00044</p>	X	X	X		XB-61040
<p>HMB Kit ABB / Hitachi</p> 	<p>1-phase diagnostic set for ABB / Hitachi drive mechanism type HMB 4/8  <b>Including:</b>            Transducer            Adapter cable, GA-00044            Transport case            Calibration Certificate</p>	X	X	X	X	XB-61060
<p>HMC kit ABB / Hitachi</p> 	<p>1-phase diagnostic set for ABB / Hitachi drive mechanism type HMC  <b>Including:</b>            Transducer            Adapter cable, GA-00044            Transport case            Calibration certificate</p>	X	X	X	X	XB-61065

# Circuit breaker specific kits

Item	Description	TM17/1800	EGIL200	TM1600	EGIL	Part No.
GL314-GL318 (GE) ABB / Hitachi: ELK-04	 <p>1-phase diagnostic set for below listed breakers:  <b>General Electric:</b> GL314(X), GL315(X)[D], GL316(X)[D], GL317(X)[D], GL318(X)[D], all with FK3-XX mechanism  <b>ABB / Hitachi:</b> ELK-04</p> <p><b>Including:</b>            Digital transducer that can be arranged as a slim rotary transducer, depth: 25 mm (1")            Digital transducer cable, GA-00891, 10 m (33 ft)            Flexible arm, XB-39021            Clamping base, XB-39014            Transport case            Assembling tools</p>	X	X	X	X	XB-39276
	3-phase diagnostic set Same as XB-39276 but with three of each item	X	X	X	X	XB-39274
 <p>1-phase diagnostic set for below listed breakers:  <b>General Electric:</b> GL314(X), GL315(X)[D], GL316(X)[D], GL317(X)[D], GL318(X)[D], all with FK3-XX mechanism  <b>ABB / Hitachi:</b> ELK-04</p> <p><b>Including:</b>            Digital transducer that can be arranged as a slim rotary transducer, depth: 25 mm (1")            Digital transducer cable, GA-00899, 10 m (33 ft)            Flexible arm, XB-39021            Clamping base, XB-39014            Transport case            Assembling tools</p>	X	X	X	X	XB-39272	
	3-phase diagnostic set Same as XB-39272 but with three of each item.	X	X	X	X	XB-39270

# Circuit breaker specific kits

Item	Description	TM17/1800	EGIL200	TM1600	EGIL	Part No.
<b>Ready-to-use kits – Rotary</b>						
<b>Analog</b>						
1-phase kit	 <p>Incl. transducer XB-31010, mounting kit XB-51010</p>	X	X	X	X	XB-71010
3-phase kit	Incl. 3 x 1-phase kits XB-71010	X	X	X		XB-71013
<b>Digital</b>						
1-phase kit	 <p><b>Including:</b> Transducer XB-39130 Mounting kit XB-51010 With Cable, 10 m (33 ft)</p>	X				XB-71020
3-phase kit	<b>Including:</b> 3 x 1-phase kits XB-71020	X				XB-71023
1-phase kit	 <p><b>Including:</b> Transducer XB-39131 Mounting kit XB-51010 With Cable, 10 m (33 ft)</p>	X				XB-71026
3-phase kit	<b>Including:</b> 3 x 1-phase kits XB-71026	X				XB-71027

# Circuit breaker specific kits

Item	Description	TM17/1800	EGIL200	TM1600	EGIL	Part No.
<b>Transducer mounting accessories</b>						
Holder for transducer 	Holder for dig. rotary Baumer EIL and linear LWG, Ø 36 mm	X	X	X	X	XB-39005
Switch magnetic base 	For easy attachment of transducer mounting arrangements. Equipped with threaded hole suited for a "Flexible arm".	X	X	X	X	XB-39013
Clamping base 	Clamp suited for a "Flexible arm" Jaw opening max 40 mm	X	X	X	X	XB-39014
Flexible arm 	M8 bolt threads at the ends of the arms	X	X	X	X	XB-39021
Holder for transducer 	Holder for rotary transducers: Novotechnik IP6501 analog and Baumer BDH digital, Ø 55 mm	X	X	X	X	XB-39022
Universal support 	Suited for the "Flexible arms". Rod length is 250 mm Jaw opening max 40 mm	X	X	X	X	XB-39029
Flex coupling 	For shaft diam. 6 mm (for Novotechnik IP6501)	X	X	X	X	XB-39030
Flex coupling 	For shaft diam. 10 / 6 mm (for Baumer BDH and EIL)	X	X	X	X	XB-39032

Item	Description	TM17/1800	EGIL200	TM1600	EGIL	Part No.
Thread adapter kit	 <p>Imperial / metrics adapter kit for TLH  <b>Including:</b>            1 nut metrics, M5            1 spacer nut, M5 / UNF 10-32            1 spacer nut, M5 / UNC 1/4-20            1 nut, UNF 10-32            1 nut, UNC 1/4-20</p>	X	X	X	X	XB-39036
Magnetic adapter for motion transducer fitting.	 <p>For attaching rotary transducers on shaft ends.            Ideal at first trip test when other mechanical attachment methods are impracticable.            Fits to a Ø 6 mm flex coupling.            Super strong neodymium magnet.            Fits with both resistive and incremental rotary transducers</p>	X	X	X	X	XB-39037
Holder for TS transducer	 <p>For TS Transducer 18 mm</p>	X	X	X	X	XB-39512

Item	Description	TM17/1800	EGIL200	TM1600	EGIL	Part No.
<b>Other</b>						
<i>Dolphin clamps</i>						
	Black, with connection for 4 mm banana plug	X	X	X	X	40-08320
						
	Red, with connection for 4 mm banana plug	X	X	X	X	40-08322
<i>Timing clamp</i>						
	Timing clamp for bolt head	X	X	X	X	53-31800
<i>Cable organizer</i>						
	Hook-and-loop straps, 10 pcs.	X	X	X	X	AA-00100
<i>VD401</i>						
	Voltage divider, ratio 400/1 (for TM1600 and EGIL with analog channel)			X	X	BL-90070
<i>USB to fiber adapter</i>						
	CABA Hardware USB to fiber adapter			X		BL-90165
<i>Current clamp</i>						
	AC/DC current clamp, 10 A, 100 mV / A, 100 A, 10 mV / A. Incl. BNC to XLR adapter GA-00140	X	X	X	X	BL-90600
	Pack of three BL-90600	X	X	X	X	BL-90610
<i>Current clamp for static resistance measurement on GIS circuit breakers with DualGround</i>						
	AC/DC current clamp S.C 200/1, 5 mV / A	X				XA-12992

Item	Description	TM17/1800	EGIL200	TM1600	EGIL	Part No.
Multi purpose current clamps	 <p>Current Probe 30A DC/AC 100 mV/A 100 kHz Recommended accessory, BNC to XLR adapter (GA-00140)</p>	X	X	X	X	XA-11000
Multi purpose current clamps	 <p>Current Probe 30/300A DC/AC 10/1 mV/A 20 kHz Recommended accessory, BNC to XLR adapter (GA-00140)</p>	X	X	X	X	XA-11620
Breaker Simulator BRS503	 <p>Breaker simulator incl. power supply 24 V/1 A. For product training and demo purpose. Runs together with all Megger circuit breaker analyzers. Pedagogic design 1 break / phase, Main and PIR contacts Two Auxiliary contacts Analog and Digital motion outputs Breaker status indication Realistic coil currents Connection guide included</p>	X	X	X	X	BL-97390
Temperature sensor	 <p>With the temperature sensor the ambient temperature is automatically recorded with each measurement and stored together with the test result. The temperature becomes a parameter in CABA Win. Suitable cable is the Analog cable, 10 m (GA-01005). Range: -20°C to +50°C (-4°F to +122°F) Resolution: 0.5°C (0.9°F)</p>	X <sup>4)</sup>				CG-90070
Thermopaper	 <p>114 mm, 30 m</p>		X	X	X	GC-00100
Thermopaper	 <p>Box/24 pcs</p>		X	X	X	GC-00140
Thermopaper	 <p>114 mm, Ø 40 mm</p>	X <sup>5)</sup>				GC-00110
Soft case	 <p>Made from sturdy nylon fabric</p>	X				GD-00315
Cable and accessories bag	 <p>With backpack straps and hand straps. Variable height through zipper solution. Dimensions 580x355x165/228 mm (23" x 14" x 6.5/9")</p>	X	X	X	X	2012-180

<sup>4)</sup> Only for TM1800

<sup>5)</sup> Only for TM1800

Item	Description	TM17/1800	EGIL200	TM1600	EGIL	Part No.
Cable case	 <p>Cable case soft with 11 compartments With shoulder strap and two handles Made from sturdy nylon fabric Dimensions: 740 x 270 x 420 mm <b>Note:</b> No cables included</p>	X	X	X	X	GD-31055
Clamp		X	X	X	X	KD-03040
Clamps	 <p>Multipurpose kelvin clamp for timing and low resistance measurement, black, 4 mm banana socket.</p>  <p>Multipurpose kelvin clamp for timing and low resistance measurement, red, 4 mm banana socket.</p>	X	X	X	X	XB-39300
Ferrite kit, clip-on, with protective cover	 <p>Accessory for timing of GIS circuit breakers using TM1800, TM1700, EGIL200 with DualGround™ <b>Including:</b> C-shape ferrite clip with clips 4 XB-40040 C-shape ferrite 4 XB-40050 I-shape ferrite 4 XB-40060 Round ferrite 4 30-67090 Transport case GD-00440 User Guide ZP-CG04E</p>	X	X			XB-39590
Ferrite C-shape, protective cover, clips	 <p>Width: 37.5 mm (1.5")</p>	X	X			XB-40040
Ferrite C-shape, protective cover	 <p>Width: 37.5 mm (1.5")</p>	X	X			XB-40050
Ferrite I-shape, protective cover	 <p>Width: 37.5 mm (1.5")</p>	X	X			XB-40060
Ferrite kit, Velcro attachment, w/o protective cover	 <p>Accessory for timing of GIS circuit breakers using TM1800, TM1700, EGIL200 with DualGround™ <b>Including:</b> C-shape ferrite 7 XB-40010 I-shape ferrite 4 XB-40020 Round ferrite 4 30-67090 Hook and loop fastener 4 09-10140 Transport case GD-00440 User's Manual ZP-CG04E</p>	X	X			XB-40090

Item	Description	TM17/1800	EGIL200	TM1600	EGIL	Part No.
<p>Ferrite kit with slim I-shape ferrites, Velcro attachment, w/o protective cover</p> 	<p>Accessory for timing of GIS circuit breakers using TM1800, TM1700, EGIL200 with DualGround™</p> <p><b>Including:</b></p> <ul style="list-style-type: none"> <li>C-shape ferrite 7 XB-40010</li> <li>I-shape slim ferrite (w. 25mm) 4 XB-40030</li> <li>Round ferrite 4 30-67090</li> <li>Hook and loop fastener 4 09-10140</li> <li>Transport case GD-00440</li> <li>User's Manual ZP-CG04E</li> </ul>	X	X			XB-40095
<p>Ferrite I-shape slim</p> 	<p>Width: 25 mm</p>	X	X			XB-40030
<p>C-shape ferrite</p> 	<p>Width</p>	X	X			XB-40010
<p>I-shape ferrite</p> 	<p>Width</p>	X	X			XB-40020
<p>Round ferrite</p> 	<p>Width</p>	X	X			30-67090

## Ferrites Dimensions

### C-shape ferrite

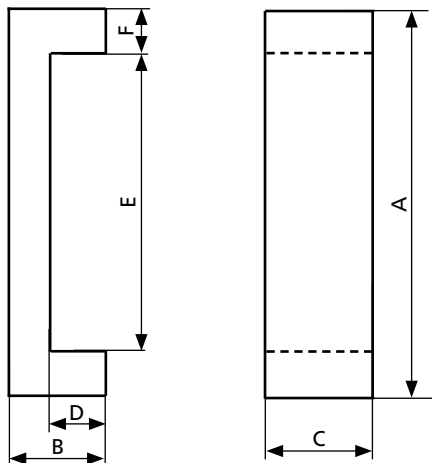

- A 102 mm (4.0")
- B 20.5 mm (0.8")
- C 37.5 mm (1.5")
- D 13 mm (0.5")
- E 85 mm (3.3")
- F 8 mm (0.3")

Note: Measures does not include hook and loop fastener

### I-shape ferrites

Two versions, one included in the Ferrite kit and a slimmer one as an optional accessory.

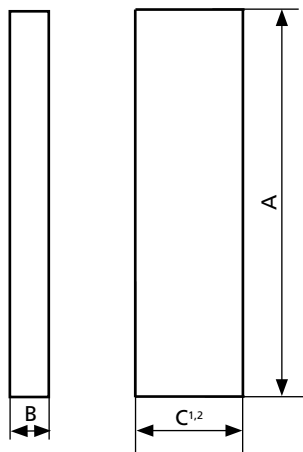

- A 102 mm (4")
- B 7.5 mm (0.3")
- C<sup>1</sup> 37.5 mm (1.5")
- C<sup>2</sup> 25 mm (1.0") Note: Optional accessory

Note: Measures does not include hook and loop fastener

### Round ferrite

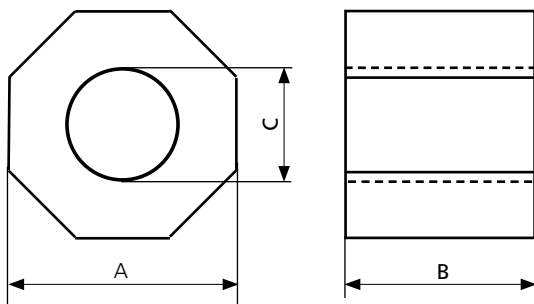

- A 55.5 mm (2.2")
- B 43 mm (1.7")
- C 26 mm (1.0") Max. cable diam. 25.4 mm (1")

### Hook and loop fastener

26 X 290 mm (1.02 X 11.4")

### Transport case

390 x 310 100 mm (15.4" x 12.2" x 3.9")  
4.5 kg (9.9 lbs)  
total kit including transport case

**C-shape ferrite**

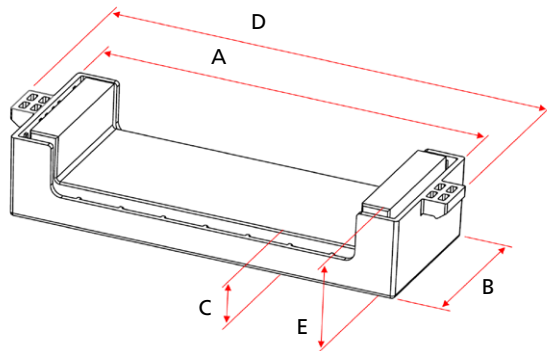

- A 111 mm (4.4")
- B 44 mm (1.7")
- C 11 mm (0.4")
- D 125 mm (4.9")
- E 24 mm (0.9")

**C-Shape Clip ferrite**

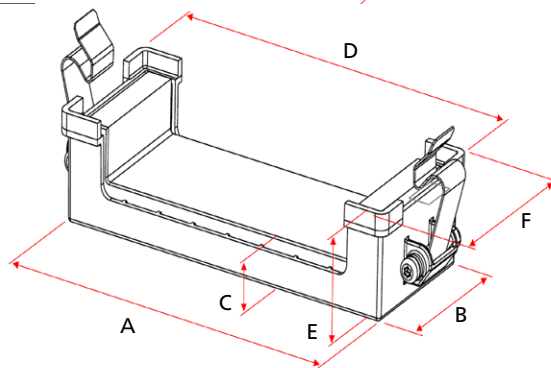

- A 111 mm (4.4")
- B 44 mm (1.7")
- C 11 mm (0.4")
- D 115 mm (4.6")
- E 27 mm (1.1")
- F 49 mm (1.9")

**C+C-shape-mounted ferrite**

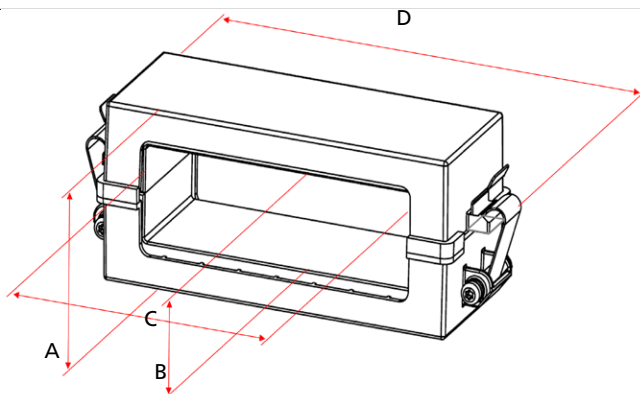

- A 48 mm (1.9")
- B 26 mm (1.0")
- C 85 mm (3.3")
- D 133 mm (5.2") (Over all length including clips)

**I-Shape ferrite**

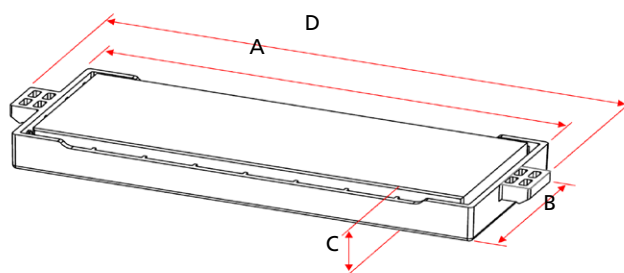

- A 111 mm (4.4")
- B 44 mm (1.7")
- C 11 mm (0.4")
- D 125 mm (4.9")

**C+I-shape mounted ferrite**

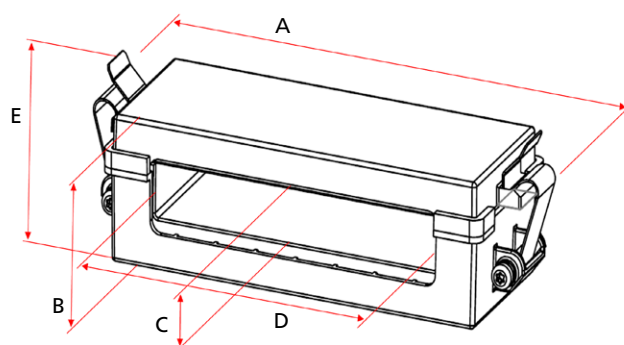

- A 133 mm (5.2") (Over all length including clips)
- B 35 mm (1.4")
- C 13 mm (0.5")
- D 85 mm (3.3")
- E 40 mm (1.6") (Over all height including clips)

# Transducer mounting examples

## Transducer mounting examples

### Analog transducer mounted on a distribution circuit breaker

1. Clamping base
2. Flexible arm
3. Holder angular transducer
4. Novotechnik IP6501
5. Flex coupling
6. Bolt adapter

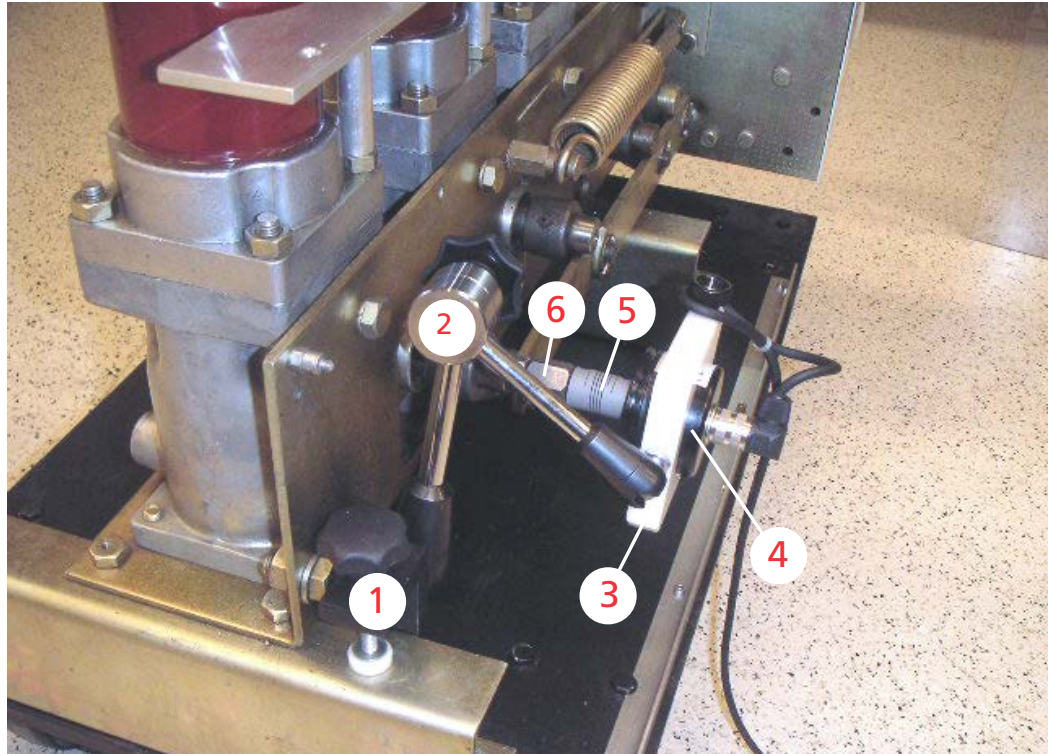

### Analog transducer mounted on a distribution circuit breaker

1. Magnetic base
2. Flexible arm
3. Holder angular transducer
4. Novotechnik IP6501
5. Flex coupling
6. Bolt adapter

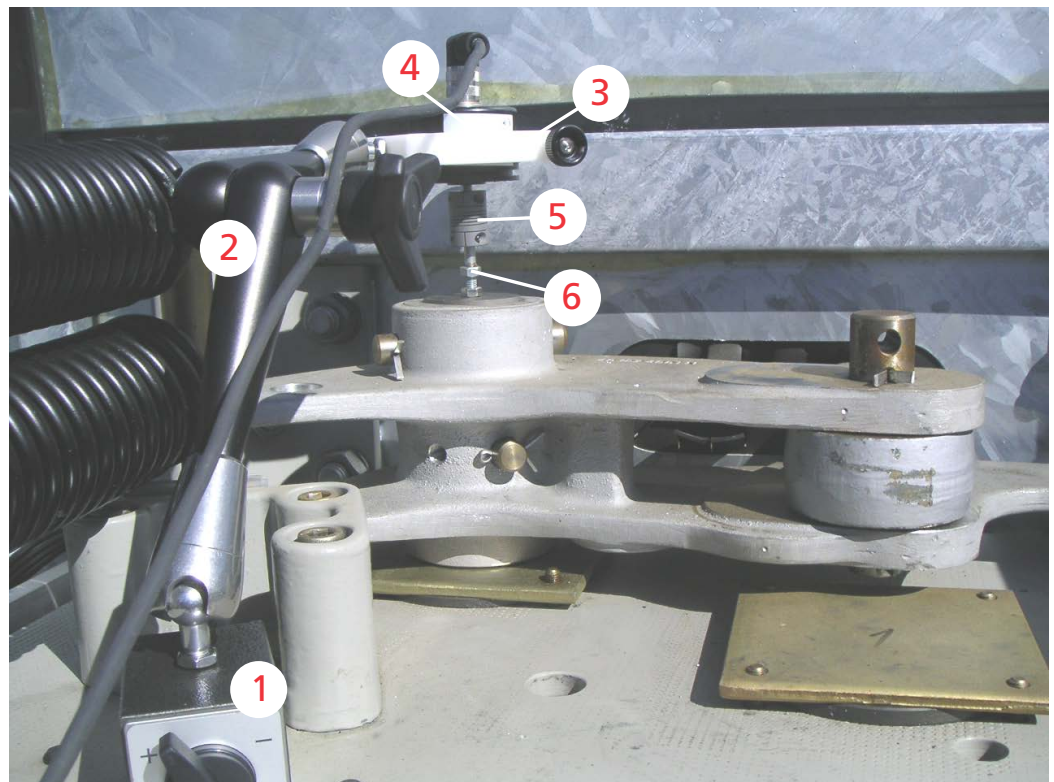



## Factory

Megger Sweden AB  
Rinkebyvägen 19  
SE182 36 Danderyd  
Sweden

## Sales offices

Megger Turkey  
Megger Elektrik Sistemleri  
Test Hizmetleri ve Ticareti LTD.  
Şti. Yaşamkent Mahallesi 3061.  
Cadde No: 64 Çankaya  
ANKARA

Megger  
Millennium Tower  
9th Floor, Office No. 142,  
Bldg. No. 205, Road 2803,  
King Mohammed IV Avenue  
Block No. 428, Seef Area  
Bahrain

Megger Suzhou  
Room 3002-3005  
Building 38  
TusCity, Suzhou Industrial Park  
PRC, China

Megger HK  
Workshop No. 5, 16/F  
Mega Trade Centre  
1-6 Mei Wan St  
Tsuen Wan  
Hong Kong

Megger s.r.o.  
Budečská 18/1010  
120 00 Praha 2  
Czech Republic

Megger Sp.z o.o  
Stara Iwiczna  
aul.Słoneczna 42A  
05-500 Piaseczno  
Poland

Megger France  
9 rue Mickaël Faraday  
78180  
Montigny-le-Bretonneux  
France

Megger India Private Limited  
Blue Wave, 3rd Floor  
Plot No: C22 & C23  
Off Link Road  
Behind Kuber Chambers  
Andheri W, Mumbai  
400053, India

Megger s.r.o.  
Rožňavská 12  
821 04 Bratislava  
Slovakia

Megger Instruments  
S.L.Calle Pedrezuela, 21A  
NAVE 12, Polígono industrial  
Ventorro del Cano  
28925, Alcorcón  
Madrid, Spain

Megger Limited  
Unit 106-550 Alden Road  
Markham  
Ontario  
L3R 6A8  
Canada

Megger Sweden AB  
Box 724  
SE-182 17 DANDERYD  
SWEDEN

[www.megger.com](http://www.megger.com)

**Megger**<sup>®</sup>

CB-Testing-Accessories\_BR\_en\_V10a

The word 'Megger' is a registered trademark. Copyright © 2023