

Accessories for partial discharge measurements

PD 
by Megger®
Power Diagnostix Systems

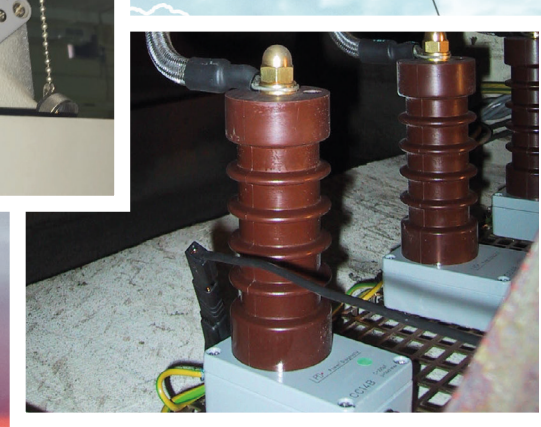
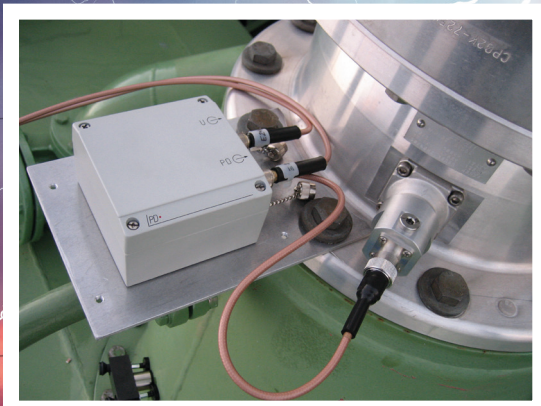

Power Diagnostix

ABOUT POWER DIAGNOSTIX

The Power Diagnostix Group provides quality instruments and engineering services for high voltage diagnostic applications. Power Diagnostix has built a solid reputation since the market introduction of our partial discharge detectors in early 1993. Our ICM series of digital partial discharge detectors is used for the evaluation of electrical insulation by electric utilities, manufacturers, and research institutes worldwide.

In addition to digital partial discharge detectors and monitoring systems, Power Diagnostix produces instruments for commissioning tests on GIS systems, automated control of high voltage tests, fiber optic connections for analogue signal transmission between instruments and sensors, and for other high voltage applications. All of our instruments and specialised software products are developed in Aachen, Germany.

At Power Diagnostix, we understand what is essential for the success of your business. That is why we are dedicated to creating, designing, and manufacturing safe, reliable, easy-to-use test equipment and professional technical services backed by world-leading support and expertise.

We can assist your acceptance, commissioning, and maintenance testing for predictive, diagnostic, or routine purposes. By working closely with electrical utilities, standards bodies, and technical institutions, we contribute to the dependability and advancement of the electrical supply industry.

Our engineers actively participate in regular committees, meetings with all the big trade associations around the world, training organisations, and government organisations, to understand the needs of electrical contractors. So, when new legislation or rules are introduced, you can count on Power Diagnostix to put your interests first, because Power Diagnostix products and services help customers all over the world, improving their efficiency, reducing costs, and meeting standards. It operates globally, with dedicated field sales teams and distributors located in every continent.

Power Diagnostix is certified according to ISO 9001:2015, ISO 14001:2015, and ISO 45001:2018. We offer full service, repair, and calibration services accredited to ISO 17025:2018.



CALIBRATORS

CAL1 series	4
CAL2 series	4
CAL3 series	5
Calibrator connection sets	6

SENSORS

Ultrasonic PD sensors	7
UHF transformer sensors	7
External retrofit UHF sensors for GIS	8
Cable sensors	8

COUPLING DEVICES

Coupling capacitors for permanent installation	9
Coupler termination boxes	10
Mounting kits	10
Coupling capacitors for temporary installation	12
Current transformers	13
Quadrupoles	14

PREAMPLIFIERS AND PRE-PROCESSING UNITS

Standard preamplifiers	16
Frequency converters for GIS applications	17
Preamplifiers with fibre optic isolation	17

BUSHING ACCESSORIES

Bushing adapters	18
Bushing coupling units	19

FILTERS

High voltage filters	21
Ground filter	22
Filter models for special applications	22

CABLE SETS

23

MISCELLANEOUS

Disturbance antennas	24
Isolation transformers	24
Active bridge adapter	24
Gate signal transmitter	24
High voltage transformers	25
Transportation cases for portable instruments	25

SPECIAL SOFTWARE

ICMexpert	26
ICMacoustic	26

PD accessories

Calibration impulse generators

Power Diagnostix offers a wide range of calibration charge injectors (calibrators) suitable for calibrating partial discharge measurements.

PDIX calibrators can be used for high frequency, ultra high frequency, and RIV measurement setups. As such, they are suitable for calibrating test setups for:

- Cables
- Transformers
- Rotating machines
- Gas-insulated switchgear

Thanks to their unique ability to inject a variable voltage step via a fixed capacitor, Power Diagnostix calibrators offer excellent impulse properties

EASY TO USE

- Clear arrangement of the controls
- Large LC display for good readability
- Automatic synchronisation to line frequency by a photo diode
- Convenient connection of the calibrator with ready-to-use connection sets
- Up to 200 hours of operation due to long-life lithium battery

Power Diagnostix calibrators enjoy all the advantages of 20 years' experience in calibration services. The broad range of easy-to-use and robust units for many different applications ensures reliable PD measurements compliant to international standards, such as IEC 60270, CISPR 18-2, and NEMA 107-1987.

CAL1 SERIES

Calibrators of the CAL1 series are suitable for calibrating measurements in high frequency (HF) range. Hence, they can be used with setups for cable and transformer tests as well as for measurements on rotating machines and gas insulated switchgear (GIS), ensuring measurements conform to IEC 60270. Additionally, they can also be used for time domain reflectometry (TDR) in cables to determine the cable length and the location of joints.

For transformer testing, Power Diagnostix offers four different models, all of them being suitable for laboratory and on-line tests.



CAL2 SERIES

Calibrators of the CAL2 series are signal sources for GIS and transformer measurements using ultra high frequency (UHF). To comply with some export restrictions, Power Diagnostix offers special CAL2 models with a typical rise time of 550 ps.

Every UHF impulse generator of the CAL2 series is delivered with a fully traceable DAKKS calibration



PD accessories

Calibration impulse generators

CAL3 SERIES

Power Diagnostix offers three different models of calibration impulse generators for RIV measurements: CAL3A, CAL3B, and CAL3D. They all comply either with NEMA 107-1987 or CISPR 18-2.

The calibrators of the CAL3 series are delivered with a fully traceable factory calibration according to ISO 17025.



The appropriate choice of a calibration instrument depends on the range of typical charge values of the partial discharges being measured.

TYPE	RANGE	INJECTION CAPACITOR (C _i)	IEC 60270 COMPLIANT	CONNECTOR	REMARKS/ APPLICATION	INCLUDED CONNECTION SET
CAL1A	1, 2, 5, 10, 20, 50, 100 pC	<1 pF	●	BNC	Cable and transformer tests	CAL1-CS1
CAL1B	100, 200, 500 pC, 1, 2, 5, 10 nC	<100 pF	●	BNC	High level application, e.g., rotating machines	CAL1-CS1
CAL1C/100	1, 2, 5, 10, 20, 50, 100 pC* at 100 pF	V (50 Ω)	●	BNC	Incl. ext. capacitor 100 pF; cable tests	CAL1-CS4
CAL1C/1000	1, 2, 5, 10, 20, 50, 100 pC* at 100 pF 10, 20, 50, 100, 200, 500, 1000 pC* at 1000 pF	V (50 Ω)	●	BNC	Incl. switchable ext. capacitor 100/1000 pF; cable tests	CAL1-CS4
CAL1D	10, 20, 50, 100, 200, 500, 1000 pC	<10 pF	●	BNC	Laboratory use, transformer tests	CAL1-CS1
CAL1E	0.5, 1, 2, 5, 10, 20, 50 nC	<500 pF	●	BNC	See CAL1B	CAL1-CS1
CAL1F	0.2, 0.5, 1, 2, 5, 10, 20 nC	<200 pF	●	BNC		
CAL1G	0.02, 0.05, 0.1, 0.2, 0.5, 1, 2 nC	<20 pF	●	BNC	Transformer tests	CAL1-CS1
CAL1H/V(+/S)	0.5, 1, 2, 5, 10, 20, 50 pC* at **pF	V (50 Ω)	●	BNC	GIS, live injection via stray capacitance	CAL1-CS5
CAL1J	10, 20, 50, 100, 200, 500, 1000 pC* at 100 pF, 100, 200, 500, 1000, 2000, 5000, 10000 pC* at 1 nF	V (50 Ω)	●	BNC	Incl. switchable ext. capacitor 100pF/1nF; transformer tests	CAL1-CS4
CAL2B(/500)	2, 5, 10, 20, 30, 40, 50 V (into 50 Ω)	V (50 Ω)		N	GIS & UHF	CAL2-CS1
CAL2C(/500)	1, 2, 5, 7, 10, 12, 15, 17, 20 V (into 50 Ω)	V (50 Ω)		N		
CAL2D(/500)	5, 7.5, 10, 15, 20, 30, 40 V (into 50 Ω)	V (50 Ω)		N		
CAL3A	600 kHz to 1.35 MHz, 10 μV to 10 mV	V (50 Ω)		BNC	RIV calibration; NEMA 107 compliant	CAL3-CS1
CAL3B	400 kHz to 1.9 MHz, 10 μV to 10 mV	V (50 Ω)		BNC	RIV calibration; NEMA 107 compliant	
CAL3D	400 kHz to 1.9 MHz, 10 μV to 10 mV (into 300 Ω)	V (>20 KΩ)		BNC	RIV calibration; CISPR 18-2 compliant	

* with external high voltage capacitor, ** value to be specified by customer

PD accessories

Calibration impulse generators

CALIBRATOR CONNECTION SETS

Every PDIX calibrator comes with a set of clamps, plugs, adapters, and pre-assembled cables for comfortable connection of the calibration impulse generator to the measurement setup. The ready-to-use sets include everything for a quick and convenient connection of the device to the specific test setup. The basic cable set consists of one black banana cable (1 m), one green and yellow banana cable (1 m), one black crocodile clip, one green and yellow crocodile clip, and one BNC banana adapter.



CONNECTION SET	CAL1-CS1	CAL1-CS2	CAL1-CS3	CAL1-CS4	CAL1-CS5	CAL2-CS1	CAL2-CS3	CAL3-CS1	CAL3-CS2
Basic cable set	●	●	●	●	●		●	●	●
Banana cable, 4 m black		●						●	
Banana cable, 2.5 m black			●						
RG108 twinaxial cable, 10 m					●				
T-joint (BNC)				●				●	●
T-joint (N)						●			
50 Ω termination				●		●		●	
N-N adapter						●			
N-BNC adapter							●		

ORDERING INFORMATION

Description	Order no.	Description	Order no.
Calibration impulse generator CAL1A	PX15000	Connection set CAL1-CS1 for CAL1	PX15024
Calibration impulse generator CAL1B	PX15001	Connection set CAL1-CS2 for CAL1	PX15025
Calibration impulse generator CAL1C	PX15002	Connection set CAL1-CS3 for CAL1	PX15026
Calibration impulse generator CAL1D	PX15003	Connection set CAL1-CS4 for CAL1	PX15027
Calibration impulse generator CAL1E	PX15004	Connection set CAL2-CS1 for CAL2	PX15011
Calibration impulse generator CAL1F	PX15005	Connection set CAL2-CS3 for CAL2	PX15022
Calibration impulse generator CAL1G	PX15006	Connection set CAL3-CS1 for CAL3	PX15028
Calibration impulse generator CAL1H/V	PX15039	Connection set CAL3-CS2 for CAL3	PX15029
Switching unit for CAL1H/V	PX15040		
Calibration Impulse Generator CAL1J	PX15016		
UHF impulse generator CAL2B	PX15009		
UHF impulse generator CAL2B/500	PX15037		
UHF impulse generator CAL2C	PX15010		
UHF impulse generator CAL2C/500	PX15038		
RIV calibration unit CAL3A	PX15012		
RIV calibration unit CAL3B	PX15013		
RIV calibration unit CAL3D	PX15020		

One standard connection set included with each calibrator!

Options	Order no.
50/60 Hz switchable	PX15104
Double pulse with adjustable time delay (for CAL1 series)	PX15102
Remote power input	PX15107
Selection switch for single pulse/continuous	PX15101

PD accessories

Partial discharge sensors

ULTRASONIC PD SENSORS

Acoustic sensors AS75I and AS150I

The AS75I and AS150I are active sensors with very high sensitivity for measurements on GIS, transformer tanks, or cable joints. They come with a built-in 40 dB preamplifier and can be connected directly to the *AICompact*, *ICMsystem*, *ICMcompact*, and *ICMmonitor* or to the following preamplifiers: RPA1D, RPA1F, RPA1G (see page 16).



Sensor fixtures SFX1, SFX2/30, SFX2/50, and SFX3

The sensor fixture SFX1 is suited to secure the acoustic sensors on a gas insulated switchgear (GIS). The magnetic sensor fixtures of the SFX2 series and the sucking fixture SFX3 are for temporary mounting of the acoustic sensors on a transformer tank.

UHF TRANSFORMER SENSORS

Ultra high frequency (UHF) transformer sensors can be used to detect internal PD on power transformers in a frequency range between 300 MHz and 1 GHz. This range is well suited for measurements under difficult on-site conditions, such as high impact of corona discharges or other disturbances within the typical HF range. UHF partial discharge signals can be used for PD pattern analysis as well as for triggering acoustic measurement systems, like the FOS4, for instance.

Power Diagnostix UHF sensors are suitable for retrofitting as well as for pre-installation.

Flange sensor TFS1 and valve sensors TVS2

- Oil-tight
- Built-in logarithmic UHF-HF converter unit
- Wideband characteristic

The TFS1 sensor is for installation on a transformer's spare flange. It is designed and built in accordance to customer specifications.

The TVS2 sensor is used with transformer oil valves. PDIX offers three standard models for different valve flange diameters:

- TVS2/40, for DN 40
- TVS2/50-80 for DN 50 to DN 80 (diameter 88 to 135 mm)
- TVS2/100 for DN 100

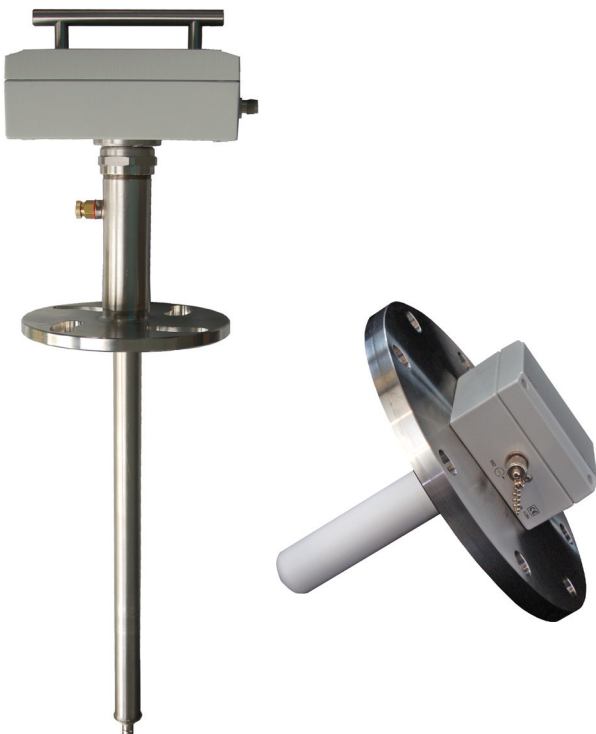

PD accessories

Partial discharge sensors

EXTERNAL RETROFIT UHF SENSORS FOR GIS

Window sensors WS80, WS95, and WS140

External window sensors are used to conveniently equip older GIS with UHF monitoring. Power Diagnostix offers such window sensors of different sizes to fit the inspection windows of older GIS. Here, the obtained results with sensitivity are comparable to embedded sensors, if the window has a diameter of 80 mm or higher. In case well-matched, such external window sensors offer a sensitivity of few pC.



External flange sensor EFS1

The external flange sensor EFS1 is a wide-band UHF antenna for PD detection on GIS and GIL. Since it is wrapped round the unshielded flange connection, the flange dimensions are required on order. With the N connector, it can be directly jointed with a UHF preamplifier such as UHF1 and UHF2 or the frequency converter unit FCU2 (see page page 17). Power Diagnostix offers two different models, for permanent and for temporary installation.

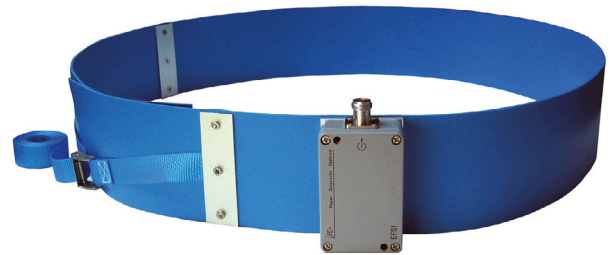

CABLE SENSORS

Differential foil sensor DFS1

Besides the embedded coaxial sensor of cable accessories, external sensors can be applied to joints and terminations. Especially on cross-bonding joints differential foil sensors serve to capture partial discharge signals in elevated frequencies. Such foil sensors can be permanently installed for monitoring or temporarily applied for survey type measurements.

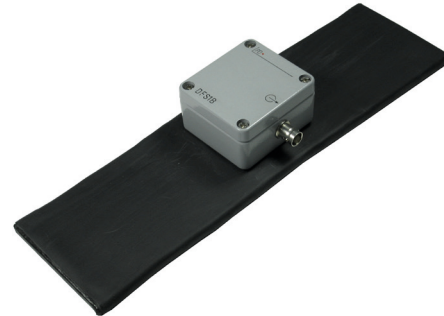

ORDERING INFORMATION

Description	Order no.	Description	Order no.
Acoustic sensor AS75I	PX40100	Transformer valve sensor TVS2/50-80	PX14060
Acoustic sensor AS150I	PX40101	Transformer valve sensor TVS2/100	PX14055
Sensor fixture SFX1	PX40102		
Sensor fixture SFX2/30	PX40103	Window sensor WS80	PX12063
Sensor fixture SFX2/50	PX40104	Window sensor WS95	PX12060
Sensor fixture SFX3	PX40108	Window sensor WS140	PX12061
		External flange sensor EFS1 for permanent installation	PX12113
Transformer flange sensor TFS1	PX14056	External flange sensor EFS1 for temporary installation	PX12057
Transformer valve sensor TVS2/40	PX14059	Differential foil sensor DFS1	PX12053

PD accessories

Coupling capacitors

COUPLING CAPACITORS FOR PERMANENT INSTALLATION

Power Diagnostix coupling capacitors (CC) for permanent installation are designed for decoupling of partial discharge (PD) signals produced by degradation of electrical insulation systems. They are suitable for PD testing and monitoring on high voltage applications up to 30 kV, such as generators and motors. Their specific design meets highest standards to provide high quality measurement results for reliable PD analysis. Power Diagnostix couplers meet or supersede the requirements of all relevant standards.

FEATURES

- Vibration-resistant
- PD-free design
- IEC 60270 and IEC 60034 compliant
- Built-in quadrupole for PD and synchronisation voltage signal
- Internal over-voltage protection
- Sturdy cast aluminium enclosure
- Ready-to-use mounting kits

Our coupling capacitors are versatile in use and suitable for on-line and off-line measurements on:

- Medium voltage motors
- Turbine generators
- Hydro generators
- Distribution transformers

Our couplers fit perfectly to Power Diagnostix' partial discharge measurement instruments and monitoring systems and can be used with the *ICMmonitor* and *ICMsystem*.

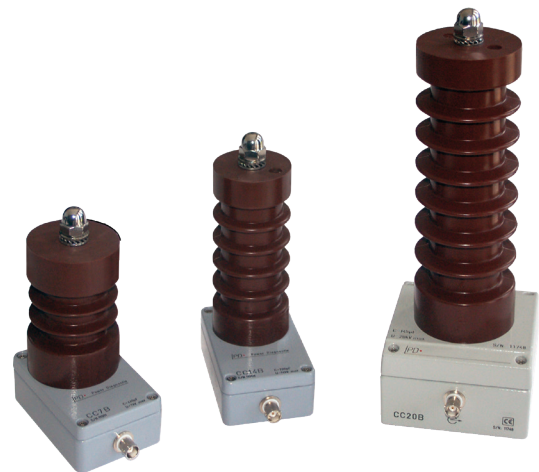

SPECIAL FEED-THROUGH MODELS

Our special capacitor models CC7B/R and CC14B/R are designed for an installation that offers convenient access to the output connector by keeping it outside of the motor terminal box.

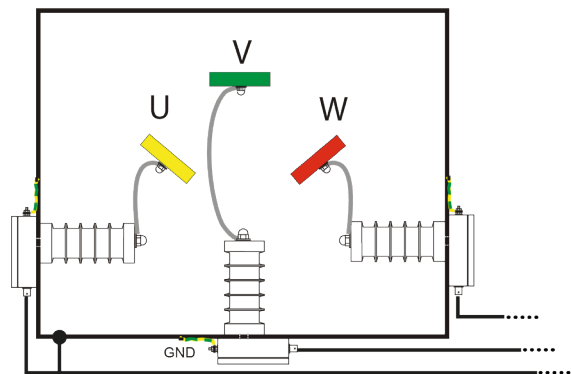

PD accessories

Coupling capacitors

COUPLER TERMINATION BOXES

A coupler termination box is necessary for providing the protective ground for the coupler's BNC signal cable.

- Sturdy cast aluminium enclosure
- Output connectors protected by chained caps
- Built-in overvoltage protection

TYPE	CHANNELS	SPARK GAP	IN	OUT
CTB1A	3	350 V	BNC	BNC
CTB1C	3	350 V	TNC	BNC
CTB2A	4	350 V	BNC	BNC
CTB2C	4	350 V	TNC	BNC



MOUNTING KITS

Save time during installation by using the pre-assembled ready-made cable sets that are precisely adapted to the use of the couplers and different mounting requirements.

- Minimal impact of external interferences by use of double-screened coaxial cables
- Coupler termination box included

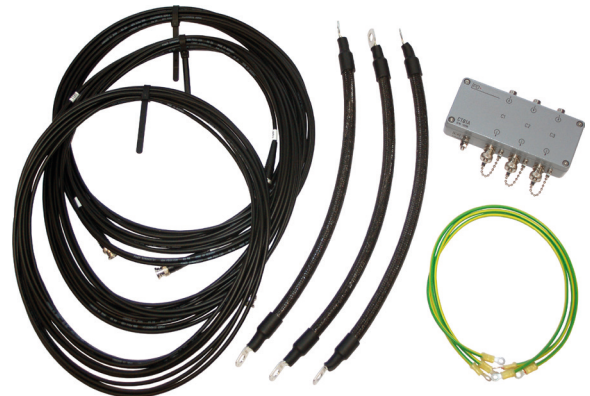

	MOUNTING KIT			
	MKA	MKB	MKC	MKF
Application	Couplers directly bolted to busbar, BNC connectors	Couplers connected to busbar with HV cable, BNC connectors	Couplers connected to busbar with HV cable, BNC connectors, gating option	Couplers connected to busbar with HV cable, TNC connectors
13.8 kV cables, 0.4 m	–	3	4	3
RG58, 10 m	3	3	4	3 (*)
BNC connectors incl. shrink tubings	–	–	–	3
TNC connectors incl. shrink tubings	–	–	–	3
Ground leads, 0.5 m	3	3	4	3
Coupler termination box	CTB1A	CTB1A	CTB2A	CTB1C

(*) not pre-assembled

PD accessories

Coupling capacitors

TYPICAL PACKAGES

- Coupling capacitor **CC7B/R** with mounting kit **MKA** (including coupler termination box **CTB1A**) for feed-through-mounting in motor termination boxes or direct mounting to busbar
- Coupling capacitor **CC14B** with mounting kit **MKB** (including coupler termination box **CTB1A**) for mounting in motor termination boxes (standard)
- Coupling capacitor **CC20B** with mounting kit **MKC** (including coupler termination box **CTB2A**) for use with current transformer for noise gating

ORDERING INFORMATION

Description	Order no.
Coupling capacitor CC7B	PX13187
Coupling capacitor CC7B/R	PX13188
Coupling capacitor CC14B	PX13019
Coupling capacitor CC14B/R	PX13020
Coupling capacitor CC20B	PX13016
Coupler termination box CTB1A	PX18000
Coupler termination box CTB1C	PX18017
Coupler termination box CTB2A	PX18001
Coupler termination box CTB2C	PX18006
Mounting kit MKA	PX18002
Mounting kit MKB	PX18003
Mounting kit MKC	PX18007
Mounting kit MKF	PX18018



PD accessories

Coupling capacitors

COUPLING CAPACITORS FOR TEMPORARY INSTALLATION

Power Diagnostix coupling capacitors for temporary installation are designed for decoupling of partial discharge signals produced by degradation of electrical insulation systems of high voltage equipment, such as rotating machines and transformers. They are suitable for line side and neutral coupling as well as for off-line tests.

Power Diagnostix offers special coupling capacitor models with integrated high frequency current transformer instead of a built-in quadrupole for providing galvanic isolation between the partial discharge detector and the high voltage circuit.

For fault location on cables, coupling capacitors with a built-in broadband quadrupole are available.

FEATURES

- PD-free design
- Built-in quadrupole for PD and synchronisation voltage signal
- Built-in voltage divider
- Sturdy cast aluminium enclosure
- Aluminium base plate with rollers (CC150B/V, CC200B/V, and CC300B/V)



TYPE	CAPACITANCE	NOM. VOLTAGE	SYNC. OUTPUT	BUILT-IN RF CT	BUILT-IN BROADBAND QUADRUPOLE
CC5B/V	2 nF	5 kV	1/50		
CC15B/V	2 nF	15 kV	1/150		
CC25B/V	1 nF	25 kV	1/250		
CC25C/V	1 nF	25 kV	1/250	●	
CC35B/V	145 pF	35 kV	1/350		
CC50B/V	1 nF	50 kV	1/500		
CC50C/V	1 nF	50 kV	1/500	●	
CC50D/V	1 nF	50 kV	1/500		●
CC100B/V	1 nF	100 kV	1/1000		
CC100D/V	1 nF	100 kV	1/1000		●
CC150B/V	1 nF	150 kV	1/1500		
CC200B/V	0.5 nF	200 kV	1/2000		
CC300B/V	0.5 nF	300 kV	1/3000		

ORDERING INFORMATION

Description	Order no.	Description	Order no.
Coupling capacitor CC5B/V	PX13147	Coupling capacitor CC50D/V	PX13082
Coupling capacitor CC15B/V	PX13124	Coupling capacitor CC100B/V	PX13003
Coupling capacitor CC25B/V	PX13013	Coupling capacitor CC100D/V	PX13004
Coupling capacitor CC25C/V	PX13014	Coupling capacitor CC150B/V	PX13001
Coupling capacitor CC35B/V	PX13078	Coupling capacitor CC200B/V	PX13000
Coupling capacitor CC50B/V	PX13006	Coupling capacitor CC300B/V	PX13121
Coupling capacitor CC50C/V	PX13007		

PD accessories

Current transformers

Current transformers (CT) are a low-impact option for sensing partial discharge pulses and sending them as voltage signals to a preamplifier or a pre-processing unit for conditioning. No interruption of the power connection is required. The installation of a CT is even possible under on-line conditions, since most of Power Diagnostix' current transformers can be opened and reassembled or clamped around an already existing connection.

Providing a galvanic isolation between the PD detector or PD on-line monitoring system and the high voltage circuit a current transformer reduces the risk of unwanted damages on the sensitive measurement equipment.

Power Diagnostix current transformers are versatile and suitable for many different test setups. They that can be used with:

- Connecting cables
- Cross link cable boxes
- Cross link box busbars
- Ground leads
- Medium voltage cables
- Coupling capacitor terminals

TYPE	TRANSFER RATIO AT 50 Ω	PRIMARY WINDOW	BANDWIDTH AT -3 DB	BANDWIDTH AT -6 DB
CT1	1:10	15 mm	0.5 – 80 MHz	0.3 – 100 MHz
CT40R	1:10	40 mm	2 – 25 MHz	1.2 – 40 MHz
CT50/10	1:10	50x10 mm	2 – 90 MHz	1.7 – 93 MHz
CT60R	1:10	60 mm	2 – 25 MHz	1.2 – 40 MHz
CT100(R)	1:10	100 mm	2 – 25 MHz	1.2 – 40 MHz
CT125R	1:10	125 mm	2 – 25 MHz	1.2 – 40 MHz
CT150R	1:10	150 mm	2 – 25 MHz	1.2 – 40 MHz

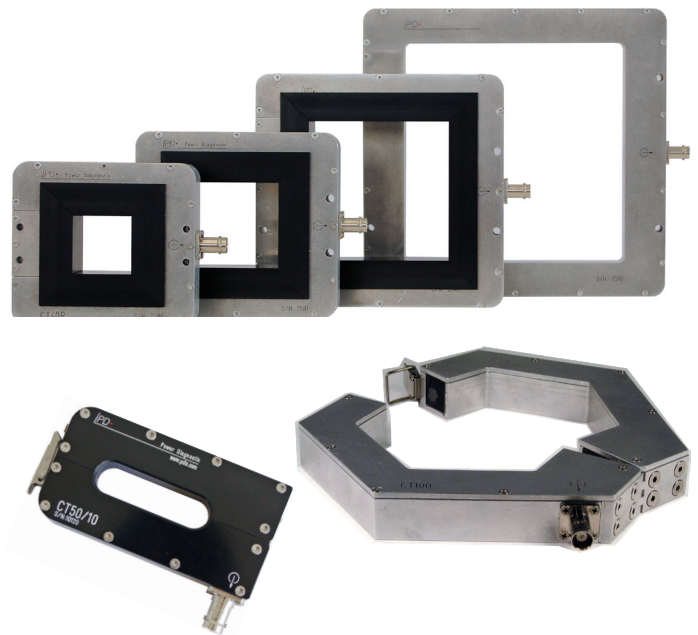

ORDERING INFORMATION

Description	Order no.	Description	Order no.
Current transformer CT1	PX12050	Current transformer CT100	PX12051
Current transformer CT40R	PX12085	Current transformer CT100R	PX12072
Current transformer CT50/10	PX12095	Current transformer CT125 R	PX12073
Current transformer CT60R	PX12084	Current transformer CT150 R	PX12074

PD accessories

Quadrupoles

Quadrupoles act, with a high voltage coupling capacitor or a preamplifier, as a second-order high-pass filter. Every Power Diagnostix quadrupole comes in an aluminium enclosure with protection class IP 65 and is equipped with banana input connectors and BNC output connectors for the PD signal and voltage signal. A connection set is included.

Power Diagnostix offer three basic models of quadrupoles.



CIL QUADRUPOLES

A typical test setup for partial discharge (PD) measurements contains the device under test connected to a high voltage source and a coupling capacitor connected in parallel. A CIL quadrupole (sometimes called measuring impedance) serves to separate the high frequency current of the partial discharge signals from the power frequency current of the capacitor.

CIT QUADRUPOLES

CIT quadrupoles are transformer type units that are used together with a preamplifier. They come with an isolated input (200 V AC) and offer a higher sensitivity than CIL quadrupoles. Therefore, they are particularly well suited for measurements on HV cables.



CIL/V AND CIT/V QUADRUPOLES

CIL/V and CIT/V quadrupoles contain at least one built-in capacitor acting as a voltage divider together with a high voltage coupling capacitor. These CIL/V quadrupoles have an output for a low voltage copy of the applied high voltage wave for synchronisation of the PD detector, such as ICMmonitor, and for monitoring the quality of the applied high voltage wave.

Optionally, Power Diagnostix quadrupoles can be equipped with multiple built-in divider capacitors for voltage measurement. Those quadrupoles have a rotary switch to select the required divider capacitor or to switch to DC mode. When connected to the measurement tap of transformer bushings, the selectable capacitors expand the applicable voltage range.

ORDERING INFORMATION

Description	Order no.	Description	Order no.
Quadrupole CIL3M	PX13120	Quadrupole CIT4M	PX13036
Quadrupole CIL4L	PX13027	Quadrupole CIT4H	PX13038
Quadrupole CIL4M	PX13069	Quadrupole CIT5M	PX13039
Quadrupole CIL4H	PX13029	Quadrupole CIT5H	PX12074
Quadrupole CIL5L	PX12084	Quadrupole CIT6M	PX13042
Quadrupole CIL5M	PX13031	Quadrupole CIT6H	PX13044
Quadrupole CIL5H	PX13032	Quadrupole CIT4M/V2μ0	PX13045
Quadrupole CIL6L	PX13166	Quadrupole CIT4M/V2μ0/10μ0/DC	PX13066
Quadrupole CIL6M	PX13034	Quadrupole CIT5M/V4μ0	PX13094
Quadrupole CIL4M/V1μ0	PX13067	Quadrupole CIT6M/V10μ0	PX13229
Quadrupole CIL4H/V2μ0/4μ0/8μ0/DC	PX13181		
Quadrupole CIL5M/V4μ0	PX13056		
Quadrupole CIL5M/V4μV/8μ0/DC	PX13170		

PD accessories Quadrupoles

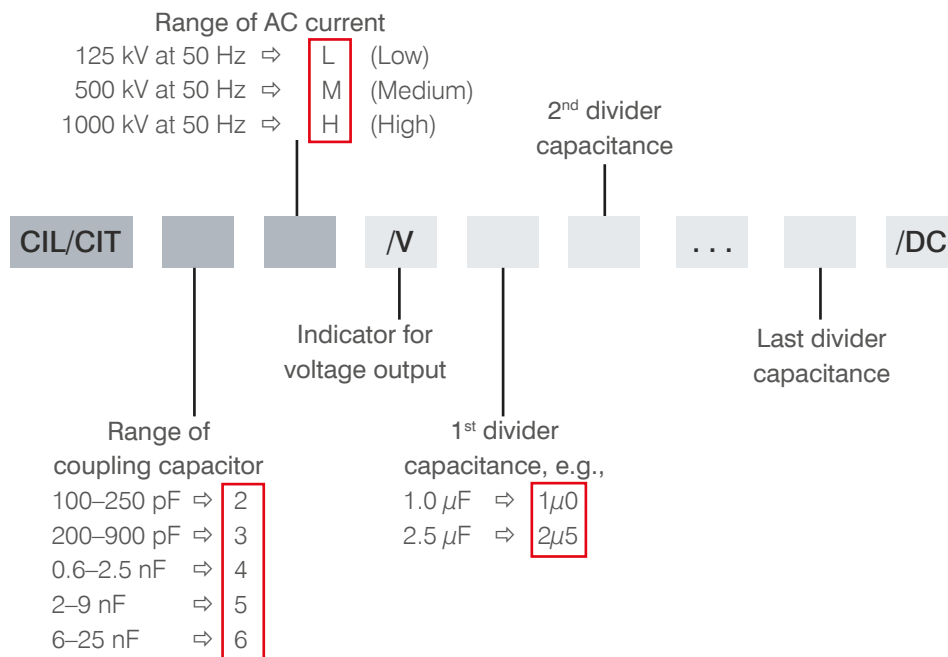

Examples for quadrupoles:

TYPE	COUPLING CAPACITOR RANGE	MAX. AC CURRENT	DIVIDER CAPACITANCE(S)
CIL3M	200 pF–900 pF	200 mA	-
CIL4L	600 pF–2.5 nF	100 mA	-
CIL4H	600 pF–2.5 nF	1100 mA	-
CIL5L	2 nF–9 nF	400 mA	-
CIL5M	2 nF–9 nF	1600 mA	-
CIL6L	6 nF–25 nF	1000 mA	-
CIL6M	6 nF–25 nF	4000 mA	-
CIL4M/V1μ0	600 pF–2.5 nF	400 mA	1 μF
CIL4H/V2μ0/4μ0/8μ0/DC	600 pF–2.5 nF	1100 mA	2 μF, 4 μF, and 8 μF, switchable
CIL5M/V4μV	2 nF–9 nF	1600 mA	4 μF
CIL5M/V4μ0/8μ0/DC	2 nF–9 nF	1600 mA	4 μF and 8 μF, switchable
CIT4M	600 pF–2.5 nF	400 mA	-
CIT4H	600 pF–2.5 nF	1100 mA	-
CIT5M	2 nF–9 nF	1600 mA	-
CIT5H	2 nF–9 nF	3200 mA	-
CIT6M	6 nF–25 nF	4000 mA	-
CIT6H	6 nF–25 nF	8000 mA	-
CIT4M/V2μ0	600 pF–2.5 nF	400 mA	2 μF
CIT4M/V2μ0/10μ0/DC	600 pF–2.5 nF	400 mA	2 μF and 10 μF, switchable
CIT5M/V4μ0	2 nF–9 nF	1600 mA	4 μF
CIT6M/V10μ0	6 nF–25 nF	4000 mA	10 μF

Please contact Power Diagnostix in case you need quadrupoles with customer-specific values.

PD accessories

Preamplifiers and pre-processing units

Power Diagnostix provides a complete line of modular preamplifiers and pre-processing units for various testing applications. The most significant difference among the preamplifiers is the frequency range in which they detect partial discharge signals. Other features that distinguish one preamplifier from another are: Options for transparency and on/off switching, unipolar vs. bipolar charge detection, and the possibility of galvanic isolation in the test setup.

All Power Diagnostix external signal conditioning



units and preamplifiers are remote supplied and remote controlled through a coaxial signal cable. This technique allows placement of these units close to the sensor or signal source and, therefore, provides enhanced overvoltage protection. All preamplifiers of the RPA series can drive a 50 Ω cable with a length of up to 50 m.

Furthermore, as these modules act as impedance converter and line driver, the weak signal source, such as voltage divider or coupling impedance, is not loaded by the cable capacitance or impedance.

TYPE	FREQUENCY RANGE	INPUT IMPEDANCE	INPUT SENSITIVITY	ROLL-OFF	BIPOLAR	REMARKS / APPLICATION
RPA1	40 kHz–800 kHz	10 k Ω //50 pF	<200 μ V	40 dB/Dec	●	Standard preamplifier for measurements with low frequency range
RPA1D	40 kHz–800 kHz	10 k Ω //50 pF	<200 μ V	40 dB/Dec	●	For use with acoustic sensors; built-in sensor supply, switchable (15/28 V)
RPA1E	40 kHz–800 kHz	10 k Ω //50 pF	<200 μ V	40 dB/Dec	●	0/20 dB attenuation
RPA1F	40 kHz–800 kHz	10 k Ω //50 pF	<200 μ V	40 dB/Dec	●	For use with AICompact only
RPA1G	40 kHz–800 kHz	10 k Ω //50 pF	<200 μ V	40 dB/Dec	●	For use with acoustic sensors; built-in sensor supply, switchable (Off/15/28 V)
RPA1H	40 kHz–20 MHz	1 k Ω //50 pF	<400 μ V	40 dB/Dec	●	MV and HV oil/paper cables, DSO
RPA1L	40 kHz–20 MHz	1 k Ω //50 pF	<200 μ V	40 dB/Dec	●	MV and HV cables, DSO
RPA2	2 MHz–20 MHz	50 Ω //50 pF	<800 μ V	40 dB/Dec		On-line measurements on rotating machines
RPA2B	2 MHz–20 MHz	50 Ω //50 pF	<200 μ V	40 dB/Dec		For use with capacitive sensors on cables and cable accessories
RPA3	200 MHz–1 GHz	50 Ω //50 pF	<300 μ V	40 dB/Dec		For use with GIS sensors
RPA3D	50 MHz–400 MHz	50 Ω //50 pF	<300 μ V	40 dB/Dec		Nearfield detection
RPA3E	20 MHz–200 MHz	50 Ω //50 pF	<300 μ V	40 dB/Dec		Nearfield detection
RPA4	40 kHz–800 kHz	10 k Ω //50 pF	<200 μ V	40 dB/Dec	●	Fibre optic isolation
RPA4H	20 kHz–5 MHz	10 k Ω //50 pF	<200 μ V	40 dB/Dec	●	Fibre optic isolation
FCU2	100 MHz–1.8 GHz	50 Ω //50 pF	<200 μ V	40 dB/Dec		Ultra-wide band frequency range; logarithmic output; GIS sensors
FCU3	100 kHz–50 MHz	50 Ω //50 pF	<200 μ V	40 dB/Dec		For use with cable sensors; logarithmic output
UHF1B	150 MHz–1 GHz	50 Ω //50 pF	–	–		For use with GIS sensors
UHF1C	300 MHz–1 GHz	50 Ω //50 pF	–	–		For use with GIS sensors
UHF2	300 MHz–2 GHz	50 Ω //50 pF	–	–		For use with GIS sensors

PD accessories

Preamplifiers and pre-processing units

GIS APPLICATIONS

For capturing PD signals with a larger dynamic range, Power Diagnostix instruments can be ordered with a logarithmic scaling. For this purpose, the frequency converter unit FCU2 with logarithmic output is required. It covers the range of 100 MHz up to 1.8 GHz and, therefore, is mainly used for monitoring of gas insulated switchgear (GIS).

The FCU2 is designed to withstand high voltage transients for most applications; however, in some cases it might be necessary to increase the input protection by an IPU2 unit. This unit is designed to avoid damage of the FCU2 input stage under the presence of very strong transient signals.

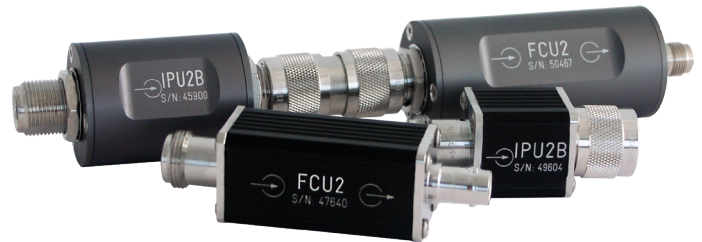

Models for indoor (IP52 protected) and outdoor use (IP65 protected) are available.

FIBRE OPTIC ISOLATION

The RPA4 is a preamplifier set with fibre optical transmission offering outstanding isolation properties. Regarding the frequency response and other properties, this amplifier set behaves similar to the RPA1. It consists of a battery-operated transmitter unit RPA4/T that is connected by two fibre optic cables (20 m) to a receiver unit RPA4/R with built-in battery. The fibre optic cable can isolate 100 kV and more, if kept clean. The attenuation of the fibre optic cable responsible for the analogue transmission from the RPA4/T to the RPA4/R is compensated automatically.

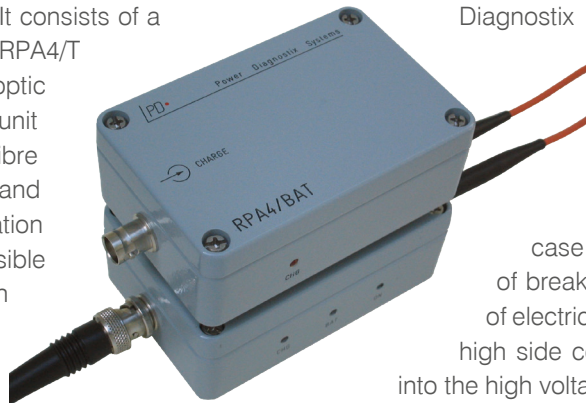

While in standby, the transmitter consumes less than 50 μ A, offering a standby period of several weeks. For extending the eight hours operating time of the built-in battery, Power Diagnostix offers a set of two additional external battery packs which includes a 50/60 Hz power supply for charging purposes.

The use of the fibre optic isolation that is offered by this set is mandatory in case of field measurements bearing a high risk of breakdown, unreliable grounding, and hazard of electrical shock. Furthermore, it may be used for high side coupling, i.e., introducing a coupling unit into the high voltage feeding connection of a test setup.

ORDERING INFORMATION

Description	Order no.	Description	Order no.
Preamplifier RPA1	PX14000	Preamplifier set UHF1B	PX14010
Preamplifier RPA1D	PX14003	Preamplifier set UHF1C	PX14031
Preamplifier RPA1E	PX14004	Preamplifier set UHF2	PX14012
Preamplifier RPA1F	PX14005	Frequency converter unit FCU2 (IP52)	PX14019
Preamplifier RPA1G	PX14024	Frequency converter unit FCU2 (IP65)	PX14021
Preamplifier RPA1H	PX14002	Frequency converter unit FCU3 (IP52)	PX14039
Preamplifier RPA1L	PX14001	Frequency converter unit FCU3 (IP65)	PX14054
Preamplifier RPA2	PX14006	Input protection unit IPU2B (IP52)	PX14020
Preamplifier RPA2B	PX14007	Input protection unit IPU2B (IP65)	PX14022
Preamplifier RPA3	PX14008		
Preamplifier RPA3D	PX14049	Options	Order no.
Preamplifier RPA3E	PX14009	External battery set for preamplifier set RPA4	PX14034
Preamplifier set RPA4 (incl. FO cables)	PX14013	External spare battery for preamplifier set RPA4	PX30117
Preamplifier set RPA4 (w/o FO cables)	PX14063		
Preamplifier set RPA4H (incl. FO cables)	PX14051		

PD accessories

Bushing adapters and coupling units

BUSHING ADAPTERS

Power Diagnostix offers various bushing adapters fitting to many different models of bushing test tabs. Other adapter models are available on request and will be custom made. Every adapter has

two built-in surge arresters (spark gaps) as overvoltage protection and is available with a stainless steel housing without colouring or a housing made of anodised aluminium (ca. RAL 9006).

TYPE	THREAD	SIZE	CONNECTOR	SIZE	DIMENSIONS	WEIGHT
BA2	Inside	G3/4"	Female	4 mm	Ø50 x 64 mm	170 g
BA3	Outside	M45x2	Female	8 mm	Ø65 x 118 mm	1 kg
BA4 adapt.	Flange Inside	-- M76x1.5	Male	8 mm	□70 x 103 mm	400 g
BA5	Inside	M24	Male	4 mm	□41 x 79 mm	200 g
BA6	Outside	M38x1.5	Male	4 mm	Ø44 x 80 mm	190 g
BA7C	Outside	2¼"-12 UNF	Female	8 mm	Ø80 x 104 mm	190 g
BA7D	Outside	2¼"-12 UNF	Female	3.5 mm	Ø80 x 104 mm	190 g
BA8	Inside	5/8"-11 UNC	-	3 mm	□30 x 70 mm	100 g
BA9	Outside	M30x1.5	Female	4 mm	Ø50 x 60 mm	180 g
BA9B	Inside	M30x1.5	Female	8 mm	Ø50 x 66 mm	180 g
BA10	Outside	M16x1.5	Female	4 mm	Ø55 x 64 mm	120 g
BA10B	Outside	M16x1.5	Female	4 mm	Ø34 x 64 mm	90 g
BA10C	Outside	M16x1.5	Female	4 mm	Ø25 x 61 mm	60 g
BA11	Flange		Female	8 mm	□85 x 100 mm	500 g
BA12	Outside	M30x2	Female	6 mm	Ø45 x 87 mm	200 g
BA14	Outside	1 1/16"-12 UN	Female	8 mm	Ø45 x 100 mm	210 g
BA15	Outside	M30x2	Female	9 mm	Ø45 x 102 mm	200 g
BA17	Outside	M30x2	Female	4 mm	Ø40 x 82 mm	190 g
BA18	Flange	--	Female	8 mm	41 x 72 x 127 mm	180 g
BA19	Flange	--	Female	8 mm	□82 x 105 mm	1 kg
BA21	Outside	M24x1.5	Female	4 mm	Ø50 x 71 mm	180 g
BA21B	Outside	M24x1.5	Female	4 mm	Ø50 x 71 mm	180 g
BA23	Inside	M36x3	Female	5 mm	Ø40 x 59 mm	180 g
BA25	Outside	1¼"-12 UNF	Spring	5 mm	Ø45 x 60 mm	140 g
BA26	Outside	1 1/8"-12 UNF	Female	1/4"	Ø50 x 60 mm	150 g
BA27	Outside	1 1/8"-12 UNF	Female	8 mm	Ø45 x 70 mm	150 g
BA28	Outside	¾"-14 NPSM	Spring	9 mm	Ø34 x 56 mm	80 g
BA29	Inside	M33x1.5	Female	4 mm	Ø43 x 62 mm	330 g
BA30	Inside	M30x1.5	Female	6 mm	Ø44 x 61 mm	150 g
BA31	Inside	4x6 holes, dist.: 44 mm	Female	10 mm	□58 x 53 mm	100 g
BA32	Inside	M42x1.5	Female	6 mm	Ø49 x 76 mm	400 g
BA33	Outside	M20x1.5	Male	5.3 mm	Ø44 x 59 mm	150 g
BA34	Inside	M20x1.5	Male (adapter)	M6	Ø43 x 91 mm	350 g
BA35	Inside	M24x1	Male (adapter)	M6	Ø43 x 93 mm	350g



PD accessories

Bushing adapters and coupling units

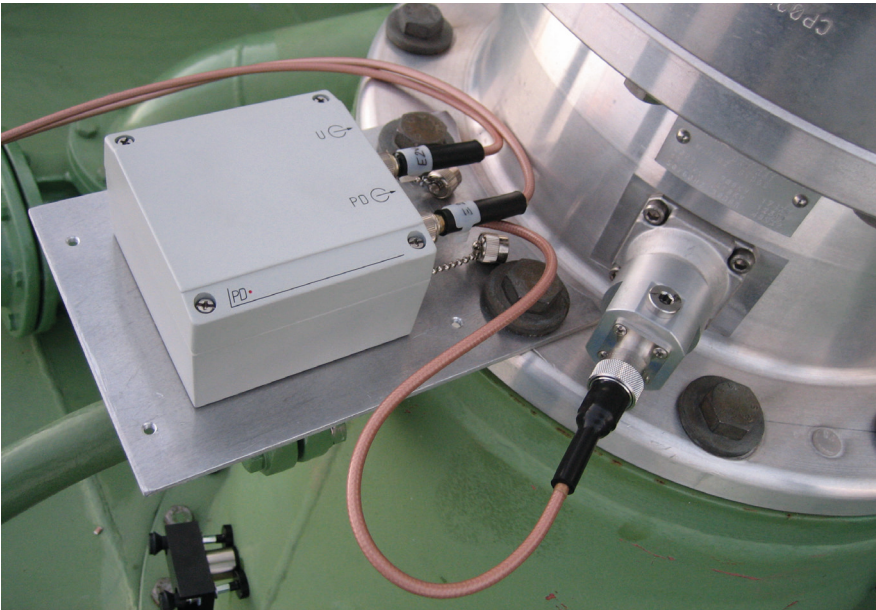

For manufacturing a custom made bushing adapter, Power Diagnostix needs the dimensions of the bushing's test tap. We have created a document to help our customers determine the most important dimensions.



BUSHING COUPLING UNITS

Bushing coupling units are for permanent installation on power transformers. Together with a matching bushing adapter they make different signals available for measurement and monitoring. The bandwidth of the partial discharge signals extends to 20 MHz. The voltage signal of the built-in capacitive divider serves to synchronise the partial discharge acquisition and to measure the voltage. However, the excellent bandwidth of the voltage signal also allows transfer impedance measurements and loss factor measurements.

Power Diagnostix offers two different models: BCU2C for the output of a PD and a voltage signal and BCU2D for the output of a voltage signal and a PD signal with superimposed voltage signal.

The standard bushing coupling units come in an IP 66 protected aluminium enclosure and with a PTFE insulated input cable. Thus, the BCUs are suitable for indoor and outdoor use. For offshore applications is a stainless steel coupling unit enclosure available.

The voltage range and bushing capacitances (C1 and C2) have to be specified on order.

Please contact Power Diagnostix for assistance in determining the values that fit for your specific application.



PD accessories

Bushing adapter and coupling units

ORDERING INFORMATION

Description	Order no.	Description	Order no.
Bushing adapter BA2, anodised aluminium	PX12024	Bushing coupling unit BCU2C, Cd=0.05 μ F	PX13314-03
Bushing adapter BA2, stainless steel	PX12029	Bushing coupling unit BCU2C, Cd=0.15 μ F	PX13314-04
Bushing adapter BA3, anodised aluminium	PX12011	Bushing coupling unit BCU2C, Cd=0.55 μ F	PX13314-02
Bushing adapter BA4, anodised aluminium	PX12018	Bushing coupling unit BCU2C, Cd=0.68 μ F	PX13268
Bushing adapter BA5, anodised aluminium	PX12002	Bushing coupling unit BCU2C, Cd=0.9 μ F	PX13122
Bushing adapter BA6, anodised aluminium	PX12003	Bushing coupling unit BCU2C, Cd=1.5 μ F	PX13281
Bushing adapter BA7B, anodised aluminium	PX12016	Bushing coupling unit BCU2C, Cd=1.6 μ F	PX13314-01
Bushing adapter BA7C, anodised aluminium	PX12034	Bushing coupling unit BCU2D, Cd=0.033 μ F	PX13258
Bushing adapter BA7C, stainless steel	PX12036	Bushing coupling unit BCU2D, Cd=0.04 μ F	PX13258-01
Bushing adapter BA7D, anodised aluminium	PX12090	Bushing coupling unit BCU2D, Cd=0.047 μ F	PX13258-02
Bushing adapter BA8, anodised aluminium	PX12005	Bushing coupling unit BCU2D, Cd=0.056 μ F	PX13258-03
Bushing adapter BA9, anodised aluminium	PX12025	Bushing coupling unit BCU2D, Cd=0.1 μ F	PX13258-04
Bushing adapter BA9, stainless steel	PX12030	Bushing coupling unit BCU2D, Cd=0.12 μ F	PX13258-05
Bushing adapter BA9B, anodised aluminium	PX12039	Bushing coupling unit BCU2D, Cd=0.18 μ F	PX13258-06
Bushing adapter BA9B, stainless steel	PX12040	Bushing coupling unit BCU2D, Cd=0.22 μ F	PX13258-07
Bushing adapter BA10, anodised aluminium	PX12012	Bushing coupling unit BCU2D, Cd=0.25 μ F	PX13258-08
Bushing adapter BA10C, anodised aluminium	PX12041	Bushing coupling unit BCU2D, Cd=0.27 μ F	PX13258-09
Bushing adapter BA10C, stainless steel	PX12042	Bushing coupling unit BCU2D, Cd=0.33 μ F	PX13258-10
Bushing adapter BA10F, anodised aluminium	PX12048	Bushing coupling unit BCU2D, Cd=0.39 μ F	PX13258-11
Bushing adapter BA11, anodised aluminium	PX12008	Bushing coupling unit BCU2D, Cd=0.4 μ F	PX13258-12
Bushing adapter BA12, anodised aluminium	PX12009	Bushing coupling unit BCU2D, Cd=0.47 μ F	PX13258-13
Bushing adapter BA14, anodised aluminium	PX12019	Bushing coupling unit BCU2D, Cd=0.56 μ F	PX13258-14
Bushing adapter BA15, anodised aluminium	PX12020	Bushing coupling unit BCU2D, Cd=0.68 μ F	PX13258-15
Bushing adapter BA17, anodised aluminium	PX12032	Bushing coupling unit BCU2D, Cd=0.8 μ F	PX13258-16
Bushing adapter BA17, stainless steel	PX12033	Bushing coupling unit BCU2D, Cd=0.82 μ F	PX13258-17
Bushing adapter BA18, anodised aluminium	PX12013	Bushing coupling unit BCU2D, Cd=1.0 μ F	PX13258-18
Bushing adapter BA19, anodised aluminium	PX12014	Bushing coupling unit BCU2D, Cd=1.1 μ F	PX13258-19
Bushing adapter BA21, anodised aluminium	PX12027	Bushing coupling unit BCU2D, Cd=1.2 μ F	PX13258-20
Bushing adapter BA21, stainless steel	PX12031	Bushing coupling unit BCU2D, Cd=1.5 μ F	PX13258-21
Bushing adapter BA21B, anodised aluminium	PX12028	Bushing coupling unit BCU2D, Cd=1.8 μ F	PX13258-22
Bushing adapter BA23, anodised aluminium	PX12043	Bushing coupling unit BCU2D, Cd=2.65 μ F	PX13243
Bushing adapter BA23, stainless steel	PX12044	Bushing coupling unit BCU2D, Cd=3.9 μ F	PX13258-23
Bushing adapter BA25, anodised aluminium	PX12037		
Bushing adapter BA25, stainless steel	PX12038		
Bushing adapter BA27, anodised aluminium	PX12045	Options	Order no.
Bushing adapter BA27, stainless steel	PX12046	Stainless steel coupling unit enclosure CUE1	PX12092
Bushing adapter BA28, anodised aluminium	PX12109		
Bushing adapter BA29, anodised aluminium	PX12116		
Bushing adapter BA29, stainless steel	PX12115		
Bushing adapter BA30, stainless steel	PX12123		
Bushing adapter BA31, anodised aluminium	PX12124		
Bushing adapter BA32, anodised aluminium	PX13317		
Bushing adapter BA33, anodised aluminium	PX12130		
Bushing adapter BA34, anodised aluminium	PX12131		
Bushing adapter BA35, anodised aluminium	PX12132		

HIGH VOLTAGE FILTERS

Partial discharge measurements are conducted in frequency ranges, which are partly covered by radio transmission. Further, impulse noise interference hamper sensitive measurements. Besides using small filters in the acquisition chain, power filters allow removing such disturbance from the high voltage supply.

Power Diagnostix offers a range of different high voltage filters for various applications. Every model is equipped with multi-contact (MC) connectors for convenient handling of the HV connections.

T-Filters



Power Diagnostix T-filters are designed to reduce high frequent disturbance signals from the high voltage supply. Their main application is induced voltage testing on motors and large power transformers. The standard filters come with B18N (multi-contact) connectors, but other connectors are available on request. Equipped with a ground plate on wheels the filters can be easily moved and are ideal for flexible test set-ups.

NAME	$U_{N,RMS}$	$I_{N,RMS}$
T30/1	30 kV	1 A
T30/5	30 kV	5 A
T30/20	30 kV	20 A
T30/100	30 kV	80 A
T50/1	50 kV	1 A
T50/5	50 kV	5 A
T50/20	50 kV	20 A
T50/100	50 kV	80 A
T100/1	100 kV	1 A
T100/5	100 kV	5 A
T100/20	100 kV	20 A
T100/100	100 kV	80 A

HV filters of different ratings (U_N , I_N) are available on request.

π -Filters

π -Filters are for testing procedures with voltages up to 2 kV. Standard π -filters are available for three-phase and single-phase systems, but special models for testing of two phases are available on request.

NAME	$U_{N,RMS}$	$I_{N,RMS}$	3-PHASE	1-PHASE
1PI2/50	2 kV	50 A		●
3PI2/20	2 kV	20 A	●	
3PI2/50	2 kV	50 A	●	



Connection cables for HV filters

On request, Power Diagnostix provides tailor made high voltage cables for connecting HV filters to an HV source and the partial discharge measurement system as well as for grounding purposes.



PD accessories

Filters

GROUND FILTER

Partial discharge measurement requires a reasonable noise-free environment. Power Diagnostix' GF50 filter box is designed to reduce high frequent disturbance signals from the ground leads. It can be used for HF separation of the test specimen from the ground potential of the power supply or other HV equipment within the environment without influencing the power frequency. The efficiency strongly depends on the general earthing within the laboratory. A split ground lead or copper band can be connected to the multi contact connectors or alternatively to the wing screws beside.

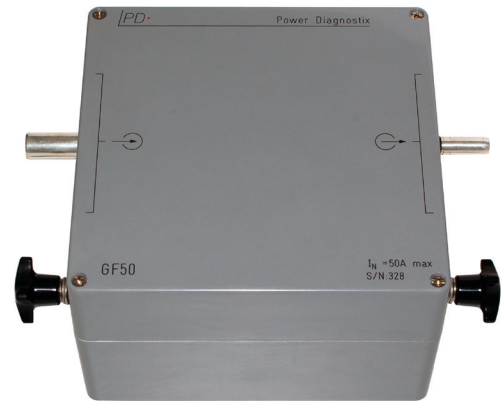

FILTER MODELS FOR SPECIAL APPLICATIONS

Besides the standard HV filters, Power Diagnostix offers various filters for special high voltage applications, including line filters for cable testing and filters with AC current and AC voltage measurement. With the latter a high voltage filter is combined with a high voltage divider and a high current transformer in one unit; conventionally on a plate with rolls, or upside-down, as shown.

Please contact Power Diagnostix for further information on the range of high voltage filters for special applications.



ORDERING INFORMATION

Description	Order no.	Description	Order no.
High voltage filter T30/1	PX10635	1-phase high voltage filter 1Pi2/50	PX16047
High voltage filter T30/5	PX10641	3-phase high voltage filter 3Pi2/20	PX15056
High voltage filter T30/20	PX10629	3-phase high voltage filter 3Pi3/50	PX16035
High voltage filter T30/100	PX10642		
High voltage filter T50/1	PX10634	Ground filter GF50	PX90121
High voltage filter T50/5	PX10619		
High voltage filter T50/20	PX10636	Accessories	Order no.
High voltage filter T50/100	PX10614	Transportation case for T30/x filters	PX18119
High voltage filter T100/1	PX10632	High voltage connection cable (length to be specified)	PX17097
High voltage filter T100/5	PX16055	Multi-contact male connector for high voltage cables	PX17163
High voltage filter T100/20	PX16021	Multi-contact female connector for high voltage cables	PX17164
High voltage filter T100/100	PX16010	Red clamp termination for high voltage cables	PX17085
		Black clamp termination for high voltage cables	PX17099

DOES THIS SITUATION SOUND FAMILIAR? YOU HAVE MANY DIFFERENT INSTRUMENTS AND MANY DIFFERENT CABLES AND, DESPITE THIS HUGE INVENTORY, YOU'RE ALWAYS MISSING THE EXACT CABLE YOU NEED IN THE MOMENT?

POWER DIAGNOSTIX OFFERS A WIDE RANGE OF PRE-ASSEMBLED AND READY-TO-USE CABLE SETS THAT PERFECTLY MATCH YOUR INSTRUMENT AND YOUR APPLICATION. CONTACT US AND WE WILL HELP YOU TO FIND THE APPROPRIATE CABLES FOR YOU.

PD accessories

Miscellaneous

DISTURBANCE ANTENNAS

The disturbance antenna DA1 can be used to pick up noise signals caused by local corona discharge or AM radio waves, for example. Its magnetic holder allows a flexible placement on a transformer tank or to other metallic parts close to the object under test. The output signal can be used to trigger the gate input circuit of all PD acquisition or monitoring devices.



The wideband antenna DA2 consists of a UHF antenna and a frequency converter unit. It is designed to filter HF signals, e.g., emitted by GSM transmitting antennas. Therefore, it is especially used for monitoring of gas insulated switchgear.

ORDERING INFORMATION

Description	Order no.
Disturbance antenna DA1	PX12055
Disturbance antenna DA2	PX12066

ACTIVE BRIDGE ADAPTER

The active bridge adapter AB1 is an optional accessory that can be used to 'subtract' noise from a measurement setup with two branches. The AB1 serves to balance the signal picked up by two preamplifiers to reduce the common mode noise or disturbance.

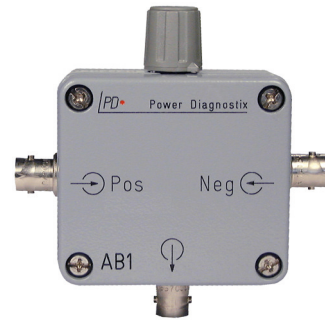

ORDERING INFORMATION

Description	Order no.
Active bridge adapter AB1	PX18100

ISOLATION TRANSFORMERS

An isolation transformer allows the permanent isolation of 250 Volts between its input and output. Its high frequency behaviour is optimised for 50 Ω systems and for the use with a multiplexer and a preamplifier such as RPA2 or RPA2B. Special models with an additional voltage output are available on request. These IT/V isolation transformers have a built-in voltage divider and provide a low voltage copy of the applied high voltage wave for synchronisation of the PD detector.

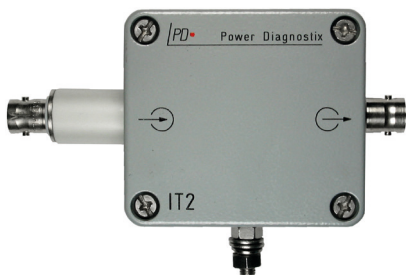

ORDERING INFORMATION

Description	Order no.
Isolation transformer IT2C	PX13047
Isolation transformer IT3B	PX13048
Isolation transformer IT3B/V2μ0	PX13127
Isolation transformer IT3B/V4μ0	PX13049
Isolation transformer IT4B	PX13050
Isolation transformer IT4B/V4μ0	PX13051

GATE SIGNAL TRANSMITTER

The gate signal transmitter GST1 converts TTL or analogue gate signals into a fibre optic TTL output signal. It has a logarithmic amplification and can be set to three different frequency ranges (40 to 800 kHz, 2 to 20 MHz, or 200 to 600 MHz), which can be selected with a push button.

The active bandwidth mode is marked by a lit green LED.

The trigger level can be adjusted by a rotary knob, while an LED bargraph indicates the actual signal strength.

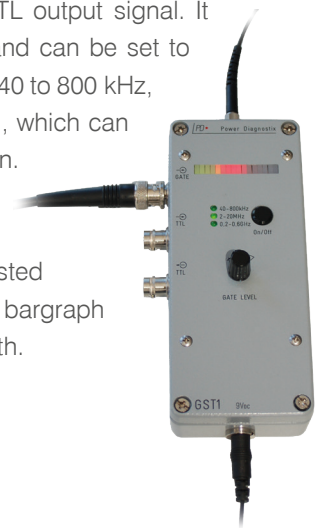

ORDERING INFORMATION

Description	Order no.
Gate signal transmitter GST1	PX12055

HIGH VOLTAGE TRANSFORMERS

Power Diagnostix offers miscellaneous transformers as voltage source for testing purposes. Depending on the customer's needs and the specific testing application, Power Diagnostix high voltage transformers cover a voltage range up to 300 kV. Please contact us for detailed information.

ORDERING INFORMATION

Description	Order no.
High voltage transformer HVT15/25	PX50409
High voltage transformer HVT100/10	PX50405
High voltage transformer HVT100/10	PX50260
Control cables for high voltage transformers	PX17162



TRANSPORTATION CASES FOR PORTABLE INSTRUMENTS

All Power Diagnostix instruments can be delivered with a solid transportation case made of high performance plastic compound with customised cut-out foam. It allows the safe handling and transport of one instrument and its accessories.

The cases are water and dust tight according to ingress protection class IP 67.

ORDERING INFORMATION

Description	Order no.
Transportation case for ICMsystem with up to 4 channels and accessories	PX18126
High transportation case for ICMsystem with up to 4 channels and accessories	PX18122
Transportation case for ICMsystem with 5 to 10 channels and accessories	PX18120
Transportation case for AICompact with desktop housing	PX18121
Transportation case for AICompact and ICMcompact with Explorer housing	PX18125
Transportation case for ICMcompact with desktop housing	PX18127
Transportation case for GISmonitor Portable	PX18123
High transportation case for GISmonitor Portable	PX18129
Transportation case for ATTAnalyzer	PX18124
Transportation case for connection cables	PX18111



PD accessories Special software

ICMexpert

ICMexpert is a database software for managing partial discharge (PD) patterns and extends the possibilities of Power Diagnostix programs like ICMcompact, ICMmonitor, ICMsystem, HVPilot, ICMflex, and GISmonitor. This easy-to-use tool offers functions for three main tasks occurring regularly when doing PD measurements:

- Classification of pattern according to their PD fault(s)
- Pattern editing to correct deficiencies of the set-up, erase disturbances, and highlighting pattern regions characterising typical PD faults
- Adding and maintaining additional information to recorded pattern

For each of these tasks ICMexpert provides a separate software panel.

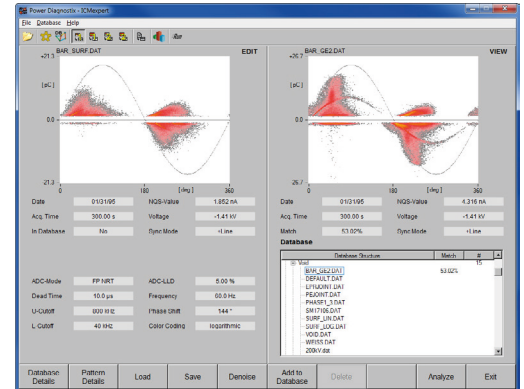

The database structure is customisable according to different applications and user requirements. Additionally, the ICMexpert software supports the export of complete clones or parts of the database. Clones can be used to operate with the same database structure on different computers staying compatible with each of the used database files.

ICMacoustic

For PD location purposes the ICMacoustic software offers simple and full control of the FOsystem FOS4 or an oscilloscope of the Tektronix 20xx family. The software provides a virtual instrument to run the FOS4 or the oscilloscope under Windows 7, 8, and 10 (32 bit). Critical frequencies can easily be detected and filters can be set for in-depth analysis.

Contained functions are:

- Simultaneous display of up to 12 channels of the FOS4
- Accurate fault location by triangulation with freely configurable parameters for the different propagation velocities in oil and steel
- Screenshot functions
- Analysis and visualisation of measurement results through customisable 3D models
- Extensive report and export functions for measuring results and graphical representation of the fault location
- Convenient step-by-step wizard during the measurement

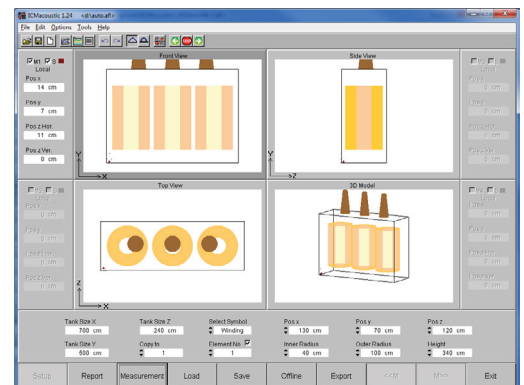

ORDERING INFORMATION

Description	Order no.	Description	Order no.
Software ICMexpert	PX19022	Software ICMacoustic	PX19008



Power Diagnostix Systems GmbH
Vaalser Strasse 250, 52074 Aachen, Germany
Tel. +49 241 74927, Fax. +49 241 79521
E-Mail: support(at)pdix.com

www.pdix.com

[PDIX_Accessories_CT_EN_v5_DIGITAL](#)

We reserve the right to make technical changes.

The word 'Megger' is a registered trademark. © Copyright 2024

PD 
by Megger®
Power Diagnostix Systems