

Megger



SVERKER 750/780

Relay test unit

User guide

SVERKER 750/780

Relay test unit

User guide

NOTICE OF COPYRIGHT & PROPRIETARY RIGHTS

© 2013-2023, Megger Sweden AB. All rights reserved.

The contents of this manual are the property of Megger Sweden AB. No part of this work may be reproduced or transmitted in any form or by any means, except as permitted in written license agreement with Megger Sweden AB. Megger Sweden AB has made every reasonable attempt to ensure the completeness and accuracy of this document. However, the information contained in this manual is subject to change without notice, and does not represent a commitment on the part of Megger Sweden AB. Any attached hardware schematics and technical descriptions, or software listings that disclose source code, are for informational purposes only. Reproduction in whole or in part to create working hardware or software for other than Megger Sweden AB products is strictly prohibited, except as permitted by written license agreement with Megger Sweden AB.

TRADEMARK NOTICES

Megger® and Programma® are trademarks registered in the U.S. and other countries. All other brand and product names mentioned in this document are trademarks or registered trademarks of their respective companies.

Megger Sweden AB is certified according to ISO 9001 and 14001.

Postal address:

Megger Sweden AB
Box 724
SE-182 17 DANDERYD
SWEDEN

T +46 8 510 195 00
E seinfo@megger.com

Visiting address:

Megger Sweden AB
Rinkebyvägen 19
SE-182 36 DANDERYD
SWEDEN

www.megger.com



Contents

1 Safety

.....	6
Symbols on the instrument	6

Safety instructions	6
----------------------------------	----------

2 Introduction

.....	8
2.1 Applications.....	8
2.2 Design and construction	8

3 Description

.....	10
3.1 General.....	10
SVERKER 750 control panel	10
SVERKER 780 control panel	10
3.2 Current source	11
3.3 Timer.....	12
Start conditions	12
Stop conditions.....	12
3.4 Trip indicator.....	13
3.5 Display.....	13
3.6 Ammeter & voltmeter	14
3.7 AC Voltage source	15
3.8 Auxiliary voltage source	15
3.9 Make/Break contact.....	16
3.10 Resistor set and capacitor.....	16
3.11 Power supply	17
3.12 Computer interface.....	17

4 Control panels

.....	18
4.1 Front panels.....	18
SVERKER 750.....	18
SVERKER 780.....	19
4.2 Current source	20
4.3 Timer.....	21
4.4 Trip indicator.....	22
4.5 Display.....	22
4.6 Ammeter & voltmeter	23
4.7 AC Voltage source	23
SVERKER 750.....	23
SVERKER 780.....	23
4.8 Auxiliary voltage source	24

4.9 Make/Break contact	24
4.10 Resistor set and capacitor.....	25
4.11 Power supply	25
4.12 Other.....	26

5 Making settings on the display

28	
5.1 Introduction.....	28
5.2 Button functions.....	29
5.3 Direction indicator	29
5.4 The menu system.....	30
5.5 Test mode.....	31
5.6 Injection.....	32
5.7 Ammeter	32
5.8 Voltmeter.....	33
5.9 Ω , φ , W , VA... (Extra measurement)	33
5.10 Timer.....	34
5.11 Display.....	34
5.12 Off delay.....	35
5.13 0-Level filter.....	35
5.14 Save/Recall.....	36
5.15 Remote control	36
5.16 Language.....	37
5.17 SW	37

6 How to operate

SVERKER	38
6.1 General.....	38
6.2 Injecting current – General rules	38
Output alarm.....	38
6.3 Selecting the correct current output.....	39
6.4 Measuring current	39
6.5 Setting the desired current.....	40
6.6 Finding pick-up and drop-out limits for over current/voltage/other entity relays	41
6.7 Finding pick-up and drop-out limits for under current/voltage/other entity relays..	42
6.8 Measuring operating times for over current/voltage/other entity relays	43
6.9 Measuring operating times for under (current/voltage/other entity) relays	44
6.10 Measuring voltage	44

6.11 Obtaining the correct phase angle when two or more AC outputs are being used	45
6.12 Generating higher voltages	45
6.13 Setting an auxiliary voltage	46
6.14 Testing voltage relays – both pre-fault and fault voltages	46
6.15 Changing the current and voltage phase difference	47
SVERKER 750	47
SVERKER 780	47
6.16 Measuring the phase angle	48
6.17 Measuring external cycle time (measurement not initiated by SVERKER)	49
6.18 Measuring Z, P, R, X, VA, VAR and COS ϕ	49
6.19 Plotting a magnetization curve	50
6.20 Testing an automatic recloser	50
6.21 Measuring the trip pulse length	51
6.22 Injecting current – External start	52
7 Application examples	54
7.1 Testing voltage relays	54
7.2 Testing over-current relays	55
7.3 Testing directional over-current relay systems or directional ground-fault (earth-fault) relay systems	57
SVERKER 780	57
SVERKER 750	58
7.4 Testing power relays	60
7.5 Testing undervoltage relays	61
Test hook-up and initial settings	61
7.6 Testing motor overload releases and overcurrent cut-outs that grant/deny starting permission	63
7.7 Testing frequency relays	63
8 Troubleshooting	64
8.1 General	64
8.2 Displayed values	64
8.3 Error messages etc.	65
9 Specifications	66
Specifications extended	67
Maximum load times for different currents	67

The voltage outputs of the current source	67
Separate AC voltage source	67
Auxiliary DC voltage output	67
Inputs	68
Make/Break contact	68
Measurement section	68
Extra measurements	69
Other	69

Index	72
--------------	-----------

1 Safety

Symbols on the instrument



Caution, refer to accompanying documents.



Protective conductor terminal.



WEEE, Waste Electrical and Electronic Equipment. Please utilize your local WEEE collection facilities in the disposition of this product and otherwise observe all applicable requirements.

Information duty regarding substances on REACH article 33, SVHC-list

This product contains a coin cell battery which contains 1,2- dimethoxyethane (CAS 110-71-4) above 0.1% by weight.

Safety instructions



Important

Read and comply with the following instructions.

Always comply with local safety regulations..



Warning

First of all, connect protective earth (ground). Use the green/yellow cable.

Never connect the SVERKER 750/780 to an external voltage if the protective earth (ground) is not connected.

Always use safety connecting leads.

Always turn the SVERKER 750/780 off before connecting.

Generated voltages and currents may be harmful to the operator or the device under test.

The SVERKER 750/780 should be operated only from the type of power source indicated on its nameplate.

The SVERKER 750/780 is equipped with a mains plug having a third (earthing, grounding) pin. This plug will only fit into an earthing/grounding-type power outlet.

The SVERKER 750/780 must not be used in other ways than stated by the manufacturer.

Never spill water or other liquid of any kind on the SVERKER 750/780.

Unplug the SVERKER 750/780 from the wall outlet before cleaning. Use a damp cloth for cleaning. Do not use liquid cleaners or aerosol cleaners.

Do not use auxiliary equipment not

recommended by the SVERKER 750/780 manufacturer since this may cause hazards.

Do not attempt to service the SVERKER 750/780 yourself. Opening or removing covers may expose you to dangerous voltage and other hazards.



Important

For added protection during a lightning storm, or when the SVERKER 750/780 is left unattended and unused for long periods of time, unplug it from the wall outlet. This will prevent damage due to lightning and power line surges.

The maximum load times depends on the used current value, see chapter 9 under Specifications extended.

If, for some reason, you need to return your SVERKER 750/780, please use either the original transport box or one of equivalent strength.

2 Introduction

2.1 Applications

SVERKER 750/780 is intended primarily for testing relay protection equipment, but it can also be used for many other purposes. Virtually all single-phase relay protection equipment can be tested, and SVERKER 750/780 can also test three-phase relay protection equipment that can be tested phase by phase. Moreover, many relay protection systems that require phase shifting can be tested.

Items that can be tested using SVERKER 750/780 include:

Type of relay	ANSI standard code
Overcurrent relay	50
Inverse time overcurrent relay	51
Undercurrent relay	37
Ground fault relay	50N, 51N
Directional overcurrent relay	67
Directional ground fault relay	67N
Overvoltage relay	59
Undervoltage relay	27
Directional power relay	32
Power factor relay	55
Differential protection (differential circuit)	87
Distance protection equipment (phase by phase)	21
Negative sequence overcurrent relay	46
Motor overload protection	51/66
Automatic reclosing devices	79
Tripping relay	94
Voltage regulating relay	
Underimpedance relay	21
Thermal relay	49
Time-delay relay	
Frequency relay (SVERKER 780)	81

Other applications

- Plotting excitation curves
- Current and voltage transformation ratio tests
- Burden measurement for relay protection equipment
- Impedance measurement
- Efficiency tests
- Polarity (direction) tests

2.2 Design and construction

The current source built into SVERKER can provide 0-10 A, 0-40 A, 0-100 A, 0-250 V AC or 0-300 V DC. Timing and generation (output) can be carried out simultaneously. When the relay protection equipment trips, both output and timing are interrupted.

Note *The current output depends on the burden of the relay (circuit). This means that it is possible to get high output currents, over the maximum measurement range of 250 A.*

There is also a separate built-in AC voltage source to supply the relay voltage input.

A 20-220 V DC voltage source is used to provide auxiliary voltage.

The quality of the output signal is depending on the quality of the input voltage. If the main voltage is distorted the output signal will also be distorted. However, the AC voltage source in SVERKER 780 is fully synthesized by the instruments itself and therefore independent of the mains input voltage.

SVERKER is equipped with a timer, ammeter and voltmeter, and these instruments can also be used to indicate resistance, impedance, phase angle, power and power factor. Moreover, these instruments can be used for measurements in external circuits.

A set of resistors and a capacitor (SVERKER 750) are provided, and they can be connected into the circuits being tested to provide phase shifts, fine adjustments and the like.

A make/break contact can be used to synchronize other circuits with tests that are being conducted.

SVERKER settings are made using knobs and other controls on the control panel. Numerous other settings can be made via the display window built into the control panel.

3 Description

3.1 General

This chapter presents a general description of SVERKER and the types of functions it performs. For more detailed descriptions, please see Chapters 4 and 5.

SVERKER 750 control panel

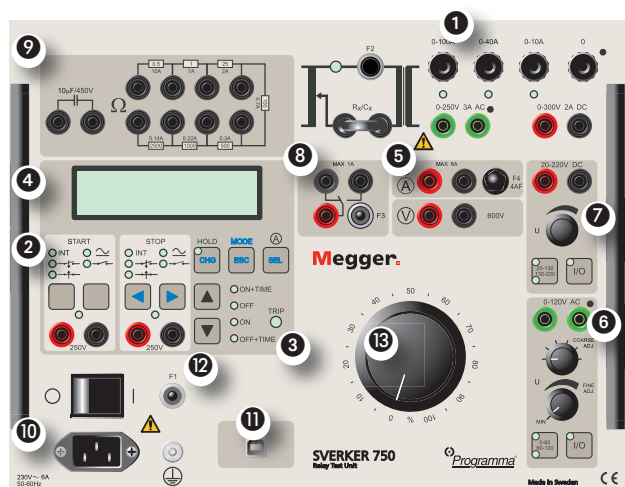

1	Current source
2	Timer
3	Trip indicator
4	Display
5	Ammeter & voltmeter
6	AC voltage source
7	Auxiliary voltage source
8	Make/Break contact
9	Resistor set and capacitor
10	Power supply
11	Computer interface
12	Start switch
13	Main knob

SVERKER 780 control panel

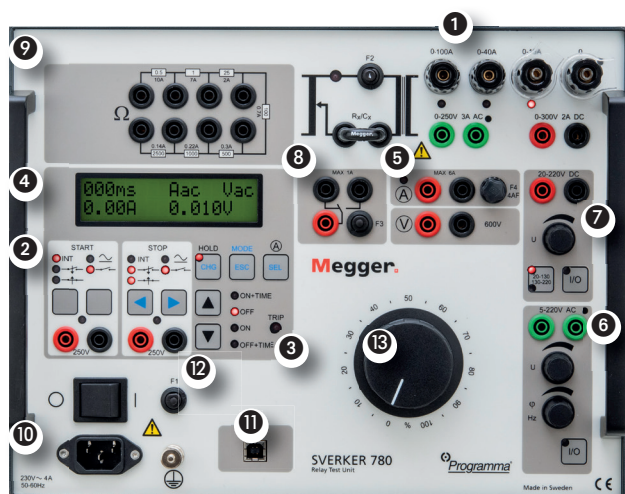

3.2 Current source

The main source built into SVERKER can provide 0–100 A, 0–40 A, 0–10 A, 0–250 V AC or 0–300 V DC, depending on which output is used. As a rule, this current source is used to provide simulated sudden–change fault conditions for the object being tested.

Values are set using the main knob on the control panel. Current, voltage and other settings appear on the display. See section headed “Ammeter and voltmeter”.

Generation is turned on and off using the start switch which has four positions

Indication	State	Used to
ON+TIME	Current source is activated until the object being tested has operated. The time is then displayed, whereupon SVERKER returns automatically to the OFF mode*.	Measure operating times for over-current/voltage/other entity relays.
OFF	Current source is turned off.	Turn off the current source.
ON	Current source is turned on (activated).	Make settings and find pick-up / drop-out limits.
OFF+TIME	Current source is turned off. When the object being tested has operated, the time is displayed, whereupon SVERKER returns automatically to the OFF mode.	Measure operating times for under-current/voltage/other entity relays.
*) When trip occurs, generation is interrupted after a number of mains cycles. This delay simulates the circuit breaker's breaking time. The length of delay can be set by the user.		

An indicator lamp to the right of the set of resistors is lighted during generation. Generation start-up is synchronized with the mains, thus eliminating inaccuracies in the test results attributable to the instant at which the start switch is activated.

There are a number of different types of generation, and they are selected via the display window (Chapter 5)

Type of generation	Explanation
Generation that continues until the object being tested trips	Generation continues until the timer stops.
Momentary (manually-controlled) generation	This permits the user to provide brief, manually-controlled generation that is interrupted immediately when the start switch is released.

Time-limited generation	Here, you can set a maximum time for generation. When it expires, generation is interrupted immediately.
Restarted generation (used to test automatic reclosing devices)	You can set the SVERKER so that generation will be restarted (start again) when the timer start input is activated. This feature is used to test automatic reclosing devices.

3.3 Timer

Since the timer has a start input and a stop input, it can be used to measure external cycles as well as sequences initiated by SVERKER. The measured time appears in the display window.

To test automatic reclosing devices, SVERKER is able to measure a number of sequential time intervals and display the results later.



The inputs can be set individually to respond either to zero-potential contact operation or to a voltage (AC or DC).

Input state indicators

At each timer START and STOP input there is an input state indicator lamp that indicates the state of the input. When the indicator lamp is lighted, it indicates either a closed circuit (for contact mode) or the presence of a voltage (for voltage mode). These indicators permit you to (for example) check the circuits involved before starting a test sequence.

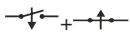

Start conditions

The timer can be started in the following ways:

Indication	Start condition
INT	a) When an internal start occurs, i.e. for a test sequence started by SVERKER (ON+TIME or OFF+TIME).
	b) When a voltage is applied to the start input or when a contact is closed.
	c) When a voltage applied to the start input vanishes or when a contact is opened
	d) When the state of the input changes.

Stop conditions

The timer can be stopped in the following ways:

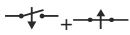
Indication	Stop condition
INT	a) When an outgoing current is interrupted (internal detection).
	b) When a voltage is applied to the stop input or when a contact is closed.
	c) When a voltage applied to the stop input vanishes or when a contact is opened.
	d) When the state of the input changes.

Measuring an external cycle

Before measuring, SVERKER must be set to the ON+TIME state, whereupon the timer will also be cleared to zero.

Clearing the timer

The timer will be cleared to zero when generation starts again.

Testing automatic reclosing devices

A setting must be made via the display window before you can test automatic reclosing devices. ON+TIME is lighted throughout the entire cycle. Generation starts again each time the timer's start input is activated.

3.4 Trip indicator

When the stop condition is met, the TRIP indicator is lighted. This lamp indicates tripping of the relay protection equipment. When a test includes timing, this indicator lamp flashes when tripping occurs.

3.5 Display

Current, voltage and other entities can be shown on the display.

The display window is also used to make settings. To do this, you must put SVERKER in the setting mode by pressing the button marked MODE.

3.6 Ammeter & voltmeter

SVERKER is equipped with an ammeter and voltmeter. These instruments can also be used to display resistance, impedance, phase angle, power and power factor. Moreover, these instruments can be used to perform measurements in external circuits. In both cases, the values appear on the display.

The ammeter measures one of the following:

- Current at one of the current outputs 0-100 A, 0-40 A or 0-10 A.
- Current in an external circuit connected to the SVERKER 750/760 ammeter panel input (marked $\text{\textcircled{A}}$).

You select the desired measurement site (test point) using the button marked A, whereupon a indicator lamp lights at the selected measurement site.

The voltmeter shows the voltage connected to the voltmeter input (marked V) on the panel. This input is always activated.

The ammeter and voltmeter both change ranges automatically, but they can also be changed manually. For AC, they measure true RMS value. You can change from AC to DC and vice versa.

Note *When using AUTO RANGE the measured value can be totally wrong. This can happen when a previous value was in another range than the present value. Set the correct range (see section 9.5) and/or repeat the same test again.*

A HOLD (freeze) function permits you to measure voltages and currents having duration as short as a quarter of the mains cycle. When the timer is stopped, the current and voltage values are frozen. If the timer is not stopped, the values present when the current was interrupted are frozen. The hold function is engaged by pressing the button marked HOLD. - - - can sometimes appear during measurement of high-speed AC cycles when the hold function is invoked. This means that no value could be presented because the cycle was too short.

If O.F. (means overflow, i.e. a value beyond the measurement range) appears, the cycle being measured may have been so fast that there wasn't time for automatic range changing. In such case, you should repeat the measurement. The range-changing system is memory-equipped, and repeating your measurement may give it time to make the change properly.

When current and/or voltage fluctuate widely, a filter can be engaged to make reading easier. The filter performs an averaging function.

Instead of having current and voltage shown in amperes and volts, you can have them shown as a percentage of a given current or voltage (the relay protection equipment's setting for example). A flashing current value means that the value is less than 1% of the range being used. To get a more accurate current reading, you can then measure via the ammeter input.

3.7 AC Voltage source

SVERKER 750

The AC voltage source provides 0-120 V AC (split into two ranges). It has two knobs of its own, one for rough and one for fine settings. Since the AC voltage source is separated from other outputs, it is set independently of the current source.

The AC voltage source is intended primarily for the relay protection equipment's voltage input. A set of resistors and a capacitor can be used to change the phase angle of the current and the voltage.

SVERKER 780

The AC voltage source provides 5-220 V AC with adjustable phase-angle and frequency. Since the AC voltage source is separated from other outputs, it is set independently of the current source.

The generated waveform is independent from the mains AC supply as it is internally synthesized by the SVERKER 780.

The AC voltage source is intended primarily for the relay protection equipment's voltage input.

Note *For correct RMS readings the Ammeter/Voltmeter is automatically set to the mains frequency at start up. When the AC voltage source is switched on and "Frequency" has been selected as an additional measurement parameter the sampling interval of the Ammeter/Voltmeter is automatically set to measure correctly at the selected frequency of the AC voltage source.*

In order to supply an accurate measurement for other frequencies than 50/60 Hz it is necessary to do the following adjustment.

- 1] Turn on the independent AC voltage output.
- 2] Enter the measurement menu and select Frequency (U).
- 3] Exit the menu.
- 4] Adjust to the desired frequency.

Note *As long as the AC voltage output is turned on the selected frequency is used for voltage and current measurement. If turned off the measurement returns to 50/60 Hz.*

3.8 Auxiliary voltage source

The auxiliary voltage source provides 20-220 V DC (split into two ranges). It is equipped with overcurrent protection, and it is separate from the other outputs. Moreover, it can be used to supply the relay being tested.

3.9 Make/Break contact

There is a make/break contact that is actuated when SVERKER is set to the ON+TIME or OFF+TIME state. It can be used, for example, to synchronize other equipment or to change the voltage supplied to the relay protection equipment at the start of a test from non-faulty to faulty or vice versa.

3.10 Resistor set and capacitor

The resistor set and capacitor can be used to change the phase angle of the current and voltage.

Note *There is no capacitor on the SVERKER 780.
The phase-angle is set with the knob at the AC voltage source.*

3.11 Power supply

The power supply is equipped with a miniature circuit breaker.

3.12 Computer interface

SVERKER has a serial port for communication with computers and the SVERKER Win software.

To be able to use the SVERKER 750/780 with the software SVERKER Win the SVERKER 750/780 must be "unlocked" with a software key. You can check if your SVERKER is "unlocked" by doing the following.

- 1] Press "MODE".
- 2] Press ▼ until you get to the bottom where the SW-version is displayed. If the text "PC-750" or "SVERKER WIN" is shown the SVERKER is "unlocked".

If the text is not shown you must order the software key for SVERKER Win, (Art. No: CD-81000). When ordering you must mention the serial number of the SVERKER 750/780.

4 Control panels

4.1 Front panels

SVERKER 750

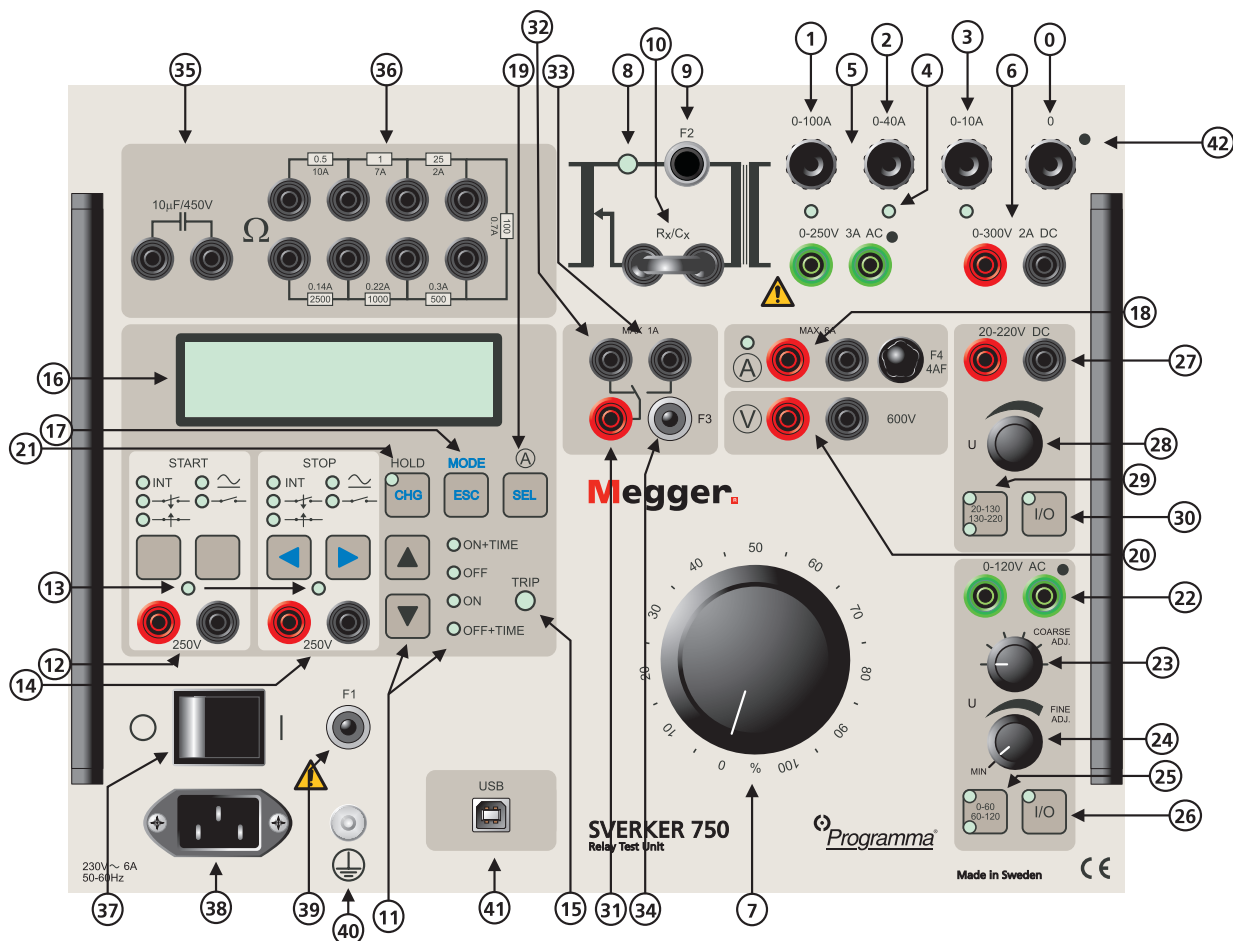

SVERKER 780

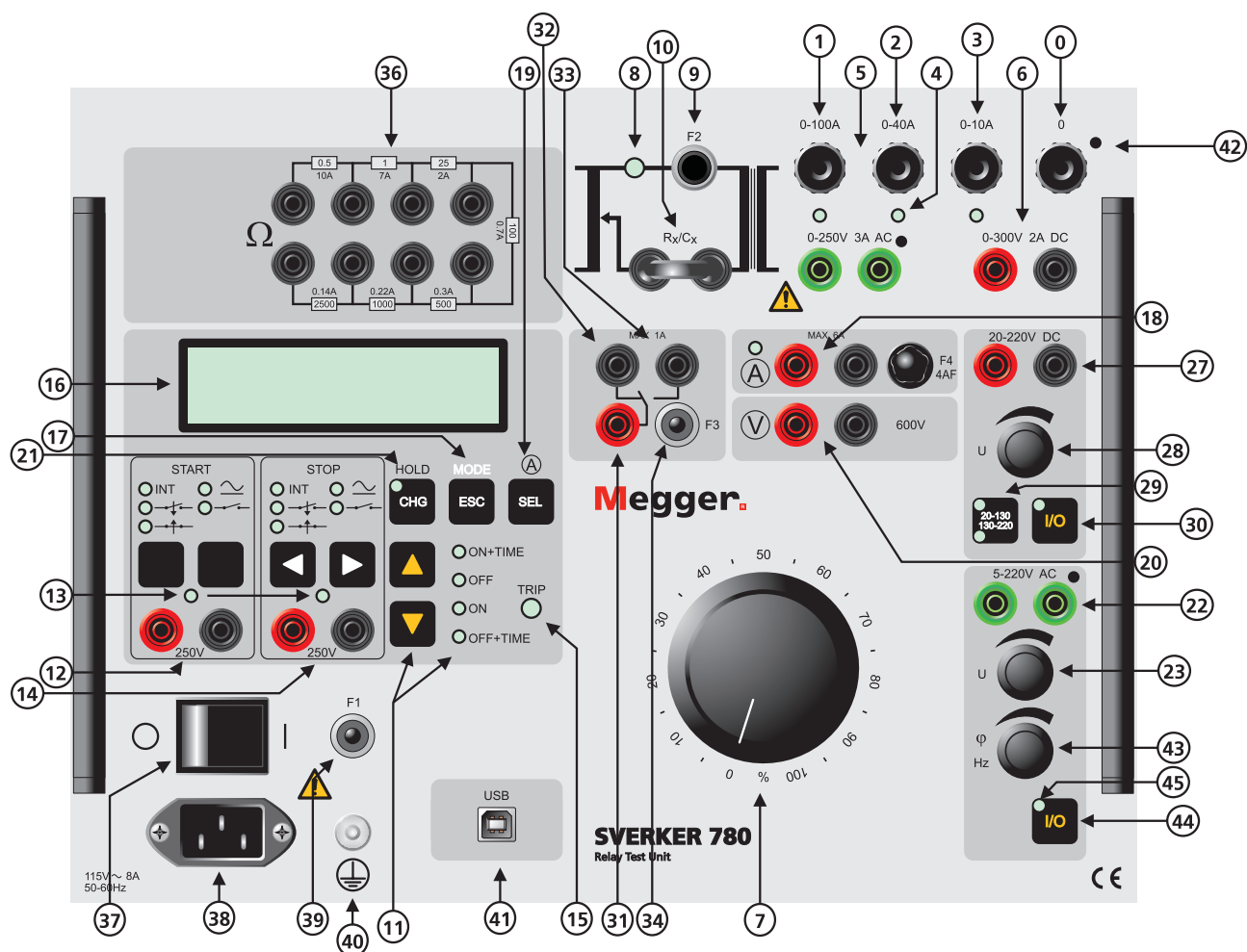

4.2 Current source

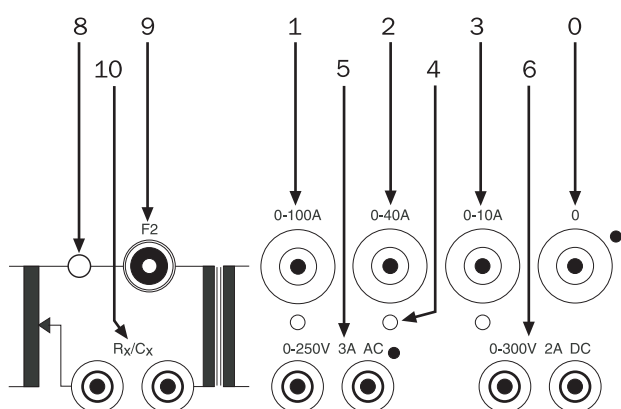

0	Neutral	For current sources.
1	0-100 A current output	Regulated with main knob (7).
2	0-40 A current output	Regulated with main knob (7).
3	0-10 A current output	Regulated with main knob (7).
4	Indicator lamp, ammeter test point	When this indicator lamp is lighted, SVERKER is measuring current at the associated output. To change the measurement site, press the button marked A (item 19).
5.	0-250 V, 3 A, AC	AC voltage is variable from 0 to 250 V. Regulated with main knob 7.
6.	0-300 V, 2 A, DC	DC voltage is variable from 0 to 300 V. Regulated with main knob 7.
7.	Main knob	Used to regulate the current source (outputs 1, 2, 3, 5 and 6).
8.	Indicator lamp	When this indicator lamp is lighted, the current source is activated (outputs 1, 2, 3, 5 and 6).
9.	F2	Miniature circuit breaker for the current source. 4 A (230 V), 8 A (115 V).
10.	Rx/Cx	Connector for resistor or capacitor. To obtain a smoother characteristic, connect one or more resistors in series. To change the phase angle 90° (on SVERKER 750), connect the capacitor. Note: A jumper must be connected to this connector when it is not being used.
11.	Start switch	Turns the current source on and off. Use the ▲ and ▼ buttons to select the desired mode.

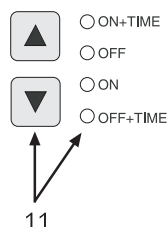

OFF	Current source is turned off.
ON	Current source is turned on (activated).
OFF+TIME	Current source is turned off. When the object being tested has operated, the time is displayed, whereupon SVERKER returns automatically to the OFF mode.

Button	Function
▲	Lights the next higher indicator lamp (one step up).
▲ in setting mode (MODE activated)	Moves up in the menu or increases the value.
▼	Lights the next lower indicator lamp (one step down).
▼ in setting mode (MODE activated)	Moves down in the menu or decreases the value

Indication	What is meant
ON+TIME	Current source is activated until the object being tested has operated. The time is then displayed, whereupon SVERKER returns automatically to the OFF mode.

4.3 Timer

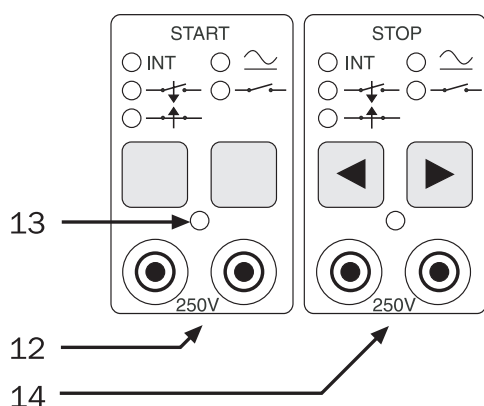

12.	START input	This is used to start the timer. Max 250 V (AC or DC). The time is shown in the display
-----	-------------	---

Indication	Condition required for timer start
INT	a) Internal. Used when ON+TIME or OFF+TIME is selected.
	b) When voltage is applied or when a contact is closed.
	c) When applied voltage vanishes or when contact is opened.
	d) When the state of the input changes.

Select the desired option using the left most of the two blank-faced buttons located under START on the control panel.

Indication	Mode
	Voltage mode. Detects if voltage is applied or not.
	Contact mode. Detects if circuit is closed or not.

Select either the voltage mode or the contact mode using the right most of the two blank-faced buttons located under START on the control panel.

13.	Indicator lamp	This lamp indicates the state of the timer input. When this indicator lamp is lighted voltage is present at the input (voltage mode) or the circuit is closed (contact mode).
14.	STOP input	This is used to stop the timer. Max 250 V (AC or DC). The time is shown in the display.

Indication	Condition required for timer stop
INT	a) Internal. Used when ON+TIME or OFF+TIME is selected.
	b) When voltage is applied or when a contact is closed.
	c) When applied voltage vanishes or when contact is opened.
	d) When the state of the input changes.

Select the desired option using the ← button (blue). It is the left most of the two buttons located under STOP on the control panel.

In the setting mode (MODE activated): The ← button provides a move to the left on the display.

Indication	Mode
	Voltage mode. Detects if voltage is applied or not.
	Contact mode. Detects if circuit is closed or not.

Select either the voltage mode or the contact mode using the ► button (blue). It is the right most of the two buttons beneath STOP on the control panel.

In the setting mode (MODE activated): The ► button provides a move to the right on the display.

4.4 Trip indicator

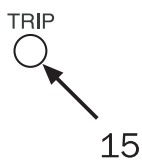

15.	TRIP indicator	This indicates that the object being tested has tripped. The fact that tripping occurred indicates that the conditions imposed at the timer's stop input (item 14) are met. This indication does not occur unless the object being tested is connected to the stop input.
-----	----------------	---

- A] Steadily glowing indicator lamp:**
Indicates tripping when the test is being conducted without timing (start switch at the ON position).
- B] Flashing indicator lamp:**
Indicates tripping when the test is being conducted with timing (start switch at the ON+TIME or OFF+TIME position). It also indicates that timing is completed. SVERKER then returns automatically to the OFF state. You can reset the flashing indicator lamp by pressing the button marked HOLD (item 21) twice.

4.5 Display

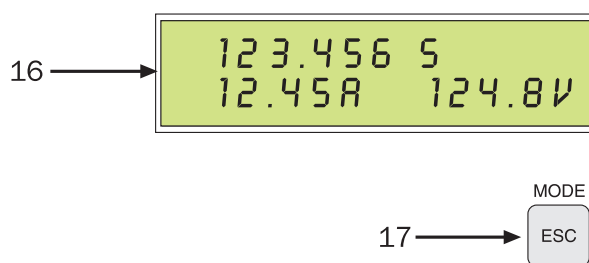

16.	Display	
17.	MODE button	This button changes the display from the measurement mode (normal mode) to the setting mode and vice versa.

Note *In the setting mode (MODE activated): The ESC (blue text) button leaves the present menu option unchanged and proceeds to the next higher menu option.*

4.6 Ammeter & voltmeter

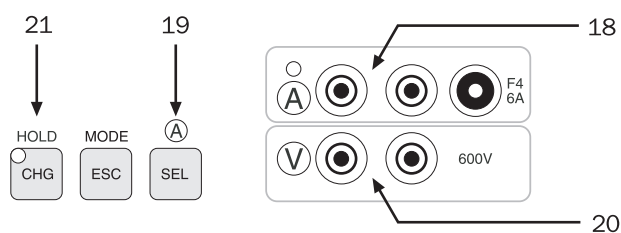

18.	Input marked A	This is the external panel input to the SVERKER ammeter. It is activated by pressing the button marked A (item 19) which is located at right beneath the display window. The indicator lamp adjacent to this input is lighted to indicate that the input is activated. F4 6 A: Miniature circuit breaker for the ammeter.
19.	Button marked A	This button is used to transfer the ammeter test point to current outputs 1, 2, 3 or to select the external panel input to the SVERKER ammeter (item 18). The current value is shown on the display. Note: <i>In the setting mode (MODE activated): The SEL (blue text) button selects the menu option that is displayed.</i>
20.	Input marked V	This is the input to the SVERKER voltmeter, and it is always activated. The voltage value is shown on the display.
21.	Button marked HOLD	This button freezes the prevailing current and voltage values when the object being tested is tripped or when generation stops. If tripping does not occur, the prevailing value is frozen when SVERKER changes to the OFF state. The hold (freeze) function is toggled on and off by pressing this button When you turn the hold function off, the flashing trip indicator 15 is reset. Moreover, SVERKER senses the state of timer stop input 14 (STOP), thus making it possible to respond if a change occurs at this input. This is valid only while the input is in change sensing state (b + c, see item 14).

Note *In the setting mode (MODE activated): The CHG (blue text) button opens the displayed menu option so that it can be changed.*

CHG, ESC and SEL are imprinted on the faces of the buttons marked HOLD, MODE and A respectively. These imprints (CHG, ESC and SEL) apply only when SVERKER is in the setting mode. The panel markings (HOLD, MODE and A) apply when SVERKER is in its normal mode, i.e. the measurement mode.

4.7 AC Voltage source

SVERKER 750

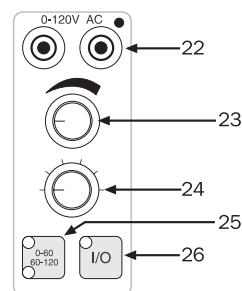

22.	0-120 V AC	Separate, independent output for AC voltage. Can be varied from 0 to 120 V using knobs (23) and (24).
23.	Knob	For fine adjustment of AC voltage (22).
24.	Knob	For rough adjustment of AC voltage (22).
25.	0-60, 60-120	This is used to toggle between the 0-60 V and 60-120 V AC voltage ranges.
26.	I/O. ON/OFF switch	For the AC voltage source.

SVERKER 780

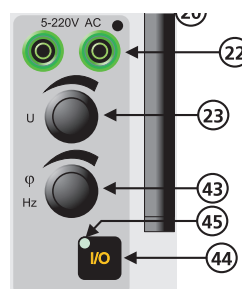

22.	5-220 V AC	Separate, independent output for AC voltage.
23.	Knob	For setting the AC amplitude.
43.	Knob	For adjustment of the phase-angle or frequency. Turning the knob in Phase mode will adjust the phase angle by 10° or 1°. Press the knob to swap between coarse and fine steps. Turning the knob in Frequency mode will adjust frequency by 10 Hz, 1 Hz, 0.1 Hz or 0.001 Hz. Press the knob to swap between the steps. The selected step is shown at the display.
44.	I/O. ON/OFF switch	For the AC voltage source.
45.	LED	Blinks if error is detected.

4.8 Auxiliary voltage source

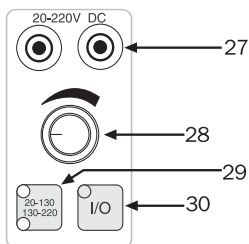

27.	20-220 V DC	Separate, independent output for auxiliary voltage (DC) to the object being tested. Can be varied from 20 to 220 V DC using knob (28).
28.	Knob	For auxiliary voltage (27).
29.	20-130 / 130-220 switch	This is used to toggle between the 20-130 V and 130-220 V DC auxiliary voltage ranges.
30.	I/O. ON/OFF switch	For the auxiliary voltage source (27).

4.9 Make/Break contact

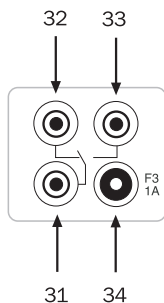

31.	Relay contact	Changes state in response to ON+TIME and OFF+TIME. Note: Contact switching also takes place when SVERKER is set to "Reclose" mode. The sequence starts with the contact in position (33).
32.	Break	(normally-closed) function.
33.	Make	(normally-open) function.
34.	F3 1 A	Miniature circuit breaker for relay contact (31).

4.10 Resistor set and capacitor

SVERKER 750

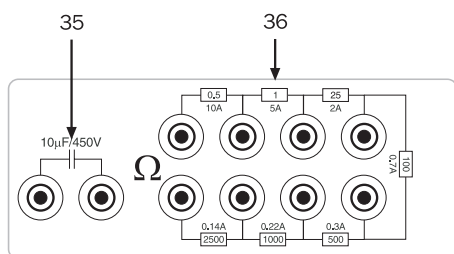

35.	Capacitor	10 mF, 450 V
36.	Resistor set	

SVERKER 780

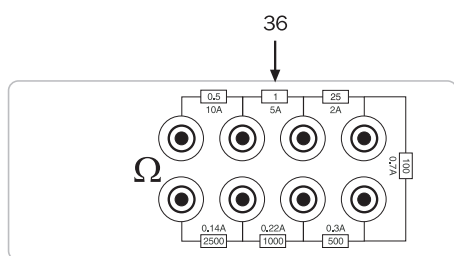

36.	Resistor set	
-----	--------------	--

4.11 Power supply

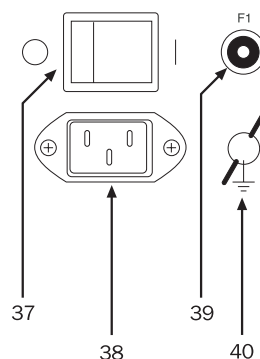

37.	Mains voltage	ON/OFF.
38.	Connector	For mains voltage.
39.	F1	Miniature circuit breaker for the power supply. 4 A (230 V), 8 A (115 V).
40.	Ground	(earth) terminal

4.12 Other

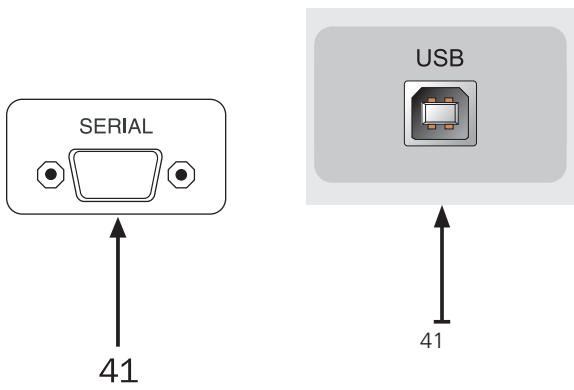

41.	SERIAL or USB	Serial port for communication with computers and the SVERKER Win software.
-----	---------------	--

Note *A driver for the USB port must be installed before you can use the USB port. The USB driver is in the SVERKER Win software.*



42.	Black dot	Terminals marked with black dots all have the same polarity (used for AC voltage sources).
-----	-----------	--

5 Making settings on the display

5.1 Introduction

There are a number of ways to make SVERKER settings. In addition to using the buttons and other controls on the control panel, you can make settings via a menu shown on the display. To proceed via this menu, however, you must first put SVERKER in the setting mode.

How to enter the setting mode

Before you can change from the measurement mode (normal mode) to the setting mode, SVERKER must be in the OFF state. To enter the setting mode, you press the button marked MODE.

Display shown in the setting mode

When SVERKER is in the setting mode, two lines appear in the window. The menu heading appears on the first line, and the selected menu option appears on the second line between < and > characters.

```
Menu heading
<Menu option>
```

Memories – Your default settings and the original SVERKER settings

You can save settings that have been made via a menu. This can be useful when, for example, you want to prepare settings in advance to make it easier to test different types of protective relay equipment. Saved settings remain in the memory even after the SVERKER has been turned off. Since ten memories are available for this purpose, you can save settings for up to ten different types of protective relay equipment.

Each time SVERKER is turned on, the settings in memory No. 0 are recalled as defaults. Your default settings, i.e. the settings you want to recall automatically at turn-on time should thus be saved in memory No. 0.

To save something in or recall something from a memory you proceed via the Save/Recall menu option. See section 5.13.

In addition, there is a special memory that contains the original SVERKER settings. These can be recalled whenever you want to use them. The original settings are kept in the special memory. They are determined by Megger, and you cannot change them.

How to return to the measurement (normal) mode

You can return from the setting mode to the measurement mode at any time by pressing the ESC button. Note, however, that you may sometimes have to press this button twice, depending on where you are in the menu.

5.2 Button functions

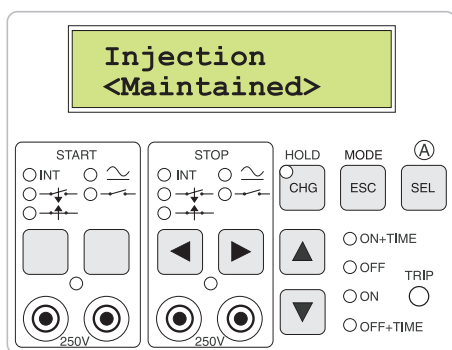

Button	Function in setting mode (MODE activated)
CHG	Opens a menu option so that it can be changed. If a numeric value is to be changed, a cursor appears which can be moved by pressing the ◀ button or ▶ button.
ESC	Leaves the menu option unchanged and moves to menu level 1. If you are already on menu level 1, pressing ESC causes SVERKER to leave the setting mode.
SEL	Invokes the menu option that has been selected.
▲	Moves up in menu or increases a numerical value.
▼	Moves down in menu or decreases a numerical value.
▶	Moves right in display window.
◀	Moves left in display window.

5.3 Direction indicator

In addition to the menu heading and menu option, a direction indicator appears on the display. It indicates the direction(s) in which you can move in the menu or change a numerical value. The direction indicator can have one of three shapes: diamond (double up/down arrow), up arrow or down arrow.

Direction indicator ↓

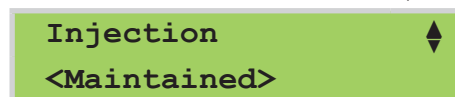

Direction indicator shapes and their meanings

Indicator shape	Meaning
◄ Up and down arrow	You can move either up or down (or increase/decrease a value).
▲ Up arrow	You can only move up (or increase a value).
▼ Down arrow	You can only move down (or decrease a value).

How to change a numerical value

Some menu options include numerical values (settings) that can be changed.

- To open a numerical value for change, you press the CHG button, whereupon a cursor appears beneath the right most digit.
- You can now move the cursor with the ◀ or ▶ button until it is beneath the desired digit. Then increase or decrease the value using the ▲ or ▼ button.

Example:

If you want to change 99.9 to 95.0 you press the CHG button to open the numerical value for change.

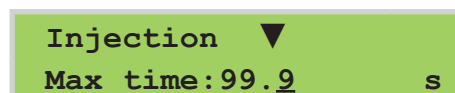

A cursor that indicates which digit can be changed appears beneath the right most digit.



Press the ▼ button nine times to step from 99.9 down to 99.0, and then move it one step to the left by pressing the ◀ button.



Press the ▼ button four times to step from 99.0 down to 95.0. The numerical value is now set as desired, but to invoke it you must press the SEL button.

5.4 The menu system

Menu level 1	Menu level 2 options	Explanation
Test mode	Normal	Measures time from START to STOP.
	Trip + pulse time	Measures time from START to STOP and also the duration of the trip pulse.
	Reclose: #01 999 s	Sets time for reclosing. Max 49 reclosings. The total time for the specified number of reclosings can range from 001 to 999 s.
Injection	Maintained	Generation continues without time limit.
	Momentary	Generation continues while button is kept pressed.
	Max time 99.9 s	Generation continues throughout a preset interval that can range from 00.1 s to 99.9 s.
	External start	See section 5.6
Ammeter	AC	Measures AC, true RMS.
	DC	Measures DC, mean value.
	Unit: Ampere	Expressed in amperes.
	Unit: % of nom I	Expressed as % of nominal current.
	Nom I: 001 A	Used to set nominal current.
	Range: Auto	Range selected automatically.
	Range: Low	Fixed low range.
Range: High	Fixed high range.	
Voltmeter	AC	Measures AC, true RMS
	DC	Measures DC, mean value
	Shunt (1–999 mΩ)	Default shunt value is 100 mΩ. Displayed value is shown in A or kA.
	Unit: Volt	Expressed in volts.
	Unit: % of nom U	Expressed as % of nominal voltage.
	Nom U: 063 v	Used to set nominal voltage.
	Range: Auto	Range selected automatically.
	Range: Low	Fixed low range.
	Range: Mid	Fixed mid range.
	Range: High	Fixed high range.

Menu level 1	Menu level 2 options	Explanation
Q , φ , W , VA	None	No extra measurement function displayed
	Z (Ω, φ)	Impedance (magnitude + phase angle)
	Z (Ω)	Impedance (magnitude)
	R, X (Ω, Ω)	Resistance and reactance (magnitude and magnitude)
	P (W)	Active power
	S (VA)	Apparent power.
	Q (VAR)	Reactive power.
	cos φ	Power factor.
	φ (°, Iref)	Phase difference, current as reference.
	φ (°, Uref)	Phase difference, voltage as reference.
	Frequency (U)	Frequency
Timer	Unit: Seconds	Time expressed in seconds.
	Unit: Cycles	Time expressed in mains-frequency cycles.
Display	Slow	Average-value filter enabled, thereby stabilizing the display. 10 values are used to create the average. Phase difference is not filtered. Only for measurement purpose, not to be used for time test.
	Fast	Average-value filter disabled. Used always as default for time test.
	Hold Trip	Shows the max value in RMS for 1 period immediately before tripping.
	Hold Max	Shows the max value in RMS for 1 period within the last 0.5 s held in memory.
	Hold Min	Shows the min value in RMS for 1 period within the last 0.5 s held in memory.
	Off delay	Cycles 004
0-Level filter	1-9	To avoid measuring noise that can be encountered during testing. A 0-level of 1 (min.) allows low-level signals to pass. A 0-level of 9 (max.) filters out most noise.

Menu level 1	Menu level 2 options	Explanation
Save/Recall	Recall mem #: 0	Recalls all settings that were stored in the specified memory. Range is 0 – 3.
	Recall default	Recalls all of the original settings made by Megger prior to delivery (they are stored in a special memory).
	Save mem #: 0	Saves the settings in the specified memory. The range is 0-3.
Remote control	ON	Settings are controlled from SVERKER Win. This will be set automatically when Starting SVERKER Win.
	OFF	SVERKER is controlled from the panel.
Language	English	English language menus, prompts etc.
	Deutsch	German language menus, prompts etc.
	Français	French language menus, prompts etc.
	Espanol	Spanish language menus, prompts etc.
	Svenska	Swedish language menus, prompts etc.
	čeština	Czech language menus, prompts etc.
	Türk	Turkish language menus, prompts etc.
SW: R04E "PC-750" or "SVERKER Win"		Software version. The SVERKER is "unlocked" and ready to be used with SVERKER Win (or ProView PC750

5.5 Test mode

Test mode

<Normal>

This menu option is used to specify the desired type of time measurement. You have three choices: Normal, Trip + pulse time and Reclose.

Menu option	Explanation
Normal	Measures time from START to STOP.
Trip + pulse time	Measures time from START to STOP and also the duration of the trip pulse.
Reclose: #01 999 s	Sets time for reclosings. Max 49 reclosings. The total time for the specified number of reclosings can range from 1 to 999 s.

- 1] You press the CHG button to access the different memory options, and then scroll up or down using the ▲ or ▼ button.
- 2] Press the SEL button to invoke the selected option.

5.6 Injection

Injection
<Maintained>

Here, you select the type of generation. You have four choices: Maintained, Momentary, Max time and External Start.

Menu option	Explanation
Maintained	Generation continues without any time limit.
Momentary	Generation continues while start switch is kept activated.
Max time: 99.9 s	Generation continues throughout a preset interval that can be set from 00.1 to 99.9 s. Note: To change a numerical value, press the CHG button one additional time and then use the arrow buttons.
External Start	Select dry or wet contact and closing or opening contact for the external signal. This feature enables you to start two or more SVERKERs simultaneously. The SVERKERs "slaves" can be connected to the make/break contact on the SVERKER "master" and then be set for external start. The slaves will start at the same time as the master (± 1 ms).

- 1] Press the SEL button to invoke the selected option.

5.7 Ammeter

Ammeter
<AC Amp Auto>

This option is used to make settings for the SVERKER ammeter.

The ammeter can be set to measure AC or DC. AC readings are expressed as true RMS values while DC readings are mean values.

Readings can be expressed in amperes or percentages of the nominal current (which can be set from 1 to 999 A). These choices are called units in the menu.

Note To change a numerical value, you press the CHG button one additional time and then use the arrow buttons.

The range can be set to Auto or to Fixed low or Fixed high. The fixed ranges are useful for short measurement cycles during which the ammeter doesn't have time to change range automatically. If this occurs, O.F. (range overflow) is displayed constantly.

For more information about the different ranges see chapter 9, headed Specifications.

Menu option	Alternative	Explanation
AC	Alt. 1	Ammeter measures AC as true RMS.
DC	Alt. 2	Ammeter measures DC as mean value.
Unit: Ampere	Alt. 1.	Current is shown in amperes.
Unit: % of nom I	Alt. 2.	Current is shown as % of the nominal current which can range from 1 to 999 A.
Nom I: 001 A	—	Nominal current setting
Range: Auto	Alt. 1.	Range selected automatically
Range: Low	Alt. 2.	Fixed low range
Range: High	Alt. 3.	Fixed high rang

- 1] Press the SEL button to invoke the selected option.

5.8 Voltmeter

Voltmeter

<AC Volt Auto>

This option is used to make settings for the SVERKER voltmeter.

The voltmeter can be set to measure AC or DC. AC readings are expressed as true RMS values while DC readings are mean values.

Readings can be expressed in volts or percentages of nominal voltage (which can be set from 1 to 999 V). These choices are called units on the menu.

Note *To change a numerical value, you press the CHG button one additional time and then use the arrow buttons.*

The range can be set to Auto or to Fixed low, Fixed mid or Fixed high. The fixed ranges are useful for short measurement cycles during which the voltmeter doesn't have time to change range automatically. If this occurs, O.F. (range overflow) is displayed constantly.

For more information about the different ranges see Chapter 9, Specifications.

Menu option	Alternative	Explanation
AC	Alt. 1.	Voltmeter measures AC as true RMS
DC	Alt. 2.	Voltmeter measures DC as mean value
Shunt	1–999 mΩ	Value is shown as A or kA
Unit: Volt	Alt. 1.	Voltage is shown in volts
Unit: % of nom U	Alt. 2.	Voltage is shown as a % of the nominal voltage which can range from 1 to 999 V.
Nom U: 063 V	—	Used to set the nominal voltage.
Range: Auto	Alt. 1.	Range selected automatically
Range: Low	Alt. 2.	Fixed low range
Range: Mid	Alt. 3.	Fixed mid range
Range: High	Alt. 4.	Fixed high range

1] Press the SEL button to invoke the selected option.

5.9 Ω, φ, W, VA... (Extra measurement)

Ω, φ, W, VA. . .

<None>

Here, you can select extra measurement functions (in addition to the voltage and current functions)

For all extra measurement functions, SVERKER must be set for AC measurement, i.e. for AC Amp and AC Volt. However, this does not apply to the measurement of resistance or active power. For these, DC measurement can also be used.

Either voltage or current can be used as a reference for calculating the phase difference (phase angle) between current and voltage.

Then, when SVERKER is used in the generation mode (normal mode), the selected extra measurement function is displayed at the top of the window, beside the time. Only one option can be selected at a time.

Menu option for A AC / V AC (AC measurement)	Explanation
None	No extra measurement function displayed
Z (Ω, °)	Impedance and phase angle displayed
Z (Ω)	Impedance displayed without phase angle
R, X (Ω, Ω)	Resistance and reactance displayed
P (W)	Active power displayed
P (VA)	Apparent power displayed
Q (VAr)	Reactive power displayed
cos φ	Power factor displayed
φ (°, Iref)	Phase difference displayed with current as reference
φ (°, Uref)	Phase difference displayed with voltage as reference
Frequency (U)	Frequency displayed

Menu options for A DC / V DC (DC measurement)	Explanation
No choice	No extra measurement function displayed
R (Ω)	Resistance displayed
P (W)	Power displayed

Menu options for A DC / V AC or A AC / V DC (mixed measurement)	Explanation
No choice	No extra measurement function displayed

1] Press the SEL button to invoke the selected option.

5.10 Timer

Timer

<Unit: Seconds >

Here you select the unit in which the time displayed in the window by the timer is expressed. Time measurements can be expressed in seconds (s) or in mains-frequency cycles.

Menu option	Alternative	Explanation
Unit: Seconds	Alt 1.	Time expressed in seconds
Unit: Cycles	Alt 2.	Time expressed in mains-frequency cycle

- 1] Press the SEL button to invoke the selected option.

5.11 Display

Display

<Slow>

If the values shown on the display become unstable as measurement proceeds, you can filter them. Filtering is accomplished by averaging, and it affects all displayed values.

Extra measurement functions such as R and X can now be calculated after finishing a test (after a HOLD trip).

Menu option	Explanation
Slow	Average-value filter enabled, thereby stabilizing the display. 10 values are used to create the average. Phase difference is not filtered. Only for measurement purpose, not to be used for time test.
Fast	Average-value filter disabled. Used always as default for time test.
Hold Trip	Shows the max value in RMS for 1 period immediately before tripping.
Hold Max	Shows the max value in RMS for 1 period within the last 0.5 s held in memory.
Hold Min	Shows the min value in RMS for 1 period within the last 0.5 s held in memory.

- 1] Press the SEL button to invoke the selected option.

5.12 Off delay

Off delay
<004 Cycles>

This is used to set the time, expressed in mains-frequency cycles throughout which generation is to continue after tripping occurs. The range is 0-999 cycles. The original Megger setting is 4 cycles. If no delay is desired, set the number of cycles to 0.

Note *To change a numerical value, press the CHG button one additional time, and then use the arrow buttons.*

Range: 000-999.

- 1] Press the SEL button to invoke the selected option.

5.13 0-Level filter

0-Level filter
<1=Min, 9=Max>

To avoid measuring noise that can be encountered during testing, SVERKER features a well-defined lower limit called the 0-level.

When testing ground fault protection (for example) using low currents, this difficulty could arise in cases where test values were below the 0-level.

The 0-level can be set between 1 and 9. A 0-level of 1 (min.) allows low-level signals to pass. A 0-level of 9 (max.) filters out most noise. A 0-level of 5 is the same as the level provided in the previous version.

5.14 Save/Recall

Save/Recall
<Settings>

The settings made under the headings/options discussed above can be saved in a memory where they will remain even after SVERKER has been turned off. Then when you want to conduct a similar test again, they can be recalled from the memory in question. There are four such memories.

Each time SVERKER is turned on, the contents of memory No. 0 are recalled as defaults. You can, however, recall and use the contents of any other memory by specifying its number in this menu.

In addition, there is a special memory that contains the original SVERKER settings, and they can be recalled whenever you want to use them.

Menu option	Explanation
Recall mem #:	Recall settings from the specified SVERKER memory (range is 0-3)
Recall default:	Recall the original Megger settings from the special memory
Save mem #:	Save the settings in the specified SVERKER memory (range is 0-3)

- 1] Press the SEL button to invoke the selected option.

5.15 Remote control

Remote control
<OFF>

Together with the PC software SVERKER Win you can control the settings (except the dials) from the computer.

When SVERKER Win is started, the text "Remote Control" will appear on the display.

5.16 Language

Language
<English>

Here, you select one of five languages in which the menus, prompts etc. will appear.

Menu option	Explanation
English	English-language menus, prompts etc.
Deutsch	German-language menus, prompts etc.
Français	French-language menus, prompts etc.
Español	Spanish-language menus, prompts etc.
Svenska	Swedish-language menus, prompts etc.
čeština	Czech language menus, prompts etc.
Türk	Turkish language menus, prompts etc.

- 1] Press the SEL button to invoke the selected option.

5.17 SW

SW: R04D

This enables you to display the software version and hardware version. The user cannot change this information.

Menu heading	Explanation
SW	Software version you are using.

Note *If you have "unlocked" the SVERKER using the "software key" for SVERKER Win, this is shown with the text "PC-750" or "SVERKER Win" in the "Software version" window in the menu tree.*

6 How to operate SVERKER

6.1 General

This chapter presents the steps you should take to perform typical SVERKER testing operations efficiently. Sometimes several alternative ways of carrying out a step are presented. This chapter will help you formulate testing procedures for different types of protective relay equipment.

6.2 Injecting current – General rules

When you inject current through protective relay equipment for testing purposes, you must observe several rules of thumb:

- Provide as much impedance as possible in series with the load.
This will counteract changes in current and minimize waveform distortion for relays whose impedances change when they have operated, and also for relays that become saturated.
Moreover, the current become more easy to adjust, since this will increase the turn of the knob.
- When you are measuring operating times, the value of the applied current or voltage used for testing must exceed the tripping limit by an ample margin (rule of thumb: 1.2-1.5 times the pick-up limit).
- High current should be injected through the protective relay equipment for as short a time as possible to prevent overheating.
It may be advisable to use manually-controlled (momentary) generation or time-limited generation when injecting high current.

Output alarm

If more than 1 V/ 0.5 A flows (in the 10 A range) when SVERKER is in the OFF state there will be a message on the display "CAUTION OUTPUT".

CAUTION OUTPUT

6.3 Selecting the correct current output

Select the output at which the setting knob must be turned the furthest to obtain the desired current. This will improve setting accuracy and enable SVERKER to deliver maximum power.

When the object being tested has high impedance or may reach saturation, it is especially important to use the output having the highest possible voltage. This will drive the desired current through the object being tested efficiently and minimize distortion of the current waveform.

6.4 Measuring current

The ammeter in SVERKER has four inputs. Three of them are internal inputs fixed to the individual current outputs, and one is an external input located on the control panel. Active input (i.e. ammeter test point) is indicated by an indicator lamp.

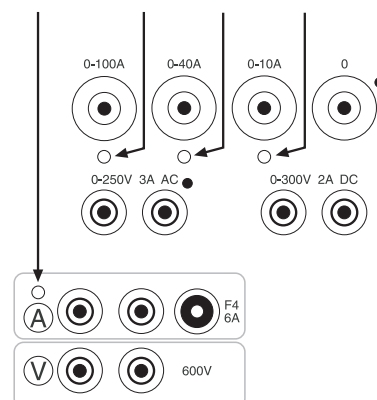

Use the button marked A to transfer the ammeter test point to the selected input.



The internal inputs are used to measure the current generated by SVERKER. The external input is used to measure current in an external circuit. If so desired, however, it can be used for measurement of current from SVERKER. This is useful since ammeter accuracy is highest when measurement proceeds via the external input. The external input can be used for currents of up to 6 A.

The HOLD (freeze) function makes it possible to measure currents of very short duration. Activate it by pressing the button marked HOLD. See the section headed "Ammeter and voltmeter" in Chapter 3.



6.5 Setting the desired current

- 1] Connect the object being tested to a suitable output on SVERKER.
- 2] Use the button marked A to transfer the ammeter test point to the selected current output or to the external ammeter panel input.
- 3] Activate ON using the start switch.



- 4] Adjust the current using the main knob. The current can be read from the SVERKER display.

High currents

High currents may overheat both the object being tested and SVERKER. You can prevent overheating by generating currents of very short duration. Short-duration currents can be read very easily using the ammeter's HOLD (freeze) function.

The best way to generate short-duration currents is to use manually-controlled (momentary) or time-limited generation. See explanation of settings in Chapter 5.

- 1] Connect the object being tested to a suitable output.
- 2] Use the button marked A to transfer the ammeter test point to the selected output.
- 3] Activate the HOLD (freeze) function.
- 4] Activate ON briefly using the start switch.
- 5] Read the current.
- 6] Repeat, starting with step 4, until the correct current is set.

Low currents and good setting resolution

You can obtain low currents and good setting resolution by connecting one or more of the resistors in the SVERKER set of resistors in series in the current circuit. You can also use these resistors to create a voltage divider, thereby reducing the output current.

Limiting resistors can also be connected into the primary side (terminal Rx/Cx) of the output transformer. More-over, if you want to limit the current without generating heat, you can connect the SVERKER capacitor (only SVERKER 750), although this will change the phase angle of the current.

Sometimes it is advantageous to use the 0-100 A output when you want low currents since it has the

lowest output voltage. This low voltage will drive a lower current than any of the other SVERKER outputs through a high-ohm load or series resistor.



Always use the ammeter input for external measurement when measuring low currents since it provides the best accuracy.

6.6 Finding pick-up and drop-out limits for over current/voltage/other entity relays

Method 1a: Normal injection, gradual increase in current.

Current is generated continuously. This procedure is suitable in situations where there is little risk of overheating the protective relay equipment and you wish to measure the drop-out function without using a second test procedure.

- 1] Initial settings: OFF. Main knob at 0.
- 2] Connect the relay's current input and tripping output to SVERKER.
- 3] Use the button marked A to transfer the ammeter test point to the selected output.
- 4] Set the timer stop condition (to CLOSURE + OPENING, CONTACT for example).
- 5] Activate ON using the start switch.
- 6] Turn up the current until the relay operates (pick-up).
- 7] Read the current.
- 8] Turn down the current. Read the current that flows when drop-out takes place.
- 9] Interrupt output by setting the start switch to OFF.

Method 1b: Normal injection, pick-up and drop-out values obtained using the HOLD (freeze) function

Increase the current gradually until the relay operates, whereupon the current reading is frozen. You can then start reducing the current immediately, and the current reading will be frozen when drop-out occurs.

- 1] Initial settings: OFF. HOLD. Main knob at 0.
- 2] Connect the relay's current input and tripping output to SVERKER.
- 3] Use the button marked A to transfer the ammeter test point to the current output that is being used.
- 4] Set the timer stop condition (to CLOSURE + OPENING, CONTACT for example).
- 5] Activate ON using the start switch.
- 6] Turn up the current until pick-up.
- 7] The tripping limit will be frozen and held on the display.
- 8] Press the HOLD button twice in order to reset

the HOLD function.

- 9] Turn down the current until the relay drops out. You can now read the frozen drop-out value from the display window.
- 10] Interrupt output by setting the start switch to OFF.

Method 2: Manually-controlled (momentary) injection

Here, the current is interrupted when you release the start switch (from the ON or ON+TIME position). This procedure enables you to prevent overheating of the protective relay equipment when, for example, you are trying to find the pick-up value for an instantaneous unit.

- 1] Initial settings: OFF. MOMENTARY (see explanation of settings in Chapter 5). HOLD. Main knob at 0.
- 2] Connect the relay current input and tripping output to SVERKER.
- 3] Use the button marked A to transfer the ammeter test point to the current output that is being used.
- 4] Set the timer start condition to INT.
- 5] Set the timer stop condition (to CLOSURE + OPENING, CONTACT for example).
- 6] Change the main knob setting.
- 7] Activate ON briefly. The duration of the output must be longer than the operating time of the instantaneous unit. If you want to check the time, you can activate ON+TIME instead of ON.
- 8] Check to see that the instantaneous unit has tripped. This can be done by a) checking the indicator lamp on the relay or b) checking to see that the TRIP indicator lamp in SVERKER is on and that the measured operating time matches the operating time of the protective relay equipment. Repeat, starting with step 6, until you find the lowest current that provides operation.
- 9] Read the current.
- 10] To measure the drop-out value, activate ON again using the start switch until tripping occurs. Then, while keeping ON active, reduce the current by turning the main knob until resetting takes place. Release the start switch and make a note of the current.

Method 3: Time-limited injection

Time-limited injection Time-limited generation, as its name implies, interrupts output after a preset time. This is useful when you want to prevent overheating in the protective relay equipment.

- 1] Initial settings: OFF. MAX TIME (see explanation of settings in Chapter 5.) HOLD. Main knob at 0. The maximum time must be set longer than the operating time of the instantaneous unit.
- 2] Connect the relay current input and tripping output to SVERKER.
- 3] Set the ammeter to measure current at the current output that is being used.
- 4] Set the timer start condition to INT.
- 5] Set the timer stop condition (to CLOSURE + OPENING, CONTACT for example).
- 6] Change the main knob setting.
- 7] Activate ON using the start switch. If you want to check the time, you can activate ON+TIME instead of ON.
- 8] Check to see that the instantaneous unit has operated. This can be done by a) checking the indicator lamp on the relay or b) checking to see that the TRIP indicator lamp on SVERKER is on.
- 9] Read the current.
- 10] Search for the lowest current where the relay operates, by repeating from point 6 above and onwards.

6.7 Finding pick-up and drop-out limits for under current/voltage/other entity relays

- 1] Initial settings: OFF, HOLD, Main knob at 0.
- 2] Connect the relay input and tripping output to SVERKER.
- 3] Use the button marked A to transfer the ammeter test point to the current output that is being used.
- 4] Set the timer stop condition (to CLOSURE + OPENING, CONTACT for example).
- 5] Activate ON using the start switch.
- 6] Increase the entity (current or voltage) being tested until it exceeds by an ample margin the value of the relay setting.
- 7] Turn the main knob anti-clockwise until the relay trips. Read the pick-up value.
- 8] Turn the main knob clockwise until the relay drops out. Read the drop-out value.
- 9] Interrupt output by setting the start switch to OFF.

6.8 Measuring operating times for over current/voltage/other entity relays

Method 1: Normal injection

Generation continues until the protective relay equipment operates.

- 1] Initial setting: OFF, HOLD, Main knob at 0.
- 2] Connect the relay current input and tripping output to SVERKER.
- 3] Use the button marked A to transfer the ammeter test point to the selected output.
- 4] Set the timer start condition to INT.
- 5] Set the timer stop condition (to CLOSURE + OPENING, CONTACT for example).
- 6] Activate ON using the start switch. Set the desired current for measuring the operating time. This current must be set well above the operating limit.
- 7] Interrupt output by setting the start switch to OFF.
- 8] Activate ON+TIME using the start switch.
- 9] Read and note the time and current.

Method 2: Manually-controlled (momentary) injection

This is useful when you want to eliminate overheating in the relay. Generation continues only as long as the start switch is kept at the ON position.

- 1] Initial settings: OFF. MOMENTARY (see explanation of settings in Chapter 5). HOLD. Main knob at 0.
- 2] Connect the relay's current input and tripping output to SVERKER.
- 3] Use the button marked A to transfer the ammeter test point to the output that is being used.
- 4] Set the timer start condition to INT.
- 5] Set the timer stop condition (to CLOSURE + OPENING, CONTACT for example).
- 6] Set the desired current (it must exceed the pick-up value by an ample margin) by changing the setting of the main knob. Activate ON briefly using the start switch and read the current from the ammeter. Repeat until the desired current has been set.
- 7] Activate ON+TIME using the start switch and keep it activated until tripping occurs.

- 8] Read and note the time and current.

Method 3: Time-limited injection

Time-limited generation, as its name implies, interrupts output after a preset time. This is useful when you want to prevent overheating in the protective relay equipment.

- 1] Initial settings: OFF. MAX TIME (see explanation of settings in Chapter 5.) HOLD. Main knob at 0. The maximum time must be set longer than the operating time of the instantaneous unit.
- 2] Connect the relay current input and tripping output to SVERKER.
- 3] Set the ammeter to measure current at the current output that is being used.
- 4] Set the timer start condition to INT.
- 5] Set the timer stop condition (to CLOSURE + OPENING, CONTACT for example).
- 6] Change the main knob setting.
- 7] Activate ON+TIME using the start switch.
- 8] Check to see that the instantaneous unit has operated. This can be done by a) checking the indicator lamp on the relay or b) checking to see that the TRIP indicator lamp on SVERKER is on.
- 9] Read and note the time and current.
- 10] Search for the lowest current where the relay operates, by repeating from point 6 above and onwards.

6.9 Measuring operating times for under (current/voltage/ other entity) relays

- 1] Initial setting: OFF.
- 2] Connect the relay current input and tripping output to SVERKER.
- 3] Set the timer start condition to INT.
- 4] Set the timer stop condition (to CLOSURE + OPENING, CONTACT for example).
- 5] Activate ON using the start switch. Set the entity (current or voltage) being tested so that it exceeds by an ample margin the value that has been preset for the relay.
- 6] Activate OFF+TIME using the start switch
- 7] Read and note the time and current.

6.10 Measuring voltage



- 1] Set the voltmeter to measure AC or DC (see Chapter 6).
- 2] Connect the voltmeter input to the voltage that is to be measured. Do not exceed the voltmeter specifications.

Note *To measure a voltage in the HOLD state, you must simultaneously measure a current (by short-circuiting the current output with a wire for example).*

6.11 Obtaining the correct phase angle when two or more AC outputs are being used

Three separate AC voltages can be obtained from SVERKER:

- 0-250 V AC output from the current source.
- 0-120 V AC voltage source (SVERKER 750)
5-220 V AC voltage source (SVERKER 780)
- 0-100 A, 0-40 A and 0-10 A current outputs (from different taps on the same winding).

If these are connected to a common point, it's important to know the polarity. The right-hand terminal in each of the outputs is thus provided with a black dot, thereby indicating that these output socket terminals have the same polarity.

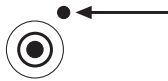

6.12 Generating higher voltages

Since the AC voltages sent out from SVERKER are separated from each other and from the mains, series connections can be made.



Important

Be sure to comply with the applicable safety regulations and never exceed any insulation voltage limits.

6.13 Setting an auxiliary voltage

- 1] Connect the SVERKER voltmeter input to the output of the auxiliary voltage source.
- 2] Set the voltmeter to measure DC (see explanation of settings in Chapter 5).
- 3] Select the range to be used for the auxiliary voltage (20-130 V or 130-220 V).
- 4] Turn on the auxiliary voltage source and set the desired value.
- 5] Turn off the auxiliary voltage source.
- 6] Connect the auxiliary voltage to the relay.
- 7] Turn on the auxiliary voltage source. Check the voltage on the SVERKER voltmeter.

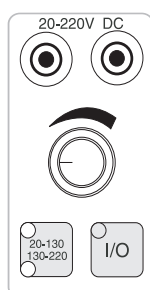

6.14 Testing voltage relays – both pre-fault and fault voltages

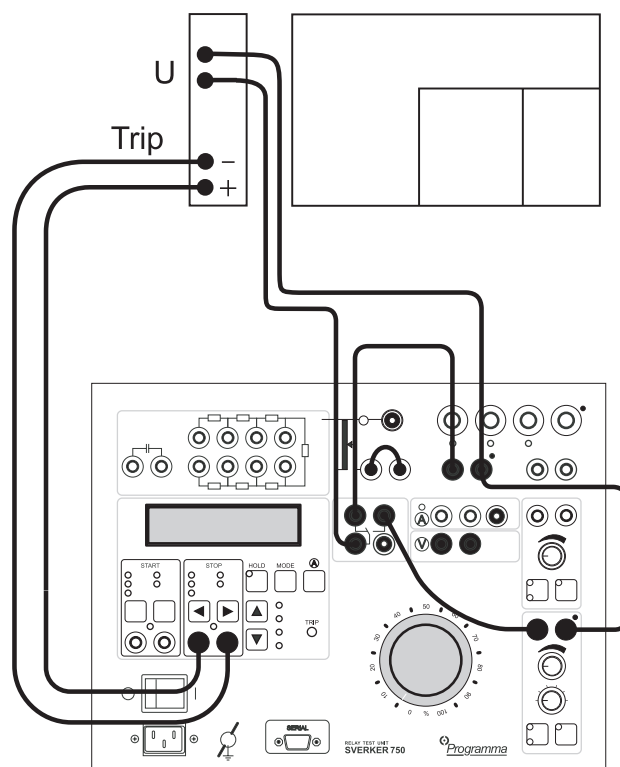

Sometimes it is necessary to change between two voltage levels and measure the time that elapses until operation. This can be done using the SVERKER make/break contact.

- 1] Connect the voltmeter input to the 0-250 V output. Activate ON using the start switch. Set the voltage that corresponds to the pre-fault voltage.
- 2] Set the start switch to OFF.
- 3] Connect the voltmeter input to the 0-120 V AC voltage source. Turn on the AC voltage source and set the voltage that corresponds to the fault voltage.
- 4] Turn off the AC voltage source.
- 5] Connect together the terminals marked with black dots on the 0-250 V output and on the AC voltage source. From this junction, make a connection to one side of the relay's voltage input.
- 6] Connect the left-hand socket terminal on the 250 V output to the upper left-hand socket terminal on the make/break contact (the one that performs a break function).
- 7] Connect the left-hand output socket terminal on the AC voltage source to the upper

right-hand socket terminal on the make/break contact (the one that performs a make function).

- 8] Connect the lower left-hand socket terminal on the make/break contact to the other side of the relay voltage input.
- 9] Make certain that the relay tripping output is properly connected to SVERKER.
- 10] Activate ON using the start switch, whereupon the pre-fault voltage will be applied to the relay.
- 11] Turn on the AC voltage source.
- 12] Activate OFF+TIME using the start switch, whereupon fault voltage will be applied to the relay and timing will start.
- 13] Read the time at which the relay operated.

6.15 Changing the current and voltage phase difference

SVERKER 750

Using the built-in capacitor and set of resistors, you can change the phase difference between current and voltage. You can connect the phase-changing components at either the current output or voltage output.



Tip

It is easiest to change the phase angle of the entity (current or voltage) having the lowest power.

The capacitor can be connected in series with the current output if the current is not excessively high. This provides almost a 90° phase displacement of the current. The phase angle is determined by the phase-changing components and the load. Since changing the phase angle also causes the current/voltage to change, you must first adjust the phase angle and then set the current/voltage.

If possible, use the ammeter's external panel input to measure the phase angle since this will provide better accuracy and lower currents.

SVERKER 780

- 1] Connect the AC voltage output (22) to the voltmeter.

Note *Connect the output marked with the "black dot" to the black input on the voltmeter.*

- 2] Select ϕ (°, Iref) or ϕ (°, Uref), see section 5.9 Extra measurement.
- 3] Press the button (44) to enable the output
- 4] Set the amplitude of the AC voltage with the knob (23).
- 5] Generate a low current to make it possible to measure the phase angle.
- 6] Set the phase-angle by using the knob (43).

6.16 Measuring the phase angle

The phase angle between the current being measured by the SVERKER ammeter and the voltage across the SVERKER voltmeter input can be displayed (see Explanation of settings in Chapter 5).

Phase angle Current and voltage can be measured regardless of whether or not they are generated by SVERKER. If the current is less than 6 A, it should be measured at the ammeter's external input, since it provides better accuracy.

The phase of the current or the voltage can be selected as reference, see chapter 5 Settings.

Example

Phase shift at an inductive load (current lags voltage). Current selected as reference.

A] Current generated by SVERKER (ammeter connected internally)

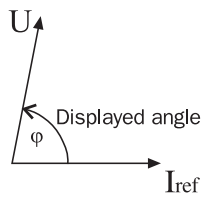
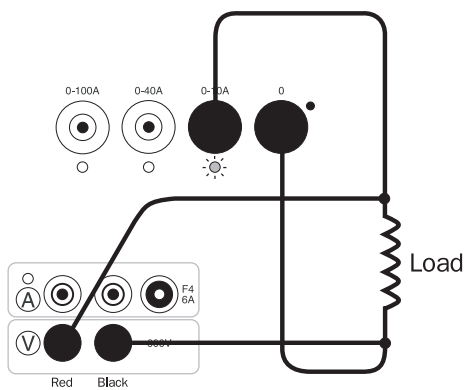

B] Current generated by external source (ammeter panel input used)

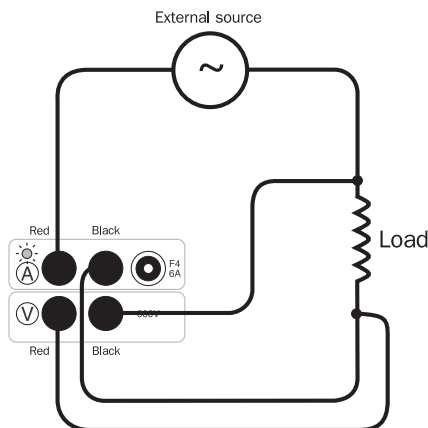

Definition of polarities

A] Current generated by SVERKER (ammeter connected internally).

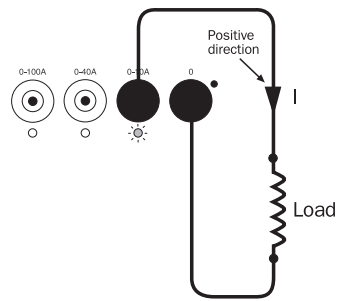

B] Current generated by external source (ammeter panel input used).

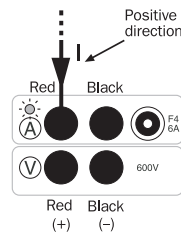

6.17 Measuring external cycle time (measurement not initiated by SVERKER)

The timer's start and stop inputs are independent of each other. Activation takes place when the preset condition is met (pulse-edge triggering). These inputs are not polarity-dependent when voltage is being measured.

- 1] Initial settings: OFF. Main knob at 0.
- 2] Connect the SVERKER start input (START) to the circuit that is to start measurement.
- 3] Connect the SVERKER stop input (STOP) to the circuit that is to stop measurement.
- 4] Set the start condition (to CLOSURE, VOLTAGE for example).
- 5] Set the stop condition (to CLOSURE, CONTACT for example).
- 6] The input state indicator lamp at each input shows whether or not the desired condition is present there before the cycle starts.
- 7] Activate ON+TIME using the start switch.
- 8] The timer is now ready to start.

6.18 Measuring Z, P, R, X, VA, VAR and COS φ

SVERKER can be used to measure these entities, even in external circuits. Here the currents phase is used as reference. For information about phase definitions, see section 6.15, entitled "Measuring the phase angle".

- 1] Connect the SVERKER ammeter and voltmeter to the current and voltage circuit respectively.
- 2] Check the AC/DC setting. See explanation of settings in Chapter 5.
- 3] Set the entity that is to be measured (see explanation of settings in Chapter 5).

Note *The HOLD (freeze) function can also be used for these measurements.*

6.19 Plotting a magnetization curve

Since SVERKER has an ammeter, voltmeter and voltage output, it can be used to plot points on a current transformer magnetization curve.

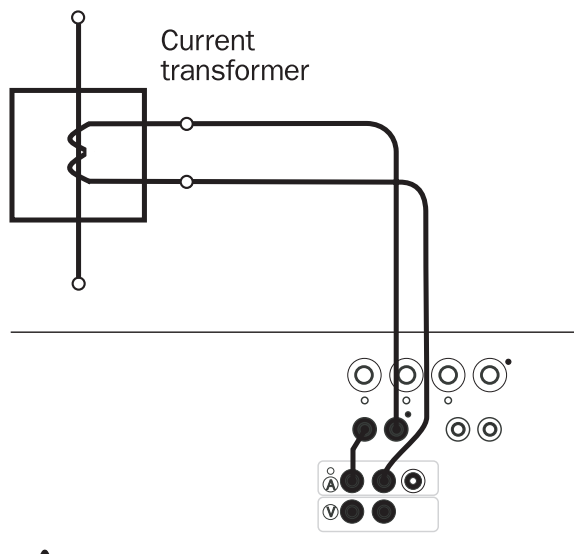

Important

Be sure to comply with the applicable safety regulations, and never exceed any insulation voltage limits.

- 1] Initial setting: OFF. Main knob at 0.
- 2] The primary side of the current transformer must be open, and the secondary side must not be connected to any other circuit.
- 3] Connect the SVERKER voltage output to the secondary side of the current transformer. One side of this voltage output must be connected via the SVERKER ammeter input. If a voltage higher than 250 V is needed, proceed as instructed in section 6.11, entitled "Generating higher voltages".
- 4] Connect the SVERKER voltmeter input to the SVERKER voltage output.
- 5] Use the button marked A to transfer the ammeter test point to the panel input used for measurement in external circuits.
- 6] Activate ON using the start switch.
- 7] Turn the knob clockwise and read the current and voltage for different points on the curve.
- 8] When the knee of the curve is reached, slowly lower the voltage and set the start switch to OFF.

6.20 Testing an automatic recloser

SVERKER can be used to measure partial times in a reclosing cycle. The relay times and the de-energized intervals are stored so that you after the measurement can scroll through them on the display whenever desired. The SVERKER make/break contact can be used to stimulate the state of the breaker for the automatic recloser.

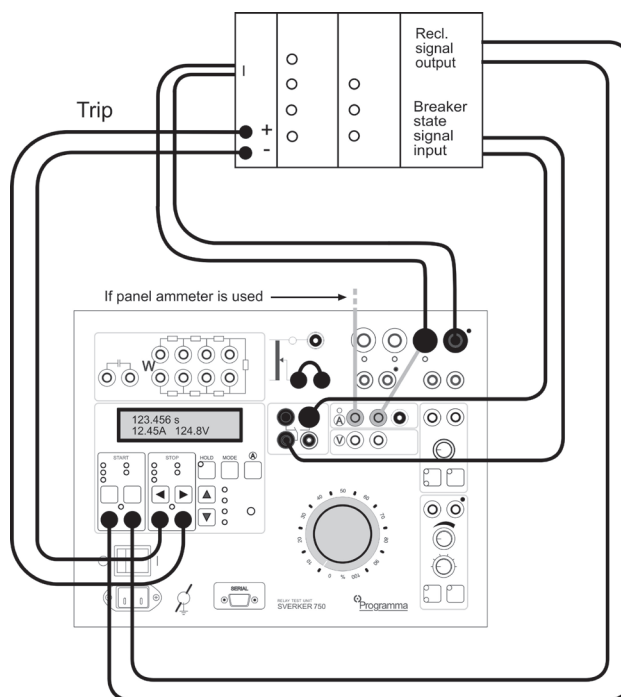

- 1] Initial setting: OFF. Main knob at 0. Set SVERKER to measure reclosing (see explanation of settings in Chapter 5). You can also set a time limit so that the test will be interrupted when the time limit expires.
- 2] Connect the reclosing signal to the SVERKER timer start input (START). The relay tripping signal must be connected to the timer stop input (STOP). Connect the relay current input to a suitable current output on SVERKER. If the automatic recloser requires a breaker-state indication signal, you can create such a signal by connecting the SVERKER make/break contact (perhaps in series with the voltage source) to the automatic recloser.

Note *The Make/Break contact will shift position when SVERKER is set to "Reclose mode" (see also page 24).*

- 3] Use the button marked A to transfer the ammeter test point to the output that is being used.
- 4] Set start and stop conditions

- 5] Activate ON using the start switch.
- 6] Turn up the desired test current.
- 7] Set the start switch OFF.
- 8] Start the reclosing cycle by activating ON+TIME using the start switch.
- 9] Check that the switch is in position OFF after the cycle has been completed.
- 10] You can now scroll through the relay times and the de-energized intervals on the display using the ▲ and ▼ buttons. Please note: Current value is not shown.

T#02:	489ms	I
T#03:	75ms	0

- 11] After you press the button marked MODE, you can start a new test.

6.21 Measuring the trip pulse length

- 1] Initial settings: OFF. TRIP+PULSE TIME, HOLD. Main knob at 0.
- 2] Connect the relay current input and tripping output to SVERKER.
- 3] Use the button marked A to transfer the ammeter test point to the input used for measurement in external circuits.
- 4] Set the start condition to INT.
- 5] Set the stop condition (to CLOSING + OPENING, CONTACT for example).
- 6] Activate ON using the start switch. Set the entity (current or voltage) being tested so that it exceeds by an ample margin the value that has been preset for the relay.
- 7] Set the start switch OFF.
- 8] Start the test cycle by activating ON+TIME using the start switch.

After the test cycle the display window shows the result.

T#00:	689ms	I
T#01:	53ms	0

T#00 = Time from START to STOP.

T#01 = Time of trip pulse.

Total = The total time, T#00 + T#01.

- 9] Press the ▼ button once to get here. Read and note the times at which the relay operated. Please note: Current value is not shown.
- 10] After you press the button marked MODE, you can start a new test.

6.22 Injecting current – External start

You can start generation by sending an external signal to SVERKER. This feature enables you to start two or more SVERKERs simultaneously. The “slave” SVERKERs can be connected to the make/break contact on the “master” and then set for external start, whereupon they will start simultaneously with the master (± 1 ms).

- 1] Connect the external signal to the START input (12).
- 2] Select dry or wet contact and closing or opening contact, for the external signal.



Tip

If 120° phase shift is desired between the SVERKERs, you can connect them to the different phases of a 3-phase outlet.

7 Application examples

7.1 Testing voltage relays

The following functions are to be tested:

- Pick-up function: $U > ON$
- Drop-out function: $U > OFF$
- Operating time: $U > ON + TIME DELAY$

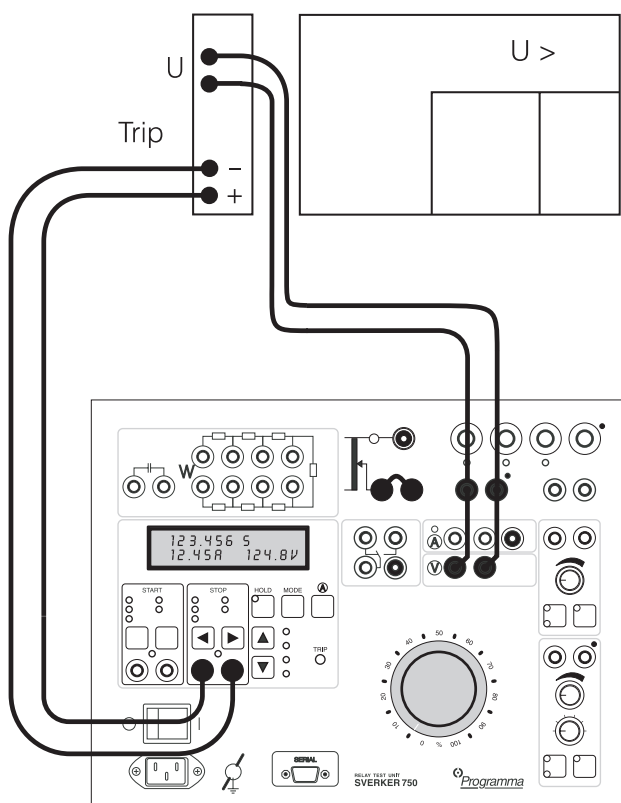

Test hook-up and initial settings

Connect for testing as shown in the above diagram.

- 1] Connect the SVERKER AC voltage to the protective relay equipment.
- 2] Also connect the SVERKER AC voltage to the voltmeter input.
- 3] Connect the timer stop input (STOP) to the relay trip output.
- 4] Turn on power to SVERKER using the mains switch.
- 5] Activate the desired stop condition for the timer by setting the stop input for a make and/or break function and for a live or dead contact.

- 6] If the display window is to freeze the voltage reading at the instant of operation, check to see that the HOLD function is active (it can be activated by means of the HOLD button).

Pick-up and drop-out functions: $U > ON$ and $U > OFF$

- 1] Turn on the SVERKER voltage source by activating ON with the start switch (press the ▼ key once), whereupon the ON indicator lamp will light.
- 2] Increase the voltage carefully until the protective relay equipment operates ($U > ON$), whereupon the SVERKER TRIP indicator will start to glow steadily.
- 3] Read the $U > ON$ value from the SVERKER display window.
- 4] If the freeze function has been activated, press the HOLD button twice to unfreeze the value shown.
- 5] Decrease the voltage until the relay is reset ($U > OFF$ (drop-out)), whereupon the TRIP indicator will be extinguished.
- 6] Read the $U > OFF$ (drop-out) value from the SVERKER display window.
- 7] Decrease the voltage to 0.
- 8] Turn off the SVERKER current source by setting the start switch to the OFF position.

Operating function: $U > ON + TIME DELAY$

- 1] Turn on the SVERKER voltage source by activating ON with the start switch whereupon the ON indicator lamp will light.
- 2] Increase the voltage to $1.5 \times U > ON$.
- 3] Turn off the SVERKER voltage source by setting the start switch to the OFF position.
- 4] Activate ON + TIME by means of the start switch, whereupon the timer will start and the voltage source will start to generate voltage.
- 5] When the protective relay equipment operates, the timer will stop automatically and

- 6] Activate the desired stop condition for the timer by setting the stop input for a make and/or break function and for a wet or dry contact.
- 7] If the display window is to freeze the current reading at the instant of operation, check to see that the HOLD function is active (it can be activated by means of the HOLD button).

Pick-up and drop-out functions: I > ON and I > OFF

- 1] Turn on the SVERKER current source by activating ON with the start switch (press the ▼ key once), whereupon the ON indicator lamp will light.
- 2] Increase the current carefully by turning the main knob until the protective relay equipment operates (I > ON), whereupon the SVERKER TRIP indicator will start to glow steadily.
- 3] Read the I > ON value from the SVERKER display window.
- 4] If the freeze function has been activated, press the HOLD button twice to unfreeze the value shown.
- 5] Decrease the current until drop-out occurs (I > OFF), whereupon the TRIP indicator will be extinguished.
- 6] Read the I > OFF value from the SVERKER display window.
- 7] Decrease the voltage to 0.
- 8] Turn off the SVERKER current source by setting the start switch to the OFF position.

Operating function: I > ON + TIME DELAY

- 1] Turn on the SVERKER current source by setting the start switch to the ON position, whereupon the ON indicator lamp will light.
- 2] Increase the current to 1.5 x I > ON. (For an inverse time relay, you should conduct three tests at 1.5, 2 and 3 x I > ON, thus providing additional test points on the inverse time curve.)
- 3] Turn off the SVERKER current source by setting the start switch to the OFF position.
- 4] Activate ON + TIME by means of the start switch, whereupon the timer will start and the current source will start to generate current.
- 5] When the protective relay equipment operates, the timer will stop automatically and

the current source will be turned off automatically, whereupon the TRIP indicator will start to flash.

- 6] Read the I > ON + TIME DELAY value from the SVERKER display window.
- 7] For the remaining phases, repeat the steps 1-6 as set forth above.

Pick-up and drop-out functions for the high-current stage: I >> ON and I >> OFF

- 1] Move the connections to the desired current output.
- 2] Select the desired test point for the ammeter. This can be done step by step with the A button located to the right of the display window.
- 3] If the protective relay equipment has a separate trip output for I >>, connect it to the timer stop input (STOP) after having disconnected the trip output of I >.
- 4] Turn on the SVERKER current source using the start switch, whereupon the ON indicator lamp will light.
- 5] Increase the current rapidly until the equipment operates (I >> ON), whereupon the SVERKER TRIP indicator will start to glow steadily.
- 6] Read the I >> ON value from the display window.
- 7] If the freeze function has been activated, press the HOLD button twice to unfreeze the value shown.
- 8] Decrease the current until drop-out occurs (I >> OFF), whereupon the TRIP indicator will be extinguished.
- 9] Read the I >> OFF value from the display window.

Operating time: I >> ON + TIME DELAY

- 1] Turn on the SVERKER current source by setting the start switch to the ON position, whereupon the ON indicator lamp will light.
- 2] Increase the current to 1.1-1.2 x I >> ON.
- 3] Turn off the SVERKER current source by setting the start switch to the OFF position.
- 4] Activate ON + TIME using the start switch, whereupon the timer will start and the current source will start to generate current.
- 5] When the protective relay equipment operates, the timer will stop automatically and

the current source will be turned off automatically, whereupon the TRIP indicator will start to flash.

- 6] Read the I >> ON + TIME DELAY value from the SVERKER display window.
- 7] For the remaining phases, repeat the steps 1-6 as set forth above.

Finishing the test

- 1] Enter the values read from the display into the test report.
- 2] Turn off power to SVERKER using the mains switch.
- 3] Disconnect the equipment.

7.3 Testing directional over-current relay systems or directional ground-fault (earth-fault) relay systems

SVERKER 780

The following functions are to be tested:

- Pick-up functions: I > ON and U > ON
- Drop-out functions: I > OF and U > OFF
- Operating time: I > ON + TIME DELAY

Test hook-up and initial settings

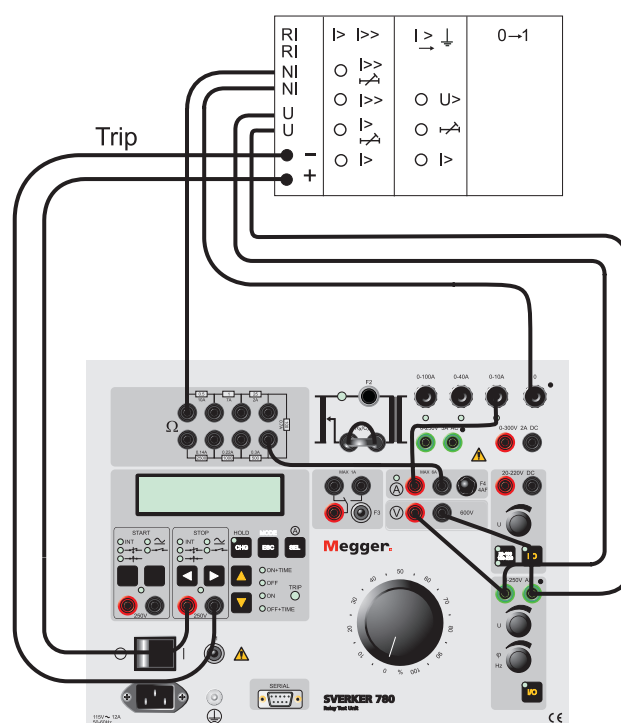

Connect for testing as shown in the above diagram.

- 1] Connect the SVERKER separate 5-220 V AC voltage output to the protective relay equipment input (U).
- 2] Also connect the SVERKER separate AC voltage output to the voltmeter input.
- 3] Connect the SVERKER current source, via the ammeter input and the set of resistors (the resistor you select will depend on the testing current) to the current input (NI) to the protective relay equipment.
- 4] Connect the timer stop input (STOP) to the relay trip output.
- 5] Turn on power to SVERKER using the mains switch.
- 6] Activate the desired stop condition for the

timer by setting the stop input for a make and/or break function and for a wet or dry contact.

Testing the pick-up and drop-out

- 1] Select stop conditions, dry or wet contact.
- 2] Select HOLD to freeze the current reading.
- 3] Press button SEL/ $\text{\textcircled{A}}$ until you get a red light at the built-in ammeter.

Note *Maximum allowed current through the separate ammeter used in this connection example is 6 A. The other measurement points do not have this limitation.*

- 4] Press the MODE button.
- 5] Use the key \blacktriangledown to select Ω , φ , W, VA....
- 6] Press CHG (Change)
- 7] Select φ ($^\circ$, Iref) or ($^\circ$, Uref) by using the key \blacktriangledown .
- 8] Press SEL (Select).
- 9] Press ESC.
- 10] Press button (44) to turn on voltage.
- 11] Set the voltage amplitude with the upper small knob.
- 12] Make sure the main knob is set to "0".
- 13] Turn on the SVERKER output by activating ON using the start switch \blacktriangledown .
- 14] Set the phase-angle. Swop between 10° and 1° steps by pressing the knob (43).

000ms	070 $^\circ$
0.100A	63.05V

Note *A small current flowing in the circuit is required to measure the phase angle.*

- 15] Increase the current until the relay operates (pick-up). Read the value. Press the HOLD button twice to reset the display.
- 16] Decrease the current until the relay drops out. Read the value.

Testing the operation time

- 1] Increase the current to 1.5 times the pick-up value.
- 2] Invoke the ON+TIME state by means of the start switch. The outputs will now remain turned on until the protective relay equipment operates.
- 3] Read the time from the display. Check also

the high current setting using the same procedure.

SVERKER 750

The following functions are to be tested:

- Pick-up functions: I > ON and U ON
- Drop-out functions: I > OFF and U > OFF
- Operating time: I > ON + TIME DELAY

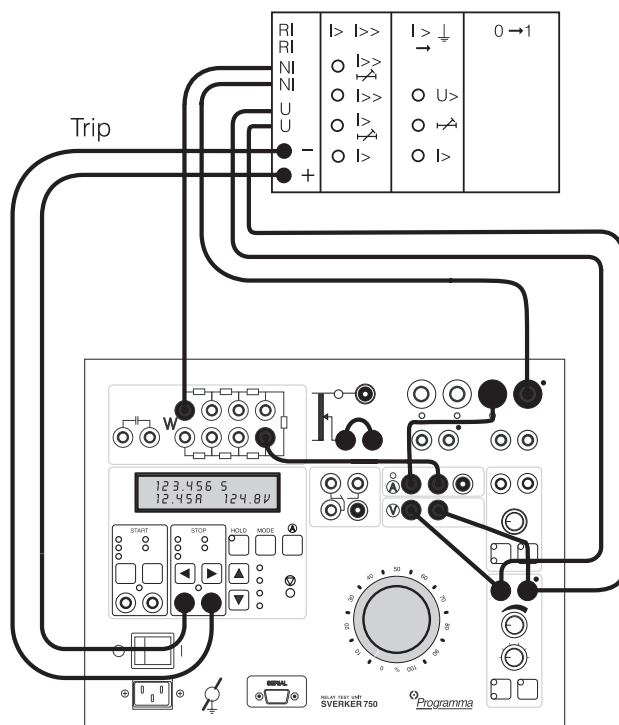

Test hook-up and initial settings

Connect for testing as shown in the above diagram.

- 1] Connect the SVERKER separate 0-120 V AC voltage output to the protective relay equipment input (U).
- 2] Also connect the SVERKER separate AC voltage output to the voltmeter input.
- 3] Connect the SVERKER current source, via the ammeter input and the set of resistors (the resistor you select will depend on the testing current) to the current input (NI) to the protective relay equipment.
- 4] Connect the timer stop input (STOP) to the relay trip output.
- 5] Turn on power to SVERKER using the mains switch.
- 6] Activate the desired stop condition for the timer by setting the stop input for a make and/or break function and for a wet or dry contact.
- 7] Transfer the ammeter test point to the panel

input, whereupon its indicator lamp will light. This can be done step by step with the A button located to the right of the display window.

- 8] Select the desired voltage range (0-60 or 0-120 V) for the separate AC output by pressing the button at left beneath the output.
- 9] Activate the separate AC voltage output by pressing the button at right beneath the output.

Pick-up and drop-out functions: I > ON and I > OFF

- 1] Increase the voltage using the small knob until U > is exceeded. If the protective relay equipment has no adjustable voltage function (U >), set the voltage to the value same as a fault voltage. Keep this voltage constant during the remainder of the test. It is not necessary to test the U-ON and U-OFF voltage limits. It may, however, be desirable to test I > ON and I > OFF at different voltage levels.
- 2] Turn on the SVERKER current source by activating ON with the start switch (press the ▼ key once), whereupon the ON indicator lamp will light.
- 3] Increase the current until the protective relay equipment operates (I > ON), whereupon the SVERKER TRIP indicator will start to glow steadily.
- 4] Read the I > ON value from the display window. If the protective relay equipment fails to operate, reverse the polarity of the voltage circuit.
- 5] If the freeze function has been activated, press the HOLD button twice to unfreeze the value shown.
- 6] Decrease the current until drop-out occurs (I > OFF), whereupon the TRIP indicator will be extinguished.
- 7] Read the I > OFF value from the display window.
- 8] Decrease the current to 0. 9. Turn off the SVERKER current source by setting the start switch to the OFF position.

Operating time: I > ON + TIME DELAY

- 1] Turn on the SVERKER current source by setting the start switch to the ON position, whereupon the ON indicator lamp will light.
- 2] Increase the current to 1.5 x I > ON. (For an inverse time relay, you should conduct three

tests at 1.5, 2 and 3 x I > ON, thus providing additional test points on the inverse time curve.)

- 3] Turn off the SVERKER current source by setting the start switch to the OFF position.
- 4] Activate ON + TIME by means of the start switch, whereupon the timer will start and the current source will start to generate current.
- 5] When the protective relay equipment operates, the timer will stop automatically and the current source will be turned off automatically, whereupon the TRIP indicator will start to flash.
- 6] Read the ON + TIME DELAY value from the SVERKER display.

Pick-up and drop-out functions: U > ON and U > OFF

- 1] Decrease the voltage using the small knob until the voltage drops beneath U.
- 2] Turn on the SVERKER current source using the start switch, whereupon the ON indicator lamp will light.
- 3] Increase the current with the main knob until I > ON is exceeded (more than 1.1-1.2 x I > ON).
- 4] Increase the voltage using the small knob until the protective relay equipment operates (U > ON), whereupon the SVERKER TRIP indicator will start to glow steadily.
- 5] Read the U > ON value from the display window.
- 6] If the freeze function has been activated, press the HOLD button twice to unfreeze the value shown.
- 7] Decrease the voltage until drop-out takes place (U > OFF), whereupon the TRIP indicator will be extinguished.
- 8] Read the U > OFF value from the display window.

Finishing the test

- 1] Enter the values read from the display into the test report.
- 2] Turn off power to SVERKER using the mains switch.
- 3] Disconnect the equipment.

7.4 Testing power relays

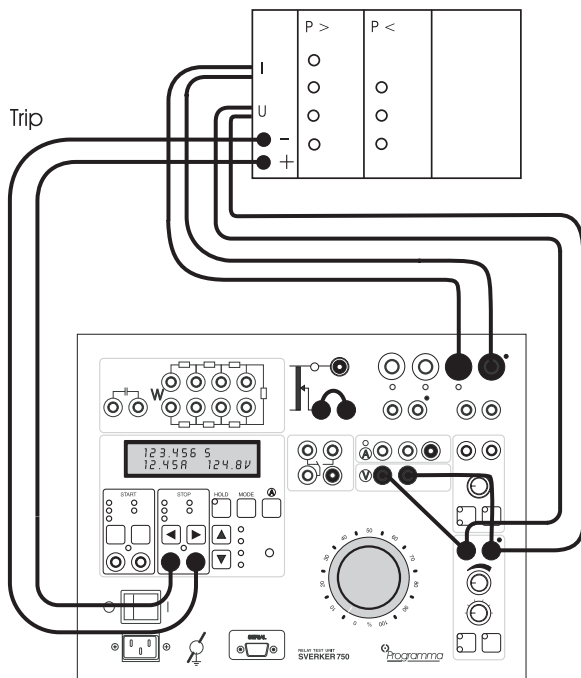

P: Active power $\alpha = 0^\circ$

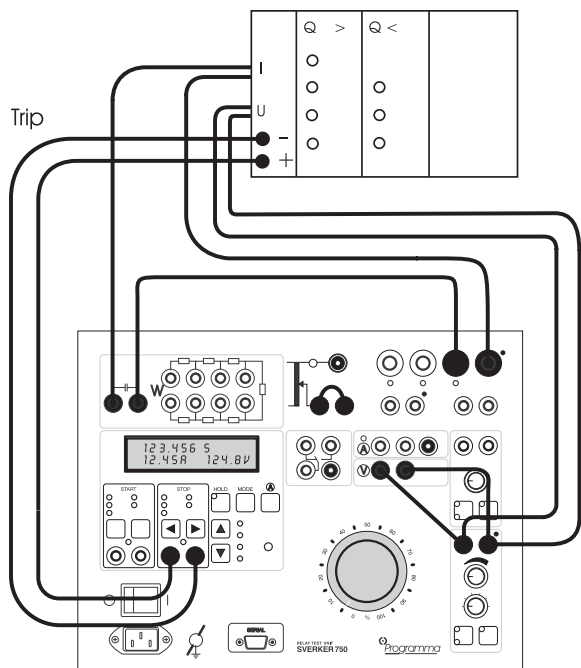

Q: Reactive power $\alpha = 90^\circ$ (phase-shifting capacitor in current circuit)

The following functions are to be tested:

- Pick-up function: P > ON or Q > ON
- Drop-out function : P > OFF or Q > OFF
- Operating time: P > ON + TIME DELAY or Q > ON + TIME DELAY
- Sensitivity (depends on phase angle)

Make a note of the relay setting data (U, I and time delay as well as P or Q). If so desired, calculate the

operating/drop-out values that are of interest:

$$P = U * I * \cos \varphi \text{ or } Q = U * I * \sin \varphi$$

Test hook-up and initial settings

Connect for testing as shown in the above diagram.

- 1] Connect the SVERKER separate 0-120 V AC voltage source to the protective relay equipment voltage input.
- 2] Connect the SVERKER current source to the protective relay equipment current input.
- 3] Connect the timer stop input (STOP) to the protective relay equipment trip output.
- 4] Also connect the separate 0-120 V AC voltage source to the voltmeter input.
- 5] If low currents are to be measured, connect the current source to the separate ammeter panel input.
- 6] Turn on power to SVERKER using the mains switch.
- 7] Activate the desired stop condition for the timer by setting the stop input for a make and/or break function and for a live or dead contact.
- 8] Activate extra measurement of P or Q by calling up and using a menu on the display as follows:
MODE- \blacktriangledown -' Ω , ϕ , W, VA...' -CHG- \blacktriangledown -P(W) or Q(VAr)-SEL-ESC, whereupon the following will be shown on the display:
ms-A-V m Ω .
- 9] Select the desired voltage range (0-60 or 60-120 V) for the separate AC voltage output by pressing the left button beneath the output.
- 10] Activate the AC voltage output by pressing the right button beneath the output. Then set the voltage.
- 11] Move the ammeter test point to the desired current output or to the separate ammeter panel input. This can be done step by step with the A button located to the right of the display window. When a test point is selected, its indicator lamp lights.

Pick-up and drop-out functions: P or Q > ON and P or Q > OFF

- 1] Turn on the SVERKER current source by activating ON with the start switch (press the \blacktriangledown key once), whereupon the ON indicator lamp will light.
- 2] Increase the current until operation takes place (P > or Q > ON), whereupon the

SVERKER TRIP indicator will glow steadily. If operation does not take place, reverse the polarity of the protective relay equipment voltage circuit.

- 3] Read the P > ON or Q > ON value on the display (U, I and P or Q).
- 4] If the freeze function has been activated, press the HOLD button twice to unfreeze the value shown.
- 5] Decrease the current until drop-out occurs (P > OFF or Q > OFF), whereupon the TRIP indicator will be extinguished.
- 6] Read the P > OFF or Q > OFF value from the display window.
- 7] Decrease the current to 0.
- 8] Turn off the SVERKER current source by setting the start switch to the OFF position.

Operating times: P > ON + TIME DELAY or Q > ON + TIME DELAY

- 1] Turn on the SVERKER current source by setting the start switch to the ON position, whereupon the ON indicator lamp will light.
- 2] Increase the current to $1.5 \times P > ON$.
- 3] Turn off the SVERKER current source by setting the start switch to the OFF position.
- 4] Activate ON + TIME by means of the start switch, whereupon the timer will start and the current source will start to generate current.
- 5] When the protective relay equipment operates, the timer will stop automatically and the current source will be turned off automatically, whereupon the TRIP indicator will start to flash.
- 6] Read the ON + TIME DELAY value from the SVERKER display.
- 7] Repeat the U > ON + TIME DELAY run two or three times to confirm its accuracy through repetition.
- 8] Decrease the current to 0.

Finishing the test

- 1] Enter the values read from the display into the test report.
- 2] Turn off power to SVERKER using the mains switch.
- 3] Disconnect the equipment.

7.5 Testing undervoltage relays

The following functions are to be tested:

- Pickup function: U < ON
- Drop-out function : U < OFF
- Operating time: U < ON + TIME DELAY

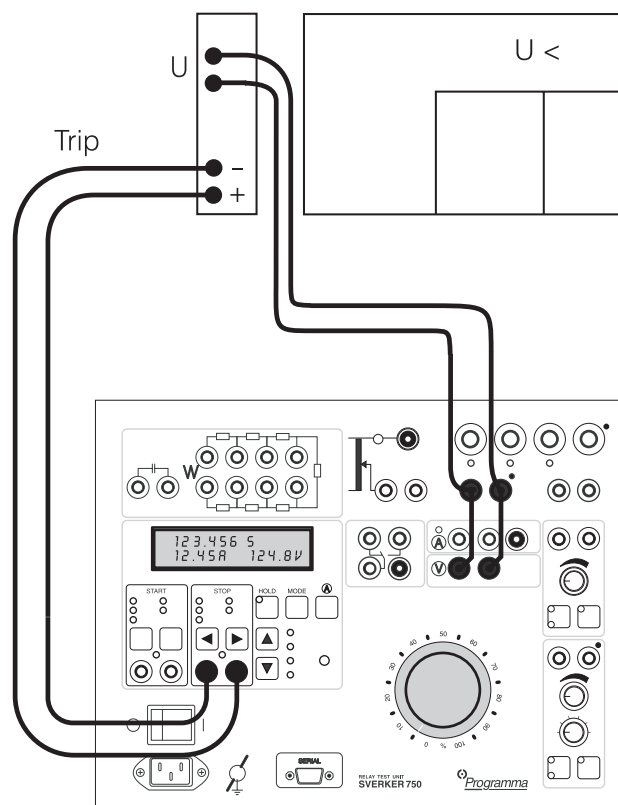

Test hook-up and initial settings

Connect for testing as shown in the above diagram.

- 1] Connect the 0-250 V AC voltage source output to the protective relay equipment.
- 2] Also connect this output to the voltmeter input.
- 3] Connect the timer stop input (STOP) to the relay trip/signal output.
- 4] Turn on power to SVERKER using the mains switch.
- 5] Activate the desired stop condition for the timer by setting the stop input for a make and/or break function and for a wet or dry contact.
- 6] If the display window is to freeze the voltage reading at trip/signal time, check to see that the HOLD function is active (it can be activated by means of the HOLD button).
- 7] If the 0-250 V AC output is considered not

sensitive enough, one of the following outputs can be selected: 0-10, 0-40 or 0-100 A. Alternatively, the voltage can be divided by means of the set of resistors included with the SVERKER.

Pick-up and drop-out functions: U < ON and U < OFF

- 1] Turn on the SVERKER current source by activating ON with the start switch (press the ▼ key once), whereupon the ON indicator lamp will light.
- 2] Increase the voltage to 1.1-1.2 x the relay voltage setting.
- 3] Decrease the voltage until operation occurs (U < ON), whereupon the SVERKER TRIP indicator will start to glow steadily.
- 4] Read the U < ON value from the display window.
- 5] If the freeze function has been activated, press the HOLD button twice to unfreeze the value shown.
- 6] Increase the voltage until drop-out takes place (U < OFF), whereupon the TRIP indicator will be extinguished.
- 7] Read the U < OFF value from the display window.

Operating time: U < ON + TIME DELAY

- 1] Turn on the SVERKER main source by setting the start switch to the ON position, whereupon the ON indicator lamp will light.
- 2] Increase the voltage to 1.1-1.2 times the relay voltage setting (1.1-1.2 x U < ON).
- 3] Activate OFF + TIME using the start switch (press the ▼ key), whereupon the main source stops to generate voltage and the timer starts .
- 4] When the protective relay equipment operates, the time stops automatically, whereupon the TRIP indicator starts to flash.
- 5] Read the U < ON + TIME DELAY value from the display window.
- 6] Repeat the U < ON + TIME DELAY run two or three times to confirm its accuracy through repetition.

Finishing the test

- 1] Enter the values read from the display into the test report.
- 2] Turn off power to SVERKER using the mains

switch.

- 3] Disconnect the equipment.

7.6 Testing motor overload releases and overcurrent cut-outs that grant/deny starting permission

Test equipment used for motor overload releases and overcurrent cut-outs that govern the granting or denial of starting permission must be able to provide both normal-operation current and fault current, and it must be possible to change between them without interrupting the test. Moreover, time measurement must start precisely when the change occurs.

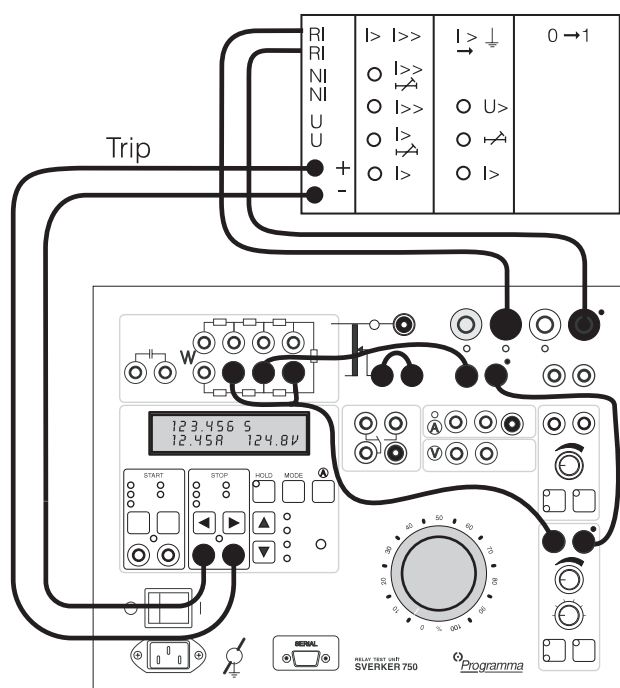

The SVERKER voltage source can supply the output transformer via a reverse circuit comprising two parallel-coupled resistors of 1000 Ω and 500 Ω . See illustration above.

- 1] The normal-operation current is set from the voltage source, and it can be varied from 0 up to 6 A, depending on the impedance of the release/cut-out and the current output that was selected.
- 2] The fault current is set in the usual way with the main knob.
- 3] To start test, press ON+TIME.

The normal-operation current changes to fault current and time measurement starts. This procedure provides you with the tripping times for the release/cut-out for a fault that occurs occurring during normal operation and also for a fault that prevents starting permission from being granted.

7.7 Testing frequency relays

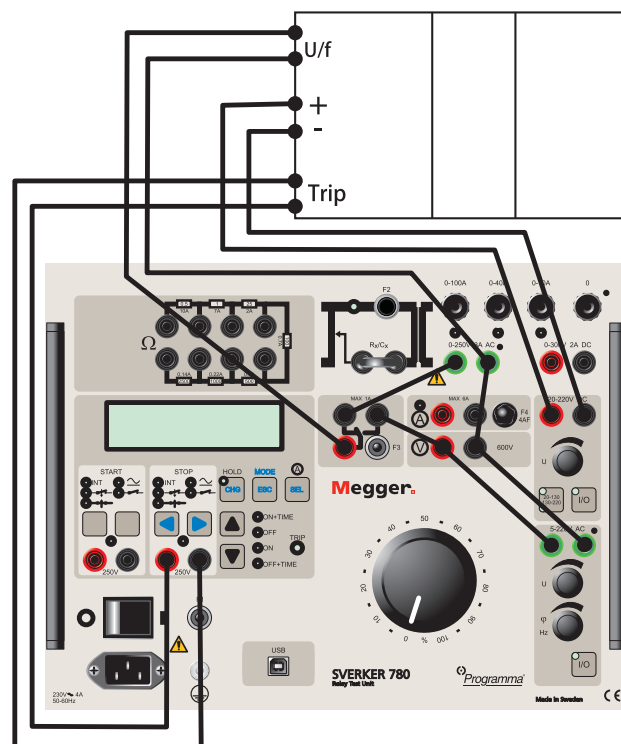

Make the connections as showed in the picture above.

- 1] Adjust the power supply with knob (28).
- 2] Adjust the nominal voltage for the pre-fault state using the main knob (7) for the 0-250 V AC output
- 3] Adjust the auxiliary AC output 5-220 V AC with knob (23) for the faulty state.
- 4] Press MODE to enter the Menu, scroll down to "Q, φ , W, VA..." (extra measurements) and choose "Frequency". Press ESC to exit the Menu.
- 5] Use the multi-functional knob (43) to adjust the frequency (faulty state). Press it to choose integer or decimal to be changed and turn it to left or right to decrease or increase the value.
- 6] Set trip conditions on STOP input (make or break and voltage or contact sense).
- 7] Press the \blacktriangledown key (ON) to start generating pre-fault. After a couple of seconds, press the \blacktriangledown key again to go to OFF+TIME and generate the fault.
- 8] Read the trip time on the display.

8

Troubleshooting

8.1 General

Fault	Possible cause	Remedy
No output current from SVERKER.	a) No mains voltage	Check that power cord is properly plugged in.
	b) Miniature circuit breaker F1 or F2 may have tripped.	Check miniature circuit breakers F1 and F2.
	c) The thermal cut-out may have tripped because of an overload.	This cut-out is reset automatically after a certain amount of time has elapsed.
The separate AC voltage source malfunctions.	The PTC resistor that serves as a thermal cut-out may have tripped because of an overload.	Wait. This cut-out is reset automatically after a certain amount of time has elapsed.
Auxiliary DC voltage source malfunctions.	The thermal cut-out (thermal relay) may have tripped because of an overload.	Wait. This cut-out is reset automatically after a certain amount of time has elapsed.
Make/break contact malfunctions.	Miniature circuit breaker F3 may have tripped.	Check the miniature circuit breaker.

8.2 Displayed values

Reading	Possible cause	Remedy
No current reading appears when measurements are made via the ammeter's panel input.	Miniature circuit breaker F4 may have tripped because the measured current exceeded 6 A.	Check the miniature circuit breaker.
Abnormal current readings are displayed.	The current is probably being measured at the wrong location (test point).	Check to see that the correct test point has been selected for the ammeter.
No voltage reading appears.	The voltmeter panel input is not connected.	Connect the voltmeter input.
Unexpectedly short operating times are shown.	Contact bounces are occurring in the protective relay equipment.	Connect the SVERKER capacitor in parallel with the test object.
Fewer than the desired number of times appear in the time table after measuring reclosings.	The "delay off" function is activated (time that elapses before generation is stopped) and start and stop pulses are issued during the "delay off" period.	Shorten the "delay off" period or set it to 0. See Chapter 5 entitled "Making settings in the display".
AC Voltage Source LED blinks	<ul style="list-style-type: none"> • Undervoltage on input • Overvoltage on input • Overcurrent on output • Main frequency is outside limits (40 to 80 Hz) 	Press I/O button (44) to disable output.
No phase-angle reading (or jumping values)	No current generated. Both current and voltage must be generated.	"Press ""ON"" to generate the current.

8.3 Error messages etc.

Reading	Possible cause	Remedy
Flashing value	The value shown is less than 1% of the range being used.	
O.F.	Means overflow and indicates that the range being used has been exceeded. One possible cause is that the measurement cycle proceeded to rapidly to permit the range to be switched automatically.	You should thus repeat the measurement. Since range switching data is stored in a memory, your second try may very well be successful.
----	No value can be displayed. This occurs (for example) in connection with cycles that are much too fast.	
BAD START CONDITION		Select another start condition.
BAD STOP CONDITION		Select another stop condition.
CHECKSUM ERROR	Internal fault in SVERKER.	Contact your closest Megger representative.
RAM ERROR	Internal fault in SVERKER.	Contact your closest Megger representative

9 Specifications

SPECIFICATIONS SVERKER 750/780

Specifications are valid at nominal input voltage and an ambient temperature of +25°C, (77°F). Specifications are subject to change without notice.

Environment

Application field The instrument is intended for use in high-voltage substations and industrial environments.

Temperature

Operating 0°C to +50°C (32°F to +122°F)
Storage & transport -40°C to +70°C (-40°F to +158°F)

Humidity 5% – 95% RH, non-condensing

CE-marking

LVD Low Voltage Directive 2006/95/EC
EMC EMC Directive 2004/108/EC

General

Mains voltage 115/230 V AC, 50/60 Hz
Power consumption (max) 1380 W
Protection Thermal cut-outs, automatic overload protection

Dimensions

Instrument 350 x 270 x 220 mm
 (13.8" x 10.6" x 8.7")
Transport case 610 x 350 x 275 mm
 (24.0" x 13.8" x 10.8")

Weight

SVERKER 750 17.3 kg (38.1 lbs)
 26.3 kg (58 lbs) with accessories and transport case
SVERKER 780 18.1 kg (39.9 lbs)
 27.1 kg (59.7 lbs) with accessories and transport case

Test lead set, with 4 mm stackable safety plugs 2 x 0.25 m (0.8 ft), 2.5 mm²
 2 x 0.5 m (1.6 ft), 2.5 mm²
 8 x 2.0 m (6.6 ft), 2.5 mm²

Test leads with spade tongue connectors 2 x 3.0 m (9.8 ft), 10 mm²

Display

LCD

Available languages Czech, English, French, German, Spanish, Swedish, Turkish

Measurement section

Timer

Time can be displayed in seconds or in mains-frequency cycles.

Range	Resolution	Inaccuracy
000-9.999 s	1 ms	±(1 ms + 0.01%)*
10.00-99.99 s	10 ms	±(10 ms + 0.01 %)*
100.0-999.9 s	100 ms	±(100 ms + 0.01 %)*

* For the OFF+TIME start condition in INT mode, 1 ms shall be added to the above measurement error.

Range	Resolution	Inaccuracy
0.0-999.9 cycles	0.1 cycles	±(0.1 cycles + 0.01%)
1000-49999 cycles at 50 Hz 1000-59999 cycles at 60 Hz	1 cycle	±(1 cycle + 0.01 %)

Ammeter

Measurement method

AC, true RMS
 DC, mean value

Ranges

Internal 0.00 – 250.0 A
External 0.000 – 6.000 A

Inaccuracy

Internal range ¹⁾
 0–10 A AC ±(1% + 20 mA)
 0–40 A AC ±(1% + 40 mA)
 0–100 A AC ±(1% + 200 mA)
External range ¹⁾
 0–0.6 A AC ±(1% + 20 mA)
 0–6 A AC ±(1% + 20 mA)
 0–0.6 A DC ±(0.5% + 2 mA)
 0–6 A DC ±(0.5% + 20 mA)

Resolution

Internal range 10 mA (range <100 A)
 100 mA (range >100 A)
External range 1 mA

Voltmeter

Measurement method AC, true RMS
 DC, mean value
Range 0.00 – 600.0 V
Inaccuracy ¹⁾ AC, ±(1% + 200 mV) Max. value
 DC, ±(0.5% + 200 mV) Max. value
 Values are range depending

Extra measurements

Power factor and phase angle measurements

	Range	Resolution	Inaccuracy
Power factor cos φ	-0.99 (cap) to +0.99 (ind)	0.01	±0.04
Phase angle φ (°)	000 – 359°	1°	±2°

Impedance and power measurements

AC Z (Ω and °), Z (Ω), R and X (Ω and Ω), P (W), S (VA), Q (VAR)

DC R (Ω), P (W)

Range Up to 999 kX (X= unit)

Make/Break contact

Max. current 1 A
Max. voltage 250 V AC or 120 V DC

Reclosing test

Items measured Tripping and reclosing times
Display After test is finished a list of all times appears in display

Breaker state feedback The Make/Break contact can be used to feed back the breaker state

Max. number of reclosings 49

Max. testing time 999 s

Sets of resistors and a capacitor

Resistors 0.5 Ω to 2.5 kΩ
Capacitor ²⁾ 10 μF, max voltage 450 V AC

1) Measurement intervals longer than 100 ms

2) SVERKER 750

Outputs

Current outputs – AC

Range	No-load voltage (min)	Full-load voltage (min)	Full-load current (max)	Load/unload times On (max)/Off (min)
0 – 10 A	90 V	75 V	10 A	2/15 minutes
0 – 40 A	25 V	20 V	40 A	1/15 minutes
0 – 100 A	10 V	8 V	100 A	1/15 minutes
0 – 100 A	10 V	-	250 A* 200 A**	1 sec/5 minutes

* Mains voltage 230 V AC
** Mains voltage 115 V AC

Voltage outputs – AC/DC

Range	No-load voltage (min)	Full-load voltage (min)	Full-load current (max)	Load/unload times On (max)/Off (min)
0 – 250 V AC	290 V AC	250 V AC	3 A	10 min/45 min
0 – 300 V DC	320 V DC	250 V DC	2 A	10 min/45 min

Separate AC voltage source SVERKER 750

Range	No-load voltage (min)	Full-load voltage (min)	Full-load current (max)
0 – 60 V AC	70 V	60 V	0.25 A
60 – 120 V AC	130 V	120 V	0.25 A

Both ranges are divided into voltage steps of 10 V that are steplessly variable.

Separate AC voltage source SVERKER 780

Range	No-load voltage (min)	Full-load voltage (min)	Full-load power (max)
5 – 220 V AC minimum step 0.1 V	240 V AC	220 V AC at 33 W 200 V AC at 46 W	33 W continuously. 46 W 1 minute

Phase angle	Resolution	Inaccuracy
0 – 359°	1°	±2°
Frequency	Resolution	Inaccuracy
15 – 550 Hz	1 mHz	±0.1%

Auxiliary DC output

Range	Voltage	Max. current
20 – 130 V DC	20 V DC 130 V DC	300 mA 375 mA
130 – 220 DC	130 V DC 220 V DC	325 mA 400 mA

Specifications extended**Maximum load times for different currents**

Range (A AC)	Current used (A AC)	Load time, maximum	Recovery time, minimum (minutes)
100	200	1 s (3 times)	5
	150	3 s (5 times)	10
	100	1 minute	15
	75	10 minutes	45
	50	30 minutes	100
	30	Continuous	-
40	80	1 s (3 times)	5
	60	3 s (5 times)	10
	40	1 minute	15
	30	10 minutes	45
	20	30 minutes	100
	12	Continuous	-
10	20	2 s (3 times)	5
	15	5 s (5 times)	10
	10	2 minutes	15
	7.5	15 minutes	45
	5	Continuous	-

The voltage outputs of the current source

The DC voltage output provides rectified, smoothed AC. The maximum current should not be used while any of the current outputs are being used.

Note *Time-limited (max-time) generation should be used for times shorter than 1 minute.*

Separate AC voltage source

This output is protected by a PTC resistor.

Moreover, it is equipped with two 400 V transient voltage suppressors (transils). One is located between the output contacts, and the other between the output contact marked with a dot and ground (earth).

Auxiliary DC voltage output

The auxiliary voltage output is stabilized and also short circuit proof. Moreover, it is equipped with two 400 V transient voltage suppressors (transils). One is located between the output contacts, and the other between the black output contact and ground (earth). The respective max currents can be used continuously at high output voltages in either of the two ranges. When the respective max currents are used at low voltages in either range, a temperature monitor will trip after a while, and the voltage will be shut off. However, the voltage will be restored as the temperature drops.

Inputs

Timer inputs

These inputs are equipped with 400 V transient voltage suppressors (transils) at three locations:

- Between the input contacts.
- Between the black input contact and ground (earth).
- Between the red input contact and ground (earth).

Potential state

Parameter	Min	Type	Max	Unit
High changeover level, DC, $ V_{IH} DC$	20			V DC
Low changeover level, DC, $ V_{IL} DC$			5	V DC
High voltage level, AC, $ V_{IH} AC^{1)}$	60			V ACrms
Low voltage level, AC, $ V_{IL} AC$			3	
V ACrms Input current at high level, AC/DC, $ I_{IH} $	1		5	mA

1) This high voltage is needed to provide correct time readings

Contact state

Parameter	Min	Type	Max	Unit
High changeover resistance, R_{IH}	3			k Ω
Low changeover resistance, R_{IL}			750	Ω
Output current with short-circuited input	7		13	mA DC
Internal supply voltage, V_s		20		V DC

Maximum values

Parameter	Max	Unit
Max input voltage, DC, $ V_{IN} DC$	275	V DC
Max input voltage, AC, $ V_{IN} AC$	250	V ACrms

Make/Break contact

The make/break contact is equipped with a 1 A miniature circuit breaker

Make/break contact 400 V transient voltage suppressors (transils) are provided at three locations:

- Between common contact and ground.
- Between common contact and break contact.
- Between common contact and make contact.

Normal use

Function	Time error between current and the make/break contact
Current start	± 1 ms (max)
Current end	0–10 ms

Breaker state simulation

Function	Time error between current and the make/break contact
Current start (reclosing)	± 1 ms (max)
Current end (trip)	0–30 ms

Measurement section

Ammeter

Switching between ranges can be carried out either automatically or manually as desired.

The measured current can be displayed in amperes or as a percentage of a presettable nominal value.

AC current is measured as true RMS.

DC current is measured as a mean value.

The external current measurement input is protected by a 4 A fuse designed to withstand a current of up to 6 A for a duration of one hour.

The values specified below are for measurement intervals (times) longer than 100 ms. The measurement error is greater for shorter measurement intervals.

Specifications for current in amperes

Test-point	Range	Resolution	Inaccuracy (% of reading + mA)
0-10 A	2 A AC	0.10–1.99 A: 10 mA	$\pm(1\% + 10 \text{ mA})$
	20 A AC	2.00–19.99 A: 10 mA	$\pm(1\% + 20 \text{ mA})$
0-40 A	8 A AC	0.40–7.99 A: 10 mA	$\pm(1\% + 10 \text{ mA})$
	80 A AC	8.00–79.99 A: 10 mA	$\pm(1\% + 80 \text{ mA})$
0-100 A	20 A AC	1.00–19.99 A: 10 mA	$\pm(1\% + 20 \text{ mA})$
	200 A AC	20.00–99.99 A: 10 mA 100.0–249.9 A: 100 mA	$\pm(1\% + 200 \text{ mA})$
External	0.6 A AC	0.000–0.599 A: 1 mA	$\pm(1\% + 2 \text{ mA})$
	6 A AC	0.600–5.999 A: 1 mA	$\pm(1\% + 20 \text{ mA})$
	0.6 A DC	0.000–0.599 A: 1 mA	$\pm(0.5\% + 2 \text{ mA})$
	6 A DC	0.600–5.999 A: 1 mA	$\pm(0.5\% + 20 \text{ mA})$

Specifications for current displayed as a percentage of a presettable nominal value

Resolution Percentage	Resolution Nominal value	Inaccuracy
000–999%: 1%	000-999 A: 1 A	$\pm 1\%$

Voltmeter

Switching between ranges can be carried out either automatically or manually as desired.

The measured voltage can be displayed in volts or as a percentage of a presettable nominal value.

AC voltage is measured as a true RMS.

DC voltage is measured as a mean value.

The input is protected by a PTC resistor, and input resistance R_{in} is 220 k Ω .

The values specified below are for measurement intervals (times) longer than 100 ms. The measurement error is greater for shorter measurement intervals.

Specifications for voltage displayed in volts

Range	Resolution	Inaccuracy (% of reading + mV)
6 V AC	0.00–5.999 V: 10 mV	$\pm(1\% + 10 \text{ mV})$
60 V AC	6.00–59.99 V: 10 mV	$\pm(1\% + 20 \text{ mV})$
600 V AC	60.00–99.99 V: 10 mV 100.0–599.9 V: 100 mV	$\pm(1\% + 200 \text{ mV})$
6 V DC	0.00–5.99 V: 10 mV	$\pm(0.5\% + 10 \text{ mV})$
60 V DC	6.00–59.99 V: 10 mV 60.00–99.99 V: 10 mV	$\pm(0.5\% + 20 \text{ mV})$
600 V DC	100.0–599.9 V: 100 mV	$\pm(0.5\% + 200 \text{ mV})$

Specifications for voltage displayed as a percentage of a presettable nominal value

Resolution Percentage	Resolution Nominal value	Inaccuracy
000–999%: 1%	000–999 V: 1 V	$\pm 1\%$

Reclosing test

Maximum number of reclosings	Max testing time for all reclosings	Resolution at max testing time
49 times	999 s	1 s

Extra measurements

Power factor and phase angle measurements

The following specifications are for voltages and current readings that are higher than 10% of the selected range.

Item and unit	Range	Resolution	Inaccuracy
Power factor $\cos \phi$	-0.99 (cap) to +0.99 (ind)	0.01	± 0.04
Phase angle ϕ ($^\circ$)	000–359	1 $^\circ$	$\pm 2^\circ$

The following items can be measured for AC:

- $\cos \phi$
- ϕ ($^\circ$) with current as reference (I_{ref})
- ϕ ($^\circ$) with voltage as reference ($^\circ$, U_{ref})

Impedance and power measurements

For these measurements, the result is calculated using 2 or 3 items. The measurement error obtained depends on the measurement errors for the items included (U , I and sometimes ϕ).

Range (X represents one of the items listed below)	Resolution
000–999 mX	0.001
1.00–9.99 X	0.01
10.0–99.9 X	0.1
100–999 X	1
1.00–9.99 kX	10
10.0–99.9 kX	100
100–999 kX	1000

For AC, the following items (X above) can be measured:

- Z (Ω and $^\circ$)
- Z (Ω)
- R and X (Ω and Ω)
- P (W)
- S (VA)
- Q (VAR)

For DC, the following items (X above) can be measured:

- R (Ω)
- P (W)

Other

Injection

Maintained	Injection continues without any time limitation.
Momentary	Injection continues only as long as the button is kept depressed. Minimum momentary injection time is 0.1 s.
Max time	Injection stops automatically when the preset maximum time is reached. Max injection time 99.9 s Resolution at max time 0.1 s

Filtering

If filtering was selected, five successive readings are averaged. The following can be filtered:

- Current
- Voltage
- Extra items that are measured

Off delay

The turning off of generation can be delayed after tripping throughout a specified time interval that is expressed in mains-frequency cycles.

Max off delay	999 mains-frequency cycles
Resolution at max off delay	1 cycle

Memories

There are four memories numbered 0 through 3.

Environment

Installation category	II (2.5 kV)
Pollution degree	2
Altitude	Max 2000 m

Set of resistors

Resistor ohmage	Max current
0.5 Ω	10 A
1 Ω	7 A
25 Ω	2 A
100 Ω	0.7 A
500 Ω	0.3 A
1 k Ω	0.22 A
2.5 k Ω	0.11 A

Index

Symbols

0-Level filter35

A

AC Voltage source 15, 23

Ammeter32

Ammeter & voltmeter 14, 23

Application examples54

Automatic recloser50

Auxiliary voltage46

Auxiliary voltage source 15, 24

B

Break contact..... 16, 24

Button functions.....29

C

Capacitor..... 16, 25

Computer interface..... 17

Control panel..... 18

Current source..... 11, 20

D

Directional ground-fault relay syste57

Directional overcurrent relay.....57

Direction indicator29

Display..... 13, 22, 34

E

External cycle time49

F

Finding pick-up and drop-out limits.....42

G

Generating higher voltages45

H

High currents40

I

Injecting current.....38

Injection.....32

J

K

L

Language.....37

Low currents.....40

M

Magnetization curve50

Make/Break contact 16, 24

Making settings28

Measuring current39

Measuring voltage44

Menu system30

N

Numerical value29

O

Off delay.....35

Operate38

Operating times.....43, 44

Overcurrent relays55

P

Phase angle45, 48

Phase difference47

Pick-up and drop-out limits41

Power relays60

Power supply 17, 25

Q

R

Recall.....36

Remote control36

Resistor set and capacitor..... 16

S

Save/Recall.....36

Select current output39

Set of resistors and capacitor25

Setting mode28

Setting the desired current.....40

Software37

Specifications.....66

SW37

Symbols on the instrument6

T

Testing directional over-current relay57

Testing frequency relays63

Testing motor overload releases63

Testing over-current relays.....	55
Testing power relays.....	60
Testing under- voltage relays	61
Testing voltage relays	54
Test mode	31
Timer	12, 21, 34
Start conditions	12
Stop conditions.....	12
Trip indicator.....	13, 22
Trip pulse length	51
Troubleshooting	64

U

Undervoltage relays	61
---------------------------	----

V

Voltage relays	46, 54
Voltage source	15, 23
Voltmeter.....	14, 23, 33

W

X

Y

Z



Local Sales office

Visit: www.megger.com

Manufacturing sites

Megger Limited

Archcliffe Road

Dover

Kent

CT17 9EN

ENGLAND

T. +44 (0)1 304 502101

F. +44 (0)1 304 207342

Megger GmbH

Weststraße 59

52074 Aachen

T. +49 (0) 241 91380 500

E. info@megger.de

Megger USA - Valley Forge

Valley Forge Corporate Center

2621 Van Buren Avenue

Norristown

Pennsylvania, 19403

USA

T. +1 610 676 8500

F. +1 610 676 8610

Megger USA - Dallas

4545 West Davis Street

Dallas TX 75237

USA

T. 800 723 2861 (USA only)

T. +1 214 333 3201

F. +1 214 331 7399

E. USsales@megger.com

Megger AB

Rinkebyvägen 19, Box 724,

SE-182 17 DANDERYD

SWEDEN

T. +46 08 510 195 00

E. seinfo@megger.com

Megger USA - Fort Collins

4812 McMurry Avenue

Suite 100

Fort Collins CO 80525

USA

T. +1 970 282 1200

This instrument is manufactured in SWEDEN.

The company reserves the right to change the specification or design without prior notice.

Megger is a registered trademark

© Megger Limited 2023

www.megger.com